

SOT-363 Plastic-Encapsulate MOSFETS

2N7002KDW N-channel MOSFET

$V_{(BR)DSS}$	$R_{DS(on)MAX}$	I_D
60V	2.5Ω@10V	340mA
	3Ω@4.5V	

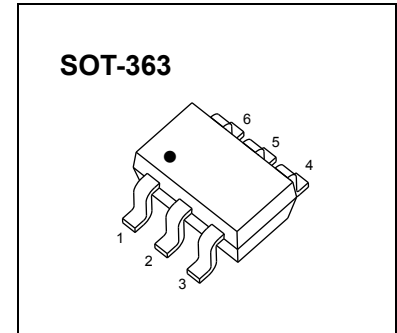

FEATURE

- High density cell design for Low $R_{DS(on)}$
- Voltage controlled small signal switch
- Rugged and reliable
- High saturation current capability
- ESD protected

APPLICATION

- Load Switch for Portable Devices
- DC/DC Converter

MARKING

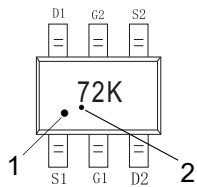

72K=Device code
 Solid dot1=Pin1 indicator
 Solid dot2= Green molding compound device.

Equivalent Circuit

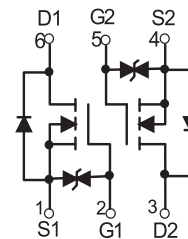

MOSFET MAXIMUM RATINGS ($T_a = 25^\circ\text{C}$ unless otherwise noted)

Symbol	Parameter	Value	Unit
V_{DS}	Drain-Source voltage	60	V
V_{GS}	Gate-Source voltage	±20	V
I_D	Drain Current	340	mA
P_D	Power Dissipation	0.15	W
T_J	Junction Temperature	150	°C
T_{stg}	Storage Temperature	-55-150	°C
$R_{\theta JA}$	Thermal Resistance from Junction to Ambient	833	°C /W

MOSFET ELECTRICAL CHARACTERISTICS

$T_a = 25\text{ }^\circ\text{C}$ unless otherwise specified

Parameter	Symbol	Test Condition	Min	Typ	Max	Units
Static Characteristics						
Drain-Source Breakdown Voltage	V_{DS}	$V_{GS} = 0V, I_D = 250\mu A$	60			V
Gate Threshold Voltage*	$V_{GS(th)}$	$V_{DS} = V_{GS}, I_D = 1mA$	1	1.3	2.5	V
Zero Gate Voltage Drain Current	I_{DSS}	$V_{DS} = 48V, V_{GS} = 0V$			1	μA
Gate –Source leakage current	I_{GSS1}	$V_{GS} = \pm 20V, V_{DS} = 0V$			± 10	μA
Drain-Source On-Resistance*	$R_{DS(on)}$	$V_{GS} = 4.5V, I_D = 200mA$		1.1	3	Ω
		$V_{GS} = 10V, I_D = 500mA$		0.9	2.5	Ω
Diode Forward Voltage	V_{SD}	$V_{GS} = 0V, I_S = 300mA$			1.5	V
Recovered charge	Q_r	$V_{GS} = 0V, I_S = 300mA, V_R = 25V,$ $di_S/dt = -100A/\mu s$		30		nC
Dynamic Characteristics**						
Input Capacitance	C_{iss}	$V_{DS} = 10V, V_{GS} = 0V, f = 1MHz$			40	pF
Output Capacitance	C_{oss}				30	pF
Reverse Transfer Capacitance	C_{rss}				10	pF
Switching Characteristics**						
Turn-On Delay Time	$t_{d(on)}$	$V_{GS} = 10V, V_{DD} = 50V, R_G = 50\Omega,$ $R_{GS} = 50\Omega, R_L = 250\Omega$			10	ns
Turn-Off Delay Time	$t_{d(off)}$				15	ns
Reverse recovery Time	t_{rr}	$V_{GS} = 0V, I_S = 300mA, V_R = 25V,$ $di_S/dt = -100A/\mu s$		30		ns
GATE-SOURCE ZENER DIODE						
Gate-Source Breakdown Voltage	BV_{GSO}	$I_{GS} = \pm 1mA$ (Open Drain)	± 21.5		± 30	V

Notes :

*Pulse Test : Pulse Width $\leq 300\mu s$, Duty Cycle $\leq 2\%$.

**These parameters have no way to verify.

Typical Characteristics

Output Characteristics

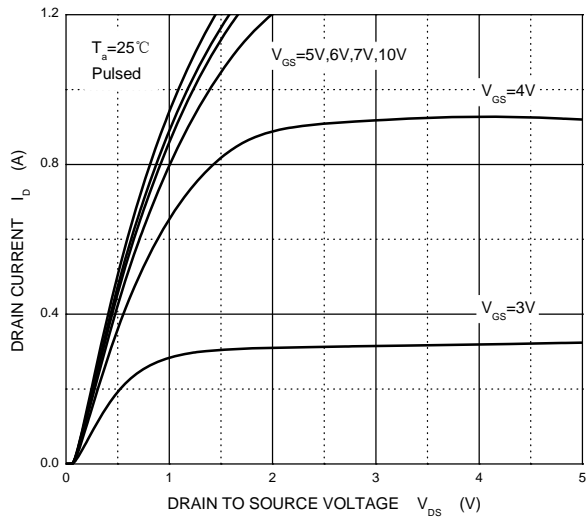

Transfer Characteristics

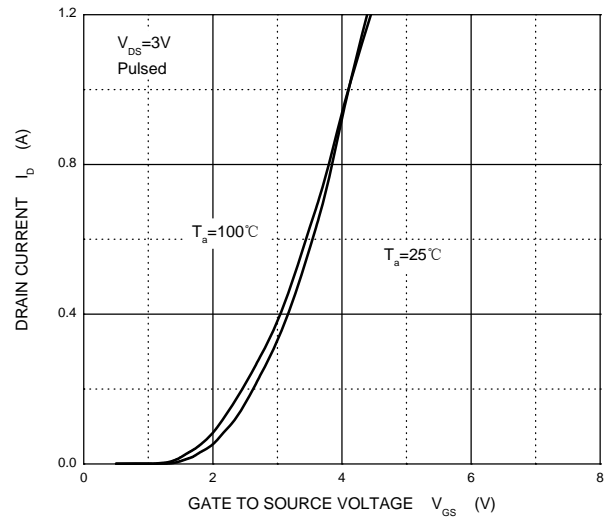

$R_{DS(ON)}$ — I_D

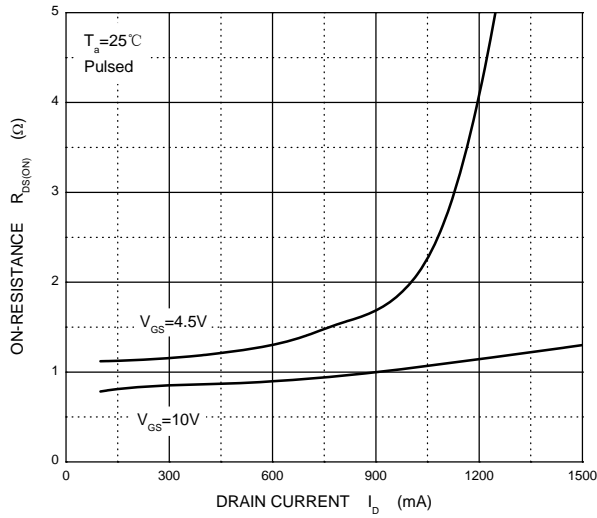

$R_{DS(ON)}$ — V_{GS}

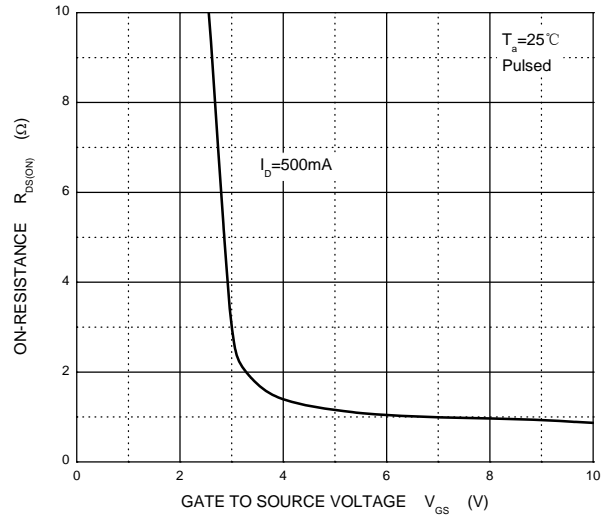

I_S — V_{SD}

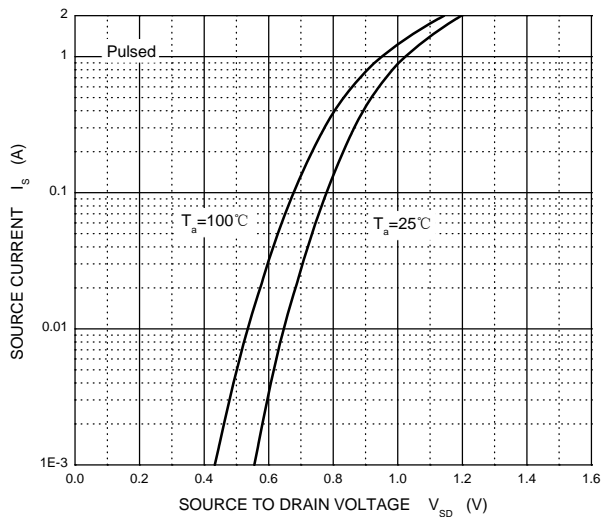

Threshold Voltage

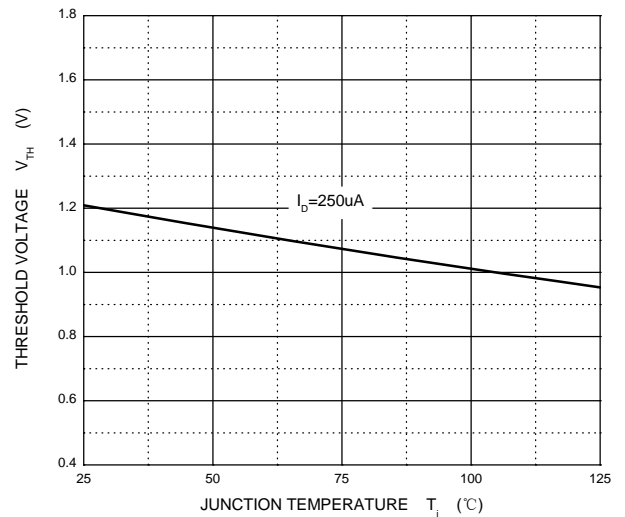

SOT-363 Package Outline Dimensions

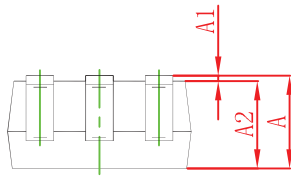
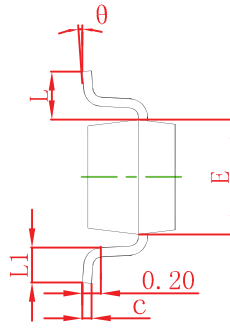
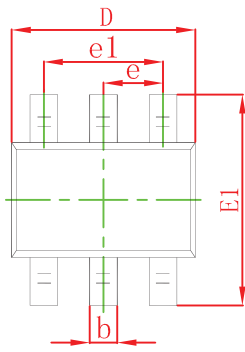

Symbol	Dimensions In Millimeters		Dimensions In Inches	
	Min	Max	Min	Max
A	0.900	1.100	0.035	0.043
A1	0.000	0.100	0.000	0.004
A2	0.900	1.000	0.035	0.039
b	0.150	0.350	0.006	0.014
c	0.100	0.150	0.004	0.006
D	2.000	2.200	0.079	0.087
E	1.150	1.350	0.045	0.053
E1	2.150	2.400	0.085	0.094
e	0.650 TYP		0.026 TYP	
e1	1.200	1.400	0.047	0.055
L	0.525 REF		0.021 REF	
L1	0.260	0.460	0.010	0.018
θ	0°	8°	0°	8°

SOT-363 Suggested Pad Layout

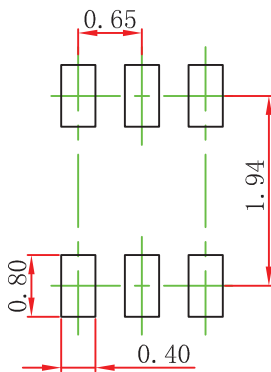

Note:

1. Controlling dimension: in millimeters.
2. General tolerance: $\pm 0.05\text{mm}$.
3. The pad layout is for reference purposes only.

NOTICE

JSCJ reserves the right to make modifications, enhancements, improvements, corrections or other changes without further notice to any product herein. JSCJ does not assume any liability arising out of the application or use of any product described herein.

SOT-363 Tape and Reel

SOT-363 Embossed Carrier Tape

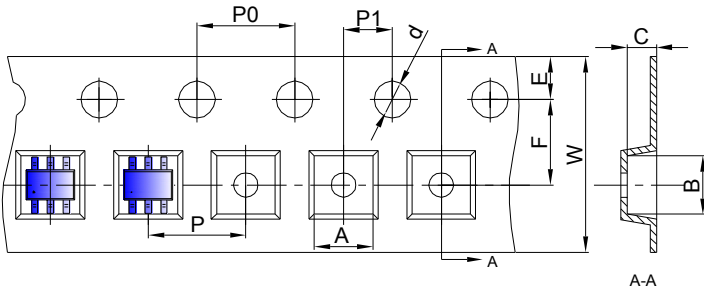

Packaging Description:

SOT-363 parts are shipped in tape. The carrier tape is made from a dissipative (carbon filled) polycarbonate resin. The cover tape is a multilayer film (Heat Activated Adhesive in nature) primarily composed of polyester film, adhesive layer, sealant, and anti-static sprayed agent. These reeled parts in standard option are shipped with 3,000 units per 7" or 17.8cm diameter reel. The reels are clear in color and is made of polystyrene plastic (anti-static coated).

Dimensions are in millimeter

Pkg type	A	B	C	d	E	F	P0	P	P1	W
SOT-363	2.25	2.55	1.20	Ø1.50	1.75	3.50	4.00	4.00	2.00	8.00

SOT-363 Tape Leader and Trailer

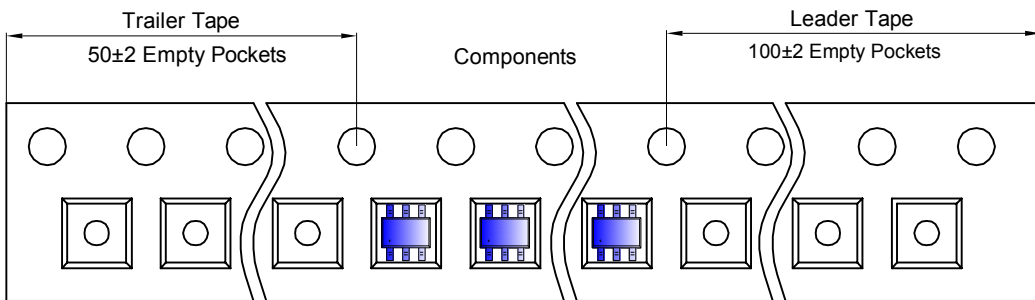

SOT-363 Reel

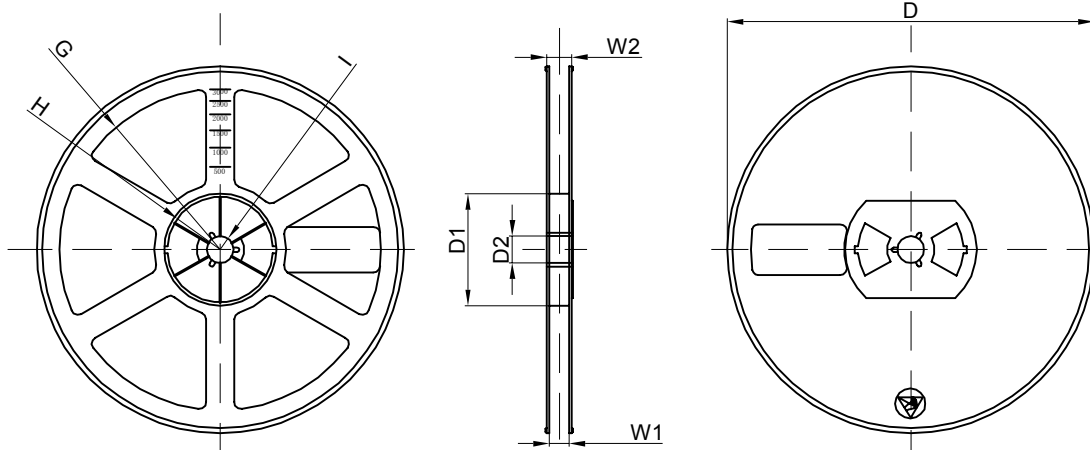

Dimensions are in millimeter

Reel Option	D	D1	D2	G	H	I	W1	W2
7" Dia	Ø178.00	54.40	13.00	R78.00	R25.60	R6.50	9.50	12.30

REEL	Reel Size	Box	Box Size(mm)	Carton	Carton Size(mm)	G.W.(kg)
3000 pcs	7 inch	45,000 pcs	203×203×195	180,000 pcs	438×438×220	