

R-6 Plastic-Encapsulate Diodes

5KP SERIES Transient Voltage Suppressor Diodes

Features

- P_{PP} 5000W
- V_{RWM} 5V- 188V
- Glass passivated chip

Applications

- Clamping Voltage

Marking

- 5KP XXA/CA

XX : From 5.0 To 188

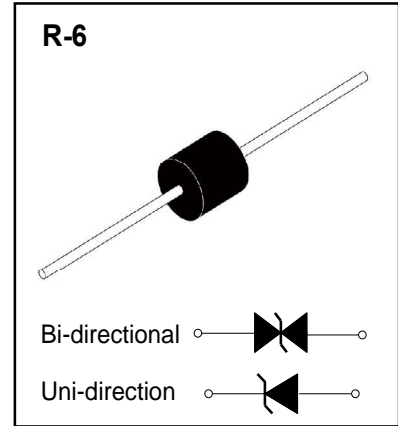

Limiting Values (Absolute Maximum Rating)

Item	Symbol	Unit	Conditions	Max
Peak pulse power dissipation	P_{PPM}	W	with a 10/1000us waveform	5000
Peak pulse current (1)	I_{PPM}	A	with a 10/1000us waveform	See Next Table
Power dissipation	P_D	W	On infinite heat sink at $T_L=75^\circ\text{C}$	8.0
Peak forward surge current(2)	I_{FSM}	A	8.3 ms single half sine-wave unidirectional only	500
Operation Junction and Storage Temperature Range	T_J, T_{STG}	$^\circ\text{C}$		-55 ~ +150

Electrical Characteristics ($T_a=25^\circ\text{C}$ Unless otherwise specified)

Item	Symbol	Unit	Conditions	Max
Maximum instantaneous forward Voltage (3)	V_F	V	at 100A for unidirectional only	3.5

Notes:

(1) $V_F < 3.5\text{V}$ for $V_{BR} < 200\text{V}$ and $V_F < 6.5\text{V}$ for $V_{BR} > 201\text{V}$

Electrical Characteristics ($T_A=25^{\circ}\text{C}$ unless otherwise noted)

Part Number(U ni)	Part Number(Bi)	Breakdown Voltage $V_{BR}@I_T$			Maximum Reverse Leakage $I_R @ V_{WM} (\mu A)$	Working Peak Reverse Voltage $V_{RWM} (V)$	Maximum Reverse Surge Current $I_{PP} (A)$	Maximum Clamping Voltage $V_c @ I_{PP} (V)$	Maximum Temperature Coefficient of $V_{BR} (\%/^{\circ}\text{C})$
		Min(V)	Max (V)	$I_T(\text{mA})$					
5KP5.0	5KP5.0C	6.40	7.30	50	2000	5.0	521	9.6	0.057
5KP5.0A	5KP5.0CA	6.40	7.00	50	2000	5.0	543	9.2	0.057
5KP6.0	5KP6.0C	6.67	8.15	50	5000	6.0	439	11.4	0.061
5KP6.0A	5KP6.0CA	6.67	7.37	50	5000	6.0	485	10.3	0.061
5KP6.5	5KP6.5C	7.22	8.82	50	2000	6.5	407	12.3	0.065
5KP6.5A	5KP6.5CA	7.22	7.98	50	2000	6.5	446	11.2	0.065
5KP7.0	5KP7.0C	7.78	9.51	50	1000	7.0	376	13.3	0.068
5KP7.0A	5KP7.0CA	7.78	8.60	50	1000	7.0	417	12.0	0.068
5KP7.5	5KP7.5C	8.33	10.2	5.0	250	7.5	350	14.3	0.073
5KP7.5A	5KP7.5CA	8.33	9.21	5.0	250	7.5	388	12.9	0.073
5KP8.0	5KP8.0C	8.89	10.9	5.0	150	8.0	333	15.0	0.075
5KP8.0A	5KP8.0CA	8.89	9.83	5.0	150	8.0	368	13.6	0.075
5KP8.5	5KP8.5C	9.44	11.5	5.0	50	8.5	314	15.9	0.078
5KP8.5A	5KP8.5CA	9.44	10.4	5.0	50	8.5	347	14.4	0.078
5KP9.0	5KP9.0C	10.0	12.2	5.0	20	9.0	296	16.9	0.081
5KP9.0A	5KP9.0CA	10.0	11.1	5.0	20	9.0	325	15.4	0.081
5KP10	5KP10C	11.1	13.6	5.0	15	10.0	266	18.8	0.084
5KP10A	5KP10CA	11.1	12.3	5.0	15	10.0	294	17.0	0.084
5KP11	5KP11C	12.2	14.9	5.0	10	11.0	249	20.1	0.086
5KP11A	5KP11CA	12.2	13.5	5.0	10	11.0	275	18.2	0.086
5KP12	5KP12C	13.3	16.3	5.0	5.0	12.0	227	22.0	0.088
5KP12A	5KP12CA	13.3	14.7	5.0	5.0	12.0	251	19.9	0.088
5KP13	5KP13C	14.4	17.6	5.0	2.0	13.0	210	23.8	0.090
5KP13A	5KP13CA	14.4	15.9	5.0	2.0	13.0	233	21.5	0.090
5KP14	5KP14C	15.6	19.1	5.0	2.0	14.0	194	25.8	0.092
5KP14A	5KP14CA	15.6	17.2	5.0	2.0	14.0	216	23.2	0.092
5KP15	5KP15C	16.7	20.4	5.0	2.0	15.0	186	26.9	0.094
5KP15A	5KP15CA	16.7	18.5	5.0	2.0	15.0	205	24.4	0.094
5KP16	5KP16C	17.8	21.8	5.0	2.0	16.0	174	28.8	0.096
5KP16A	5KP16CA	17.8	19.7	5.0	2.0	16.0	192	26.0	0.096
5KP17	5KP17C	18.9	23.1	5.0	2.0	17.0	164	30.5	0.097
5KP17A	5KP17CA	18.9	20.9	5.0	2.0	17.0	181	27.6	0.097
5KP18	5KP18C	20.0	24.4	5.0	2.0	18.0	155	32.2	0.098
5KP18A	5KP18CA	20.0	22.1	5.0	2.0	18.0	171	29.2	0.098
5KP20	5KP20C	22.2	27.1	5.0	2.0	20.0	140	35.8	0.099
5KP20A	5KP20CA	22.2	24.5	5.0	2.0	20.0	154	32.4	0.099

Electrical Characteristics ($T_A=25^\circ\text{C}$ unless otherwise noted)

Part Number(U ni)	Part Number(Bi)	Breakdown Voltage $V_{BR}@I_T$			Maximum Reverse Leakage $I_R @ V_{WM} (\mu\text{A})$	Working Peak Reverse Voltage $V_{RWM}(V)$	Maximum Reverse Surge Current IPP (A)	Maximum Clamping Voltage $V_c @ I_{PP}(V)$	Maximum Temperature Coefficient of $V_{BR} (\%/^\circ\text{C})$
		Min(V)	Max (V)	$I_T(\text{mA})$					
5KP22	5KP22C	24.4	29.8	5.0	2.0	22.0	127	39.4	0.100
5KP22A	5KP22CA	24.4	26.9	5.0	2.0	22.0	141	35.5	0.100
5KP24	5KP24C	26.7	32.6	5.0	2.0	24.0	116	43.0	0.101
5KP24A	5KP24CA	26.7	29.5	5.0	2.0	24.0	129	38.9	0.101
5KP26	5KP26C	28.9	35.3	5.0	2.0	26.0	107	46.6	0.101
5KP26A	5KP26CA	28.9	31.9	5.0	2.0	26.0	119	42.1	0.101
5KP28	5KP28C	31.1	38.0	5.0	2.0	28.0	100	50.1	0.102
5KP28A	5KP28CA	31.1	34.4	5.0	2.0	28.0	110	45.4	0.102
5KP30	5KP30C	33.3	40.7	5.0	2.0	30.0	93.5	53.5	0.103
5KP30A	5KP30CA	33.3	36.8	5.0	2.0	30.0	103	48.4	0.103
5KP33	5KP33C	36.7	44.9	5.0	2.0	33.0	84.7	59.0	0.104
5KP33A	5KP33CA	36.7	40.6	5.0	2.0	33.0	93.8	53.3	0.104
5KP36	5KP36C	40.0	48.9	5.0	2.0	36.0	77.8	64.3	0.104
5KP36A	5KP36CA	40.0	44.2	5.0	2.0	36.0	86.1	58.1	0.104
5KP40	5KP40C	44.4	54.3	5.0	2.0	40.0	70.0	71.4	0.105
5KP40A	5KP40CA	44.4	49.1	5.0	2.0	40.0	77.5	64.5	0.105
5KP43	5KP43C	47.8	58.4	5.0	2.0	43.0	65.2	76.7	0.105
5KP43A	5KP43CA	47.8	52.8	5.0	2.0	43.0	72.0	69.4	0.105
5KP45	5KP45C	50.0	61.1	5.0	2.0	45.0	62.3	80.3	0.106
5KP45A	5KP45CA	50.0	55.3	5.0	2.0	45.0	68.8	72.7	0.106
5KP48	5KP48C	53.3	65.2	5.0	2.0	48.0	58.5	85.5	0.106
5KP48A	5KP48CA	53.3	58.9	5.0	2.0	48.0	64.6	77.4	0.106
5KP51	5KP51C	56.1	69.3	5.0	2.0	51.0	54.9	91.1	0.107
5KP51A	5KP51CA	56.7	62.7	5.0	2.0	51.0	60.7	82.4	0.107
5KP54	5KP54C	60.0	73.3	5.0	2.0	54.0	51.9	96.3	0.107
5KP54A	5KP54CA	60.0	66.3	5.0	2.0	54.0	57.4	87.1	0.107
5KP58	5KP58C	64.4	78.7	5.0	2.0	58.0	48.5	103	0.107
5KP58A	5KP58CA	64.4	71.2	5.0	2.0	58.0	53.4	94	0.107
5KP60	5KP60C	66.7	81.5	5.0	2.0	60.0	46.7	107	0.108
5KP60A	5KP60CA	66.7	73.7	5.0	2.0	60.0	51.7	97	0.108
5KP64	5KP64C	71.1	96.9	5.0	2.0	64.0	43.9	114	0.108
5KP64A	5KP64CA	71.1	78.6	5.0	2.0	64.0	48.5	103	0.108
5KP70	5KP70C	77.6	95.1	5.0	2.0	70.0	40.0	125	0.108
5KP70A	5KP70CA	77.8	86.0	5.0	2.0	70.0	44.2	113	0.108
5KP75	5KP75C	83.3	102	5.0	2.0	75.0	37.3	134	0.108
5KP75A	5KP75CA	83.3	92.1	5.0	2.0	75.0	41.3	121	0.108

Electrical Characteristics ($T_A=25^\circ\text{C}$ unless otherwise noted)

Part Number(U ni)	Part Number(Bi)	Breakdown Voltage $V_{BR}@I_T$			Maximum Reverse Leakage $I_R@V_{WM} (\mu A)$	Working Peak Reverse Voltage $V_{RWM}(V)$	Maximum Reverse Surge Current IPP (A)	Maximum Clamping Voltage $V_C@I_{FP}(V)$	Maximum Temperature Coefficient of $V_{BR} (\%/^\circ\text{C})$
		Min(V)	Max (V)	IT(mA)					
5KP78	5KP78C	86.7	106.0	5.0	2.0	78.0	36.0	139	0.108
5KP78A	5KP78CA	86.7	95.8	5.0	2.0	78.0	39.7	126	0.108
5KP85	5KP85C	94.4	115	5.0	2.0	85.0	33.1	151	0.108
5KP85A	5KP85CA	94.4	104	5.0	2.0	85.0	36.5	137	0.110
5KP90	5KP90C	100	122	5.0	2.0	90.0	31.3	160	0.110
5KP90A	5KP90CA	100	111	5.0	2.0	90.0	34.2	146	0.110
5KP100	5KP100C	111	136	5.0	2.0	100	27.9	179	0.110
5KP100A	5KP100CA	111	123	5.0	2.0	100	30.9	162	0.110
5KP110	5KP110C	122	149	5.0	2.0	110	25.5	196	0.112
5KP110A	5KP110CA	122	135	5.0	2.0	110	28.2	177	0.112
5KP120	5KP120C	133	163	5.0	2.0	120	23.4	214	0.112
5KP120A	5KP120CA	133	147	5.0	2.0	120	25.9	193	0.112
5KP130	5KP130C	144	176	5.0	2.0	130	21.6	230	0.112
5KP130A	5KP130CA	144	159	5.0	2.0	130	23.9	209	0.112
5KP150	5KP150C	167	204	5.0	2.0	150	18.7	268	0.112
5KP150A	5KP150CA	167	185	5.0	2.0	150	20.6	243	0.112
5KP160	5KP160C	178	218	5.0	2.0	160	17.4	287	0.112
5KP160A	5KP160CA	178	197	5.0	2.0	160	19.3	259	0.112
5KP170	5KP170C	189	231	5.0	2.0	170	16.4	304	0.112
5KP170A	5KP170CA	189	209	5.0	2.0	170	18.2	275	0.112
5KP188	5KP188C	209	255	5.0	2.0	188	14.5	344	0.112
5KP188A	5KP188CA	209	231	5.0	2.0	188	15.2	328	0.112

Typical Characteristics

FIG1: Peak Pulse Power Rating Curve

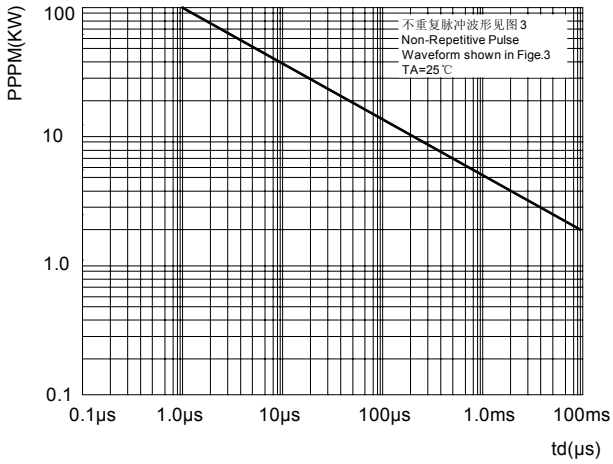

FIG2: Pulse Power or Current vs. Initial Junction Temperature

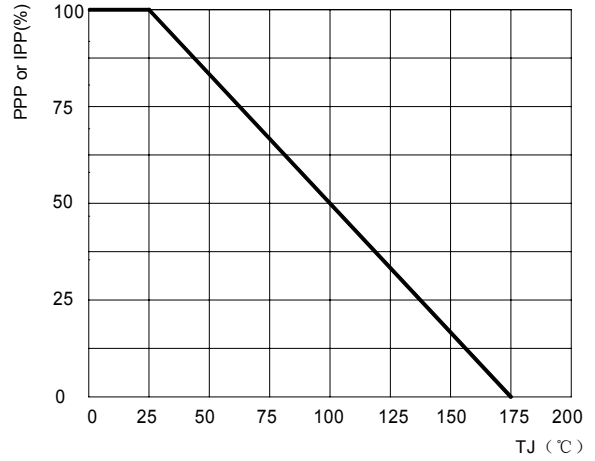

FIG3: Pulse Waveform

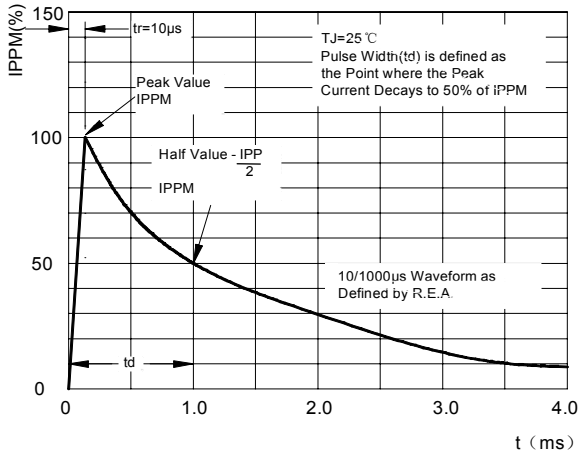

FIG4: Power Derating Curve

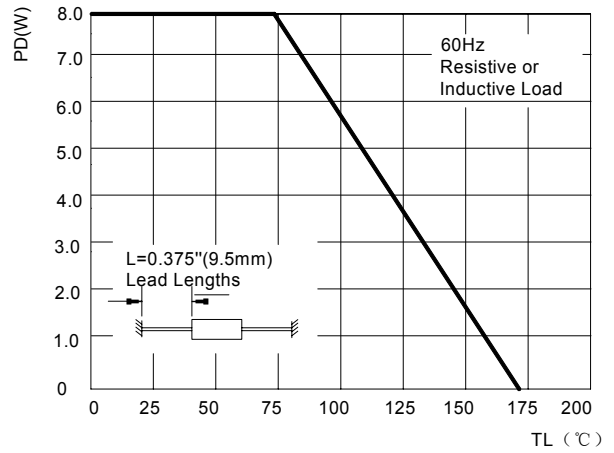
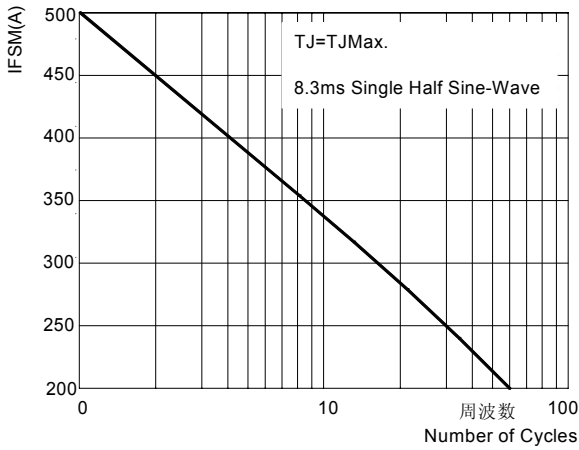
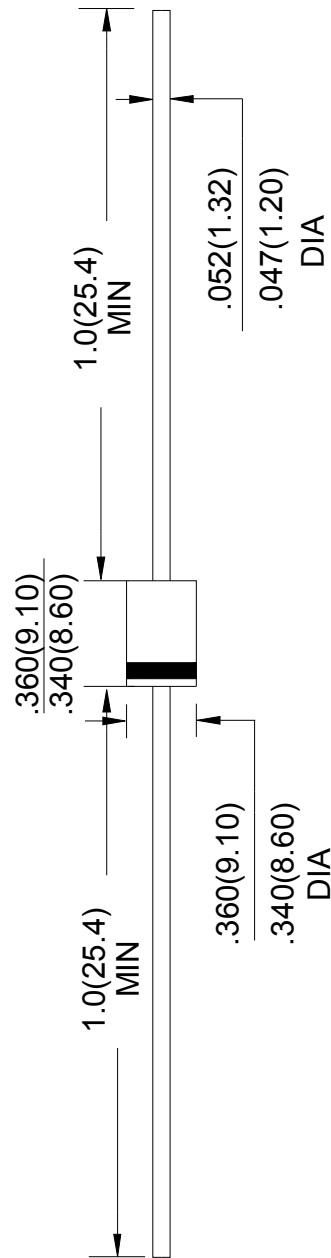

FIG5: Maximum Non-Repulsive Surge Current





Unit: in inches (millimeters)

NOTICE

JSCJ reserves the right to make modifications, enhancements, improvements, corrections or other changes without further notice to any product herein. JSCJ does not assume any liability arising out of the application or use of any product described herein.

Ammo Box Packaging Specifications For Axial Lead Rectifiers

Axial lead devices are packed in accordance with EIA standard RS-296-D and specifications given below

COMPONENT OUTLINE	COMPONENT PITCH A	INNER TAPE PITCH B	CUMULATIVE PITCH TOLERANCE
	$\pm 0.5\text{mm}(0.020'')$	$+0.5\text{mm}(0.020'')$	
R-1	5.0mm	26.0mm	2.0mm/20pitch
R-1	5.0mm	52.4mm	2.0mm/10pitch
A-405	5.0mm	26.0mm	2.0mm/20pitch
A-405	5.0mm	52.4mm	2.0mm/10pitch
DO-34/DO-35	5.0mm	26.0mm	2.0mm/20pitch
DO-34/DO-35	5.0mm	52.4mm	2.0mm/10pitch
DO-41	5.0mm	26.0mm	2.0mm/20pitch
DO-41	5.0mm	52.4mm	2.0mm/10pitch
DO-15	5.0mm	52.4mm	2.0mm/10pitch
DO-27	10.0mm	52.4mm	2.0mm/10pitch
R-6	10.0mm	52.4mm	2.0mm/10pitch

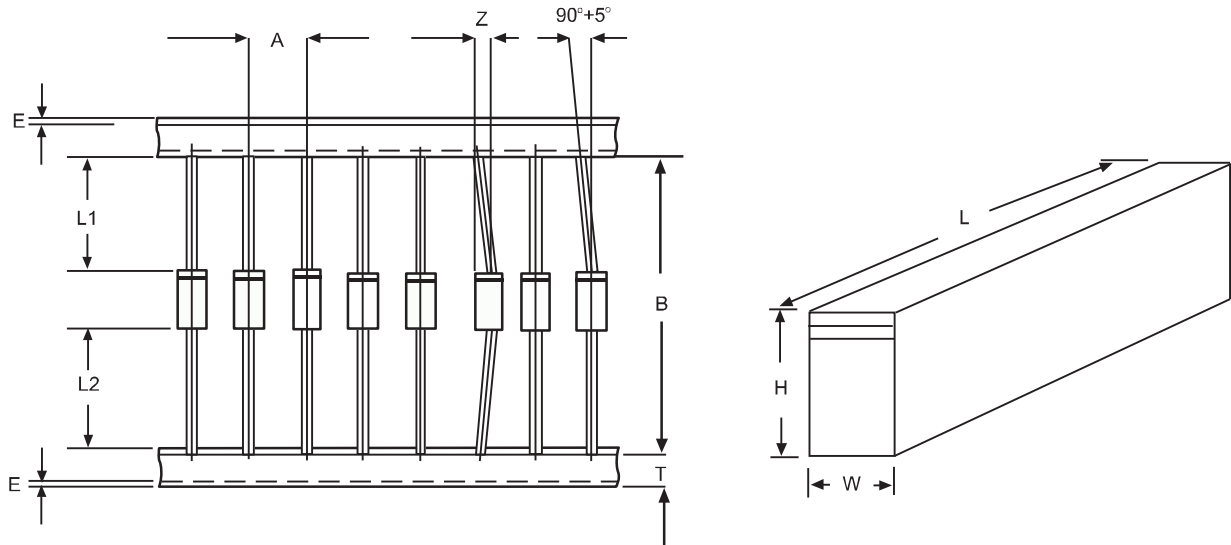

ITEM	SYMBOL	SPECIFICATIONS(mm)	SPECIFICATIONS(inch)
Component alignment	Z	1.2max	0.048max
Tape width	T	6.0 ± 0.4	0.236 ± 0.016
Exposed adhesive	E	0.8max	0.032max
Body eccentricity	$ L1-L2 $	1.0max	0.040max
Box length	L	255.0 ± 5.0	10.04 ± 0.197
Box width	W	78.0 ± 5.0	3.07 ± 0.197
Box height	H	150.0 ± 5.0	5.91 ± 0.197

NOTE: Each component lead shall be sandwiched between tapes for A minimum of 3.2mm(0.126'')