

## R-6 Plastic-Encapsulate Diodes

### 6KP SERIES Transient Voltage Suppressor Diodes

#### Features

- $P_{PP}$  6000W
- $V_{RWM}$  5V- 440V
- Glass passivated chip

#### Applications

- Clamping Voltage

#### Marking

- 6KP XXA/CA

XX : From 5.0 To 440

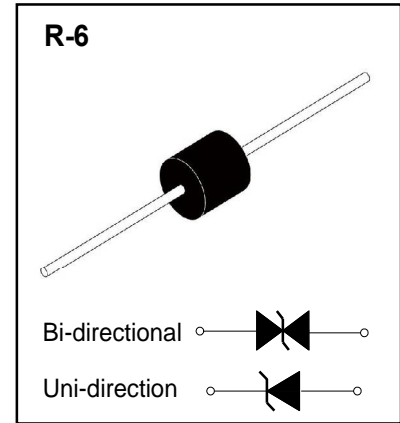

#### Limiting Values (Absolute Maximum Rating)

Item	Symbol	Unit	Conditions	Max
Peak pulse power dissipation	$P_{PPM}$	W	with a 10/1000us waveform	6000
Peak pulse current (1)	$I_{PPM}$	A	with a 10/1000us waveform	See Next Table
Power dissipation	$P_D$	W	On infinite heat sink at $T_L=75^\circ\text{C}$	8.0
Peak forward surge current(2)	$I_{FSM}$	A	8.3 ms single half sine-wave unidirectional only	500
Operation Junction and Storage Temperature Range	$T_J, T_{STG}$	$^\circ\text{C}$		-55 ~ +150

#### Electrical Characteristics ( $T_a=25^\circ\text{C}$ Unless otherwise specified)

Item	Symbol	Unit	Conditions	Max
Maximum instantaneous forward Voltage (3)	$V_F$	V	at 25A for unidirectional only	3.5/5.0

#### Notes:

(1)  $V_F < 3.5\text{V}$  for  $V_{BR} < 200\text{V}$  and  $V_F < 6.5\text{V}$  for  $V_{BR} > 201\text{V}$

## Electrical Characteristics (T<sub>A</sub>=25°C unless otherwise noted)

Part Number		Reverse Stand-Off Voltage	Breakdown Voltage @IT		Test Current	Maximum Clamping Voltage @IPP (V)	Maximum Peak Pulse Current	Maximum Reverse Leakage @VRWM
Uni	Bi	VRWM (V)	VBR MIN(V)	VBR MAX(V)	IT (mA)	VC(V)	IPP (A)	IR(μA)
6KP5.0A	6KP5.0CA	5	6.4	7	10	9.2	652.2	1000
6KP6.0A	6KP6.0CA	6	6.67	7.37	10	10.3	582.5	1000
6KP6.5A	6KP6.5CA	6.5	7.22	7.98	10	11.2	535.7	500
6KP7.0A	6KP7.0CA	7	7.78	8.6	10	12	500	500
6KP7.5A	6KP7.5CA	7.5	8.33	9.21	1	12.9	465.1	300
6KP8.0A	6KP8.0CA	8	8.89	9.83	1	13.6	441.2	300
6KP8.5A	6KP8.5CA	8.5	9.44	10.4	1	14.4	416.7	150
6KP9.0A	6KP9.0CA	9	10	11.1	1	15.4	389.6	50
6KP10A	6KP10CA	10	11.1	12.3	1	17	352.9	5
6KP11A	6KP11CA	11	12.2	13.5	1	18.2	329.7	5
6KP12A	6KP12CA	12	13.3	14.7	1	19.9	301.5	5
6KP13A	6KP13CA	13	14.4	15.9	1	21.5	279.1	5
6KP14A	6KP14CA	14	15.6	17.2	1	23.2	258.6	5
6KP15A	6KP15CA	15	16.7	18.5	1	24.4	245.9	5
6KP16A	6KP16CA	16	17.8	19.7	1	26	230.8	5
6KP17A	6KP17CA	17	18.9	20.9	1	27.6	217.4	5
6KP18A	6KP18CA	18	20	22.1	1	29.2	205.5	5
6KP19A	6KP19CA	19	21.1	23.3	1	30.8	194.8	5
6KP20A	6KP20CA	20	22.2	24.5	1	32.4	185.2	5
6KP22A	6KP22CA	22	24.4	26.9	1	35.5	169.0	5
6KP24A	6KP24CA	24	26.7	29.5	1	38.9	154.2	5
6KP26A	6KP26CA	26	28.9	31.9	1	42.1	142.5	5
6KP28A	6KP28CA	28	31.1	34.4	1	45.4	132.2	5
6KP30A	6KP30CA	30	33.3	36.8	1	48.4	124.0	5
6KP33A	6KP33CA	33	36.7	40.6	1	53.3	112.6	5
6KP36A	6KP36CA	36	40	44.2	1	58.1	103.3	5
6KP40A	6KP40CA	40	44.4	49.1	1	64.5	93.0	5
6KP43A	6KP43CA	43	47.8	52.8	1	69.4	86.5	5
6KP45A	6KP45CA	45	50	55.3	1	72.7	82.5	5
6KP48A	6KP48CA	48	53.3	58.9	1	77.4	77.5	5
6KP51A	6KP51CA	51	56.7	62.7	1	82.4	72.8	5
6KP54A	6KP54CA	54	60	66.3	1	87.1	68.9	5
6KP58A	6KP58CA	58	64.4	71.2	1	93.6	64.1	5
6KP60A	6KP60CA	60	66.7	73.7	1	96.8	62.0	5
6KP64A	6KP64CA	64	71.1	78.6	1	103	58.3	5
6KP70A	6KP70CA	70	77.8	86	1	113	53.1	5
6KP75A	6KP75CA	75	83.3	92.1	1	121	49.6	5
6KP78A	6KP78CA	78	86.7	95.8	1	126	47.6	5
6KP80A	6KP80CA	80	88.8	97.6	1	129.6	46.3	5
6KP85A	6KP85CA	85	94.4	104	1	137	43.8	5
6KP90A	6KP90CA	90	100	111	1	146	41.1	5
6KP100A	6KP100CA	100	111	123	1	162	37.0	5
6KP110A	6KP110CA	110	122	135	1	177	33.9	5
6KP120A	6KP120CA	120	133	147	1	193	31.1	5
6KP130A	6KP130CA	130	144	159	1	209	28.7	5
6KP140A	6KP140CA	140	155	171	1	226.8	26.5	5
6KP150A	6KP150CA	150	167	185	1	243	24.7	5
6KP160A	6KP160CA	160	178	197	1	259	23.2	5
6KP170A	6KP170CA	170	189	209	1	275	21.8	5
6KP180A	6KP180CA	180	201	220	1	291.6	20.6	5

## Electrical Characteristics ( $T_A=25^{\circ}\text{C}$ unless otherwise noted)

Part Number		Reverse Stand-Off Voltage	Breakdown Voltage @IT		Test Current	Maximum Clamping Voltage @IPP (V)	Maximum Peak Pulse Current	Maximum Reverse Leakage @VRWM
Uni	Bi	VRWM (V)	VBR MIN(V)	VBR MAX(V)	IT (mA)	VC(V)	IPP (A)	IR( $\mu\text{A}$ )
6KP190A	6KP190CA	190	211	232	1	307.8	19.5	5
6KP200A	6KP200CA	200	224	247	5	324	15.43	5
6KP210A	6KP210CA	210	233	258	5	349.5	14.31	5
6KP220A	6KP220CA	220	246	272	5	356	14.04	5
6KP250A	6KP250CA	250	279	309	5	405	12.35	5
6KP300A	6KP300CA	300	335	371	5	486	10.29	5
6KP350A	6KP350CA	350	391	432	5	567	8.82	5
6KP400A	6KP400CA	400	447	494	5	648	7.72	5
6KP440A	6KP440CA	440	492	543	5	713	7.01	5

# Typical Characteristics

FIG1: Peak Pulse Power Rating Curve

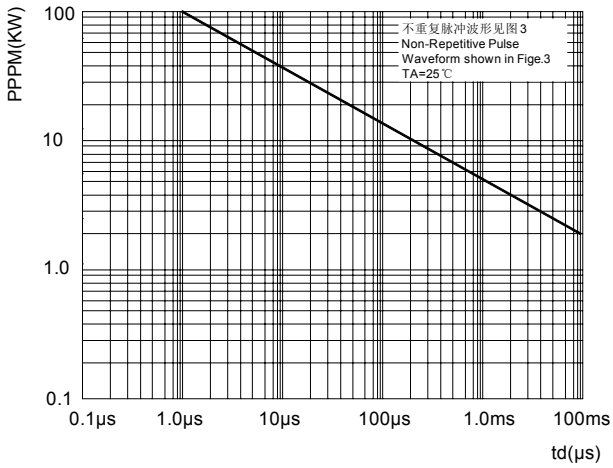

FIG2: Pulse Power or Current vs. Initial Junction Temperature

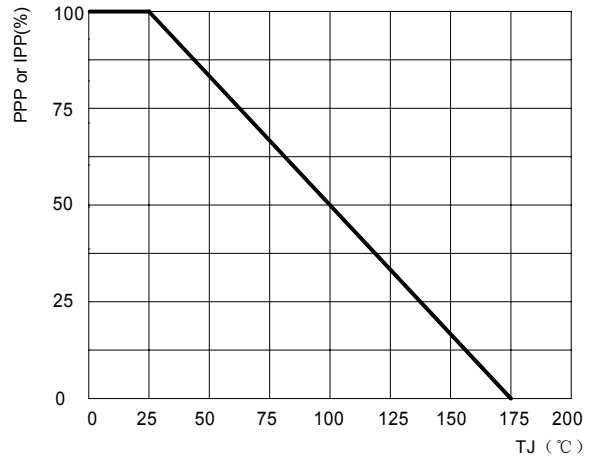

FIG3: Pulse Waveform

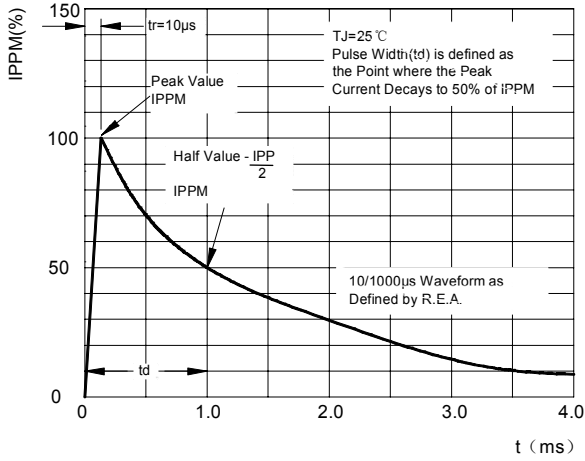

FIG4: Power Derating Curve

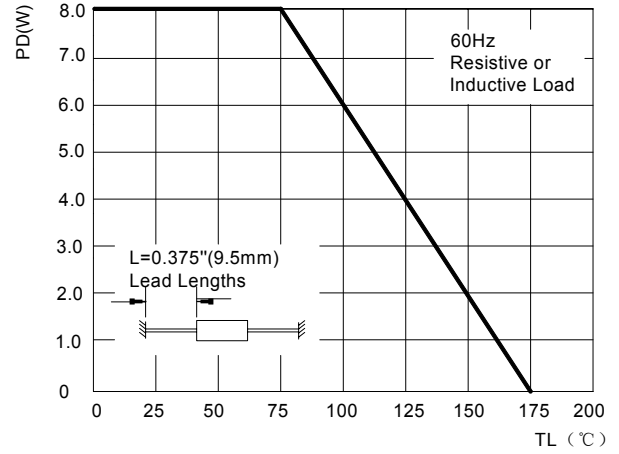
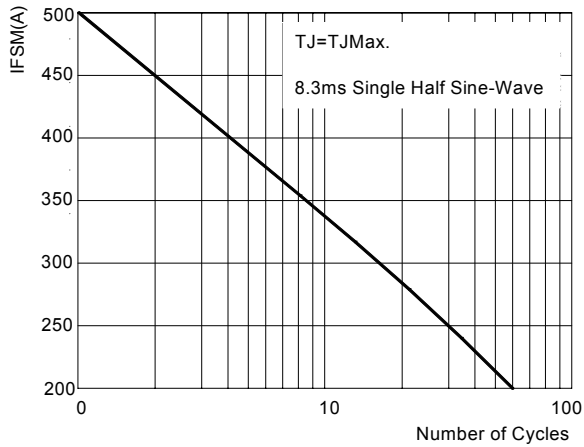
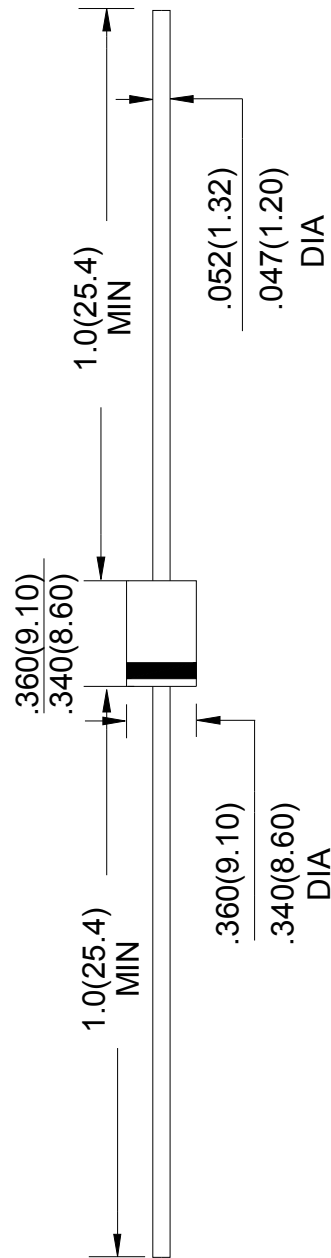

FIG5: Maximum Non-Repetitive Surge Current





Unit: in inches (millimeters)

NOTICE

JSCJ reserves the right to make modifications, enhancements, improvements, corrections or other changes without further notice to any product herein. JSCJ does not assume any liability arising out of the application or use of any product described herein.

# Ammo Box Packaging Specifications For Axial Lead Rectifiers

Axial lead devices are packed in accordance with EIA standard RS-296-D and specifications given below

COMPONENT OUTLINE	COMPONENT PITCH A	INNER TAPE PITCH B	CUMULATIVE PITCH TOLERANCE
	$\pm 0.5\text{mm}(0.020\text{'})$	$+0.5\text{mm}(0.020\text{'})$	
R-1	5.0mm	26.0mm	2.0mm/20pitch
R-1	5.0mm	52.4mm	2.0mm/10pitch
A-405	5.0mm	26.0mm	2.0mm/20pitch
A-405	5.0mm	52.4mm	2.0mm/10pitch
DO-34/DO-35	5.0mm	26.0mm	2.0mm/20pitch
DO-34/DO-35	5.0mm	52.4mm	2.0mm/10pitch
DO-41	5.0mm	26.0mm	2.0mm/20pitch
DO-41	5.0mm	52.4mm	2.0mm/10pitch
DO-15	5.0mm	52.4mm	2.0mm/10pitch
DO-27	10.0mm	52.4mm	2.0mm/10pitch
R-6	10.0mm	52.4mm	2.0mm/10pitch

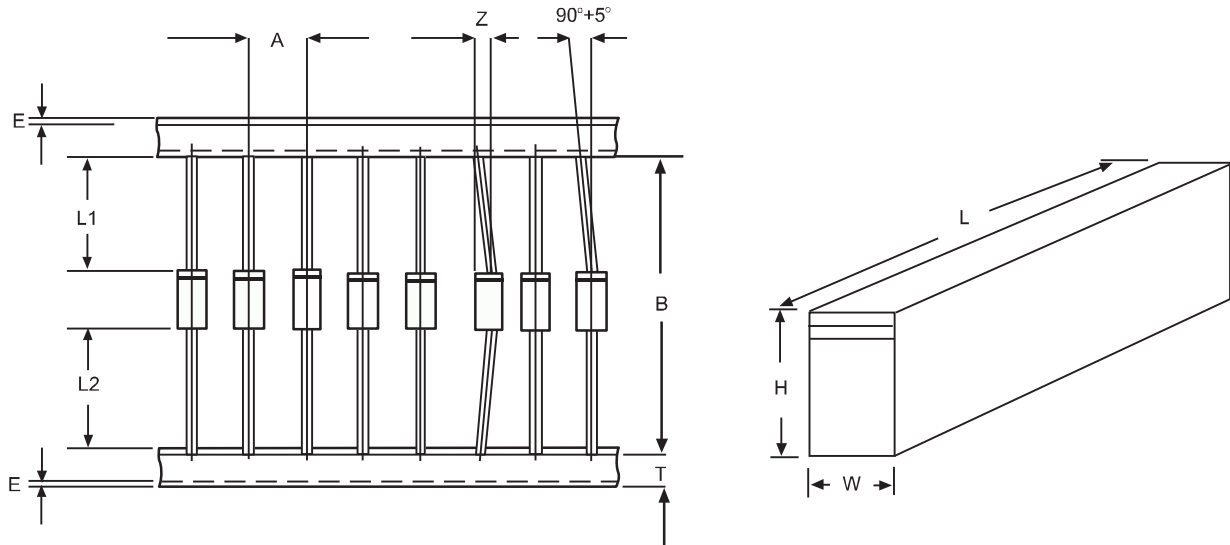

ITEM	SYMBOL	SPECIFICATIONS(mm)	SPECIFICATIONS(inch)
Component alignment	Z	1.2max	0.048max
Tape width	T	$6.0\pm 0.4$	$0.236\pm 0.016$
Exposed adhesive	E	0.8max	0.032max
Body eccentricity	$ L1-L2 $	1.0max	0.040max
Box length	L	$255.0\pm 5.0$	$10.04\pm 0.197$
Box width	W	$78.0\pm 5.0$	$3.07\pm 0.197$
Box height	H	$150.0\pm 5.0$	$5.91\pm 0.197$

NOTE: Each component lead shall be sandwiched between tapes for A minimum of 3.2mm(0.126'')