

SOT-363 Plastic-Encapsulate Diodes

BAV199DW Multi-Chip Diode

SOT-363

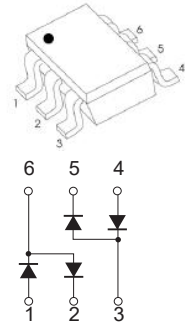

FEATURES

- Surface Mount Package Ideally Suited for Automatic Insertion
- Very Low Leakage Current

MARKING:K52

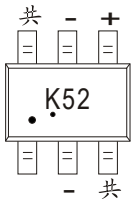

Solid dot = Pin1 indicate.

Solid dot = Green molding compound device.

Maximum Ratings and Electrical Characteristics, Single Diode @Ta=25 °C

Symbol	Parameter	Value	Unit
V_{RRM}	Peak Repetitive Reverse Voltage	85	V
V_{RWM}	Working Peak Reverse Voltage		
V_R	DC Reverse Voltage	85	V
I_O	Average Rectified Output Current	160	mA
I_{FSM}	Non-Repetitive Peak Forward Surge Current @t=8.3ms	1	A
P_D	Power Dissipation	200	mW
$R_{\theta JA}$	Thermal Resistance from Junction to Ambient	625	°C/W
T_J, T_{stg}	Operation Junction and Storage Temperature Range	-55~+150	°C

ELECTRICAL CHARACTERISTICS (Ta=25°C unless otherwise specified)

Parameter	Symbol	Test conditions	Min	Typ	Max	Unit
Reverse breakdown voltage	$V_{(BR)}$	$I_R=100\mu A$	85			V
Reverse voltage leakage current	I_R	$V_R=75V$			5	nA
Forward voltage	V_F	$I_F=1mA$ $I_F=10mA$ $I_F=50mA$ $I_F=150mA$			0.9 1.0 1.1 1.25	V
Total capacitance	C_{tot}	$V_R=0V, f=1MHz$		2		pF
Reveres recovery time	t_{rr}	$I_F=I_R=10mA$ $I_{rr}=0.1I_R, R_L=100\Omega$			3	μs

Typical Characteristics

Forward Characteristics

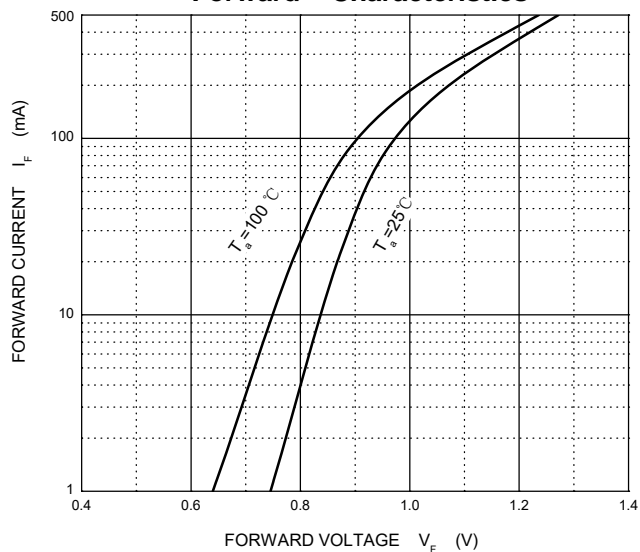

Reverse Characteristics

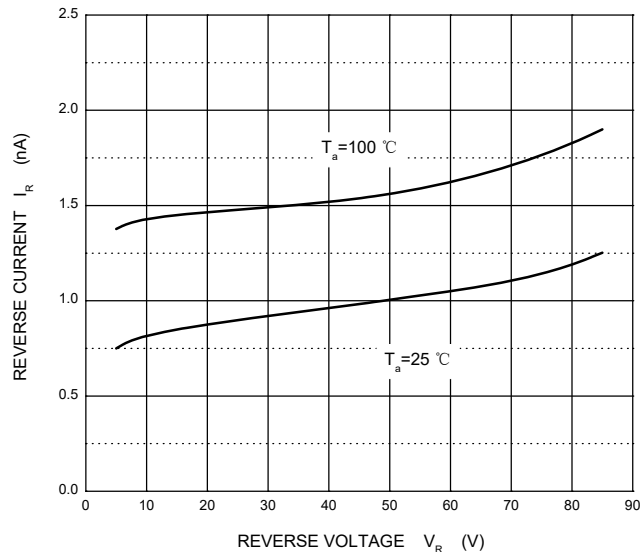

Capacitance Characteristics

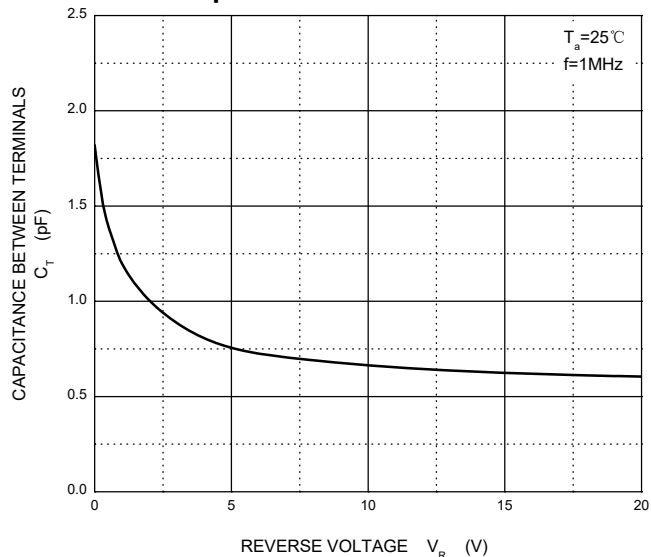

Power Derating Curve

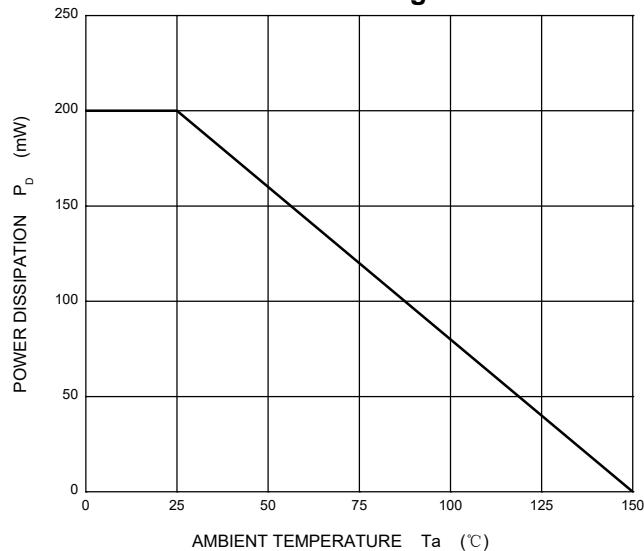

SOT-363 Package Outline Dimensions

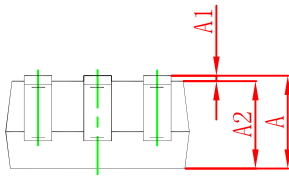
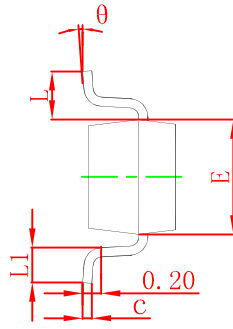
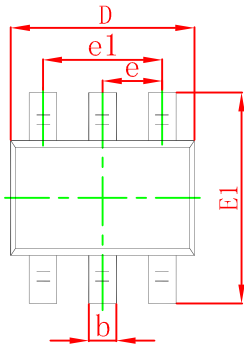

Symbol	Dimensions In Millimeters		Dimensions In Inches	
	Min	Max	Min	Max
A	0.900	1.100	0.035	0.043
A1	0.000	0.100	0.000	0.004
A2	0.900	1.000	0.035	0.039
b	0.150	0.350	0.006	0.014
c	0.100	0.150	0.004	0.006
D	2.000	2.200	0.079	0.087
E	1.150	1.350	0.045	0.053
E1	2.150	2.400	0.085	0.094
e	0.650 TYP		0.026 TYP	
e1	1.200	1.400	0.047	0.055
L	0.525 REF		0.021 REF	
L1	0.260	0.460	0.010	0.018
theta	0°	8°	0°	8°

SOT-363 Suggested Pad Layout

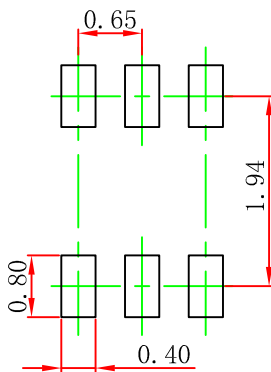

Note:

1. Controlling dimension: in millimeters.
2. General tolerance: $\pm 0.05\text{mm}$.
3. The pad layout is for reference purposes only.

NOTICE

JSCJ reserves the right to make modifications, enhancements, improvements, corrections or other changes without further notice to any product herein. JSCJ does not assume any liability arising out of the application or use of any product described herein.

SOT-363 Tape and Reel

SOT-363 Embossed Carrier Tape

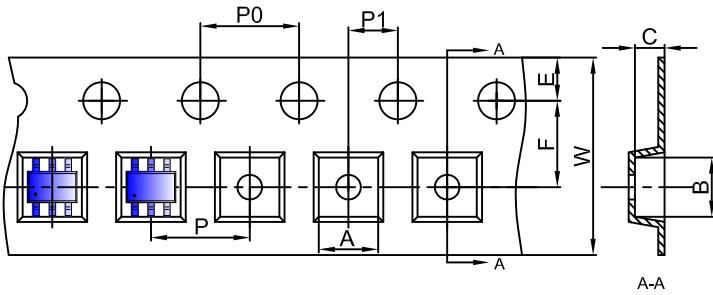

Packaging Description:

SOT-363 parts are shipped in tape. The carrier tape is made from a dissipative (carbon filled) polycarbonate resin. The cover tape is a multilayer film (Heat Activated Adhesive in nature) primarily composed of polyester film, adhesive layer, sealant, and anti-static sprayed agent. These reeled parts in standard option are shipped with 3,000 units per 7" or 17.8cm diameter reel. The reels are clear in color and is made of polystyrene plastic (anti-static coated).

Dimensions are in millimeter										
Pkg type	A	B	C	d	E	F	P0	P	P1	W
SOT-363	2.25	2.55	1.20	Ø1.50	1.75	3.50	4.00	4.00	2.00	8.00

SOT-363 Tape Leader and Trailer

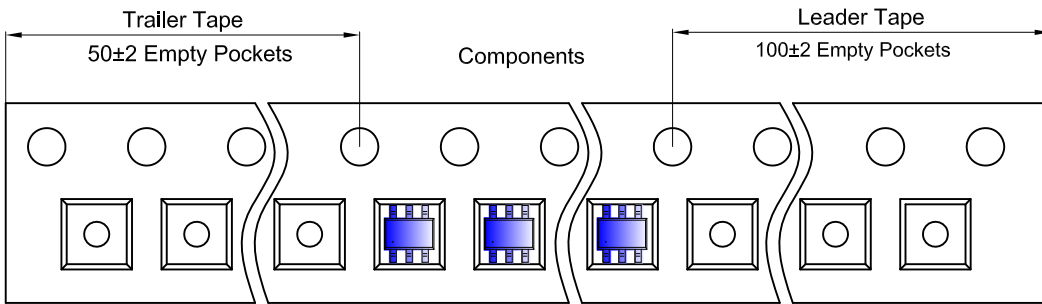

SOT-363 Reel

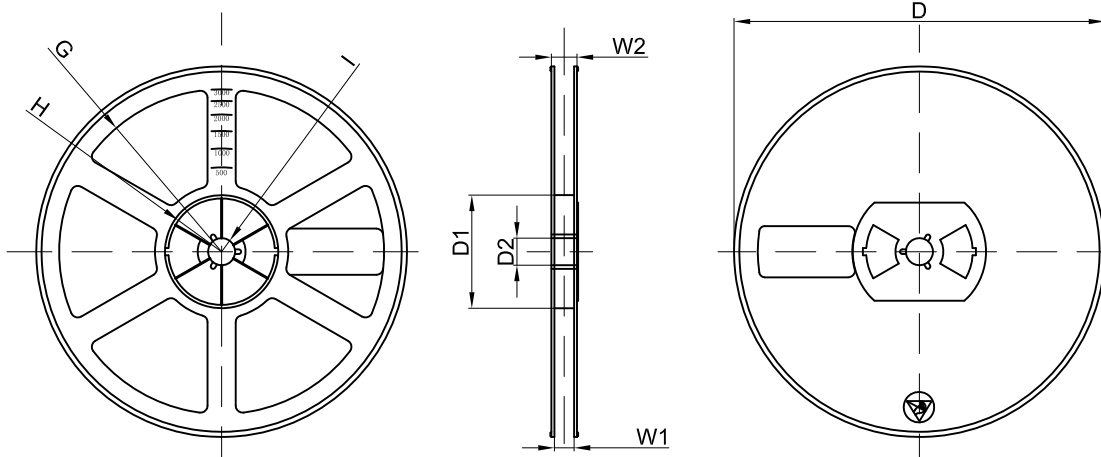

Dimensions are in millimeter								
Reel Option	D	D1	D2	G	H	I	W1	W2
7" Dia	Ø178.00	54.40	13.00	R78.00	R25.60	R6.50	9.50	12.30

REEL	Reel Size	Box	Box Size(mm)	Carton	Carton Size(mm)	G.W.(kg)
3000 pcs	7 inch	4' 000 pcs	20"×20"×19"	1' 0 000 pcs	4"8"×4"8"×220	