

CJ6108 Series Low-dropout Regulators

1 Introduction

The CJ6108 series is a group of low dropout voltage linear regulators manufactured using CMOS technology. It supports the input voltage range of 1.0V to 6.0V, and can also provide current up to 1A under the condition of good heat dissipation. The CJ6108 series has low quiescent current and low dropout voltage, and can provide large output current even when the input and output voltage difference is very small. In order to minimize costs and solution size, the CJ6108 series provides a fixed output voltage of 0.6V to 4.5V to support lower core voltages of modern microcontrollers (MCUs).

The CJ6108 series features an internal soft-start to lower the inrush current, which provides a controlled voltage to the load and minimizes the input voltage drop during start up. When shutdown, the device actively pulls down the output to quickly discharge the outputs and ensure a known start-up state.

In addition, the CJ6108 series also integrates output current limiting and thermal shutdown, which helps to protect devices in the event of load short circuits or faults.

2 Applications

- Battery-powered Equipment
- Camera Modules and Image Sensors
- Grid Infrastructure and Protection Relays
- Set-top Boxes, TV, Gaming Consoles
- Tablets and Remote Controls
- White Goods and Appliances

3 Features

- Input Voltage Range: 1.0V ~ 6.0V
- Fixed Output Voltage:
Available from 0.6V to 4.5V
- Output Voltage Tolerance:
±15mV for $V_{OUT} < 1.5V$
±1% for $V_{OUT} > 1.5V$
- Output Current: up to 1A
- Low Quiescent Current: 40µA (Typ.)
- Dropout Voltage:
310mV@1000mA ($V_{OUT} = 3.3V$)
- Power Supply Rejection Ratio:
75dB@1kHz
- Excellent Transient Response
- Integrated Fault Protection:
 - Inrush Current Limit
 - Output Current Limit
 - Thermal Shutdown
 - Short-Circuit Protection

4 Available Packages

PART NUMBER	PACKAGE
CJ6108 Series	SOT-89-3L
	SOT-223
	SOT-23-5L
	DFNWB1×1-4L
	DFNWB2×2-6L
	DFNWB1.2×1.2-4L

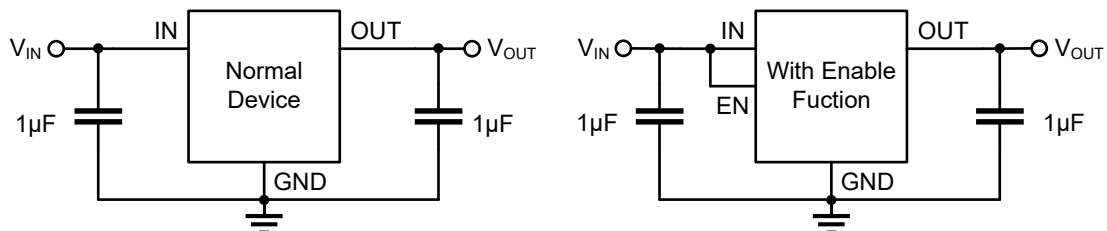

Typical Application Circuits

Please carefully read the notice at the end of this data sheet about product use, data sheet changes and important statements.

5 Pin Configuration and Marking Information

5.1 Pin Configuration

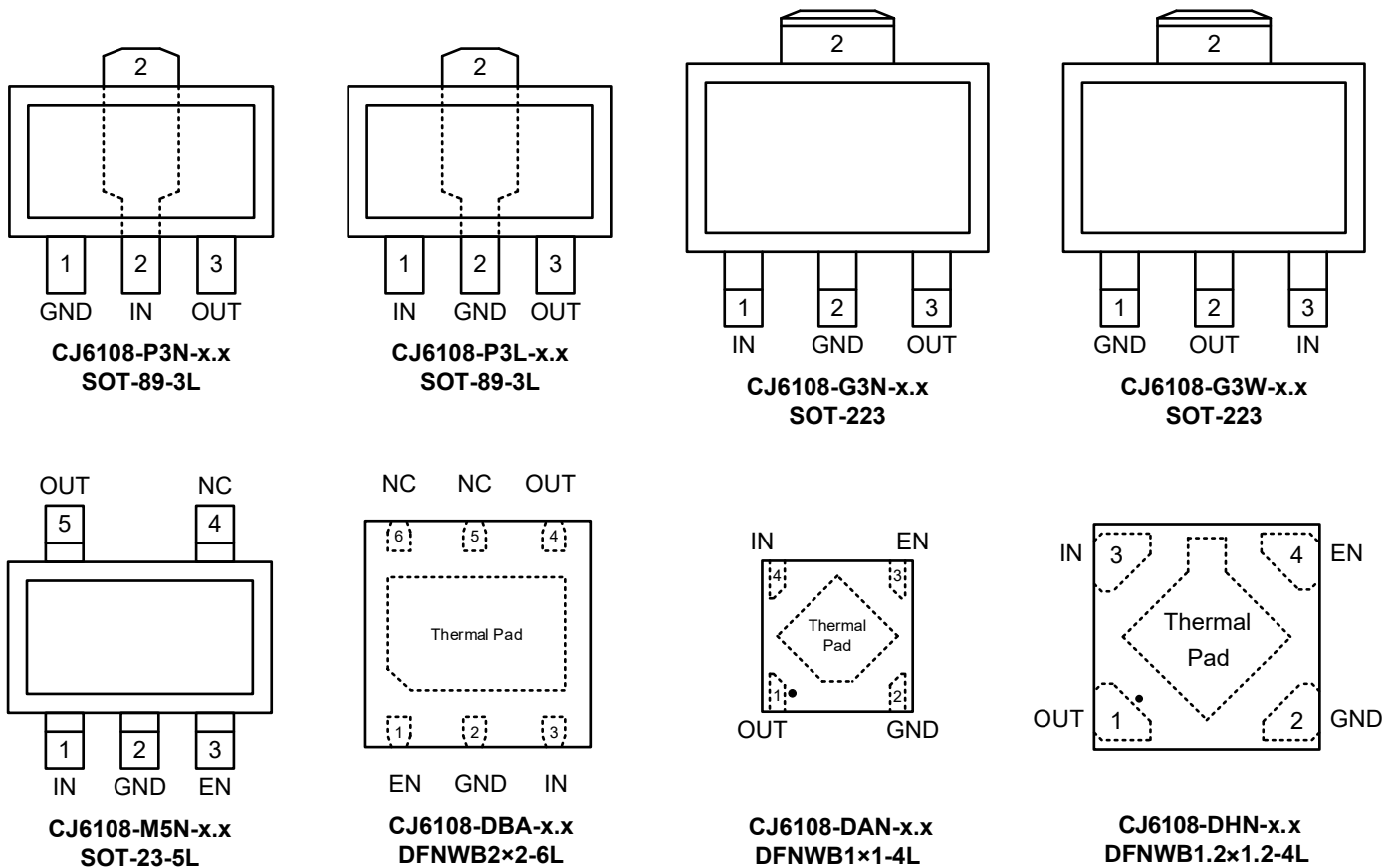

Figure 5-1. Package Top View (Not to Scale)

5.2 Pin Function

PIN NAME	I / O	CJ6108 Series Pin Function	
			DESCRIPTION
IN	I		Input to the device. Use the recommended value of the input capacitor and place it as close to the input of the device as possible to reduce the impedance of the input supply.
GND	-		Regulator ground.
EN	I		Enable pin. Driving this pin to logic high enables the device, driving this pin to logic low disables the device. The EN pin can be floating, and when the EN is floating, it will be pulled down to ground internally. If enable functionality is not required, it's recommended to connect EN to IN.
NC	-		No internal connection. This pin can float, but when this pin is connected to GND, the device has better thermal performance.
OUT	O		Output of the regulator. An output capacitor is required for stability and help device obtain the best transient response. Use the capacitor with the recommended value and place it as close as possible to the output.
Thermal Pad	-		Connect the thermal pad to a large-area ground plane. The thermal pad is internally connected to GND.

5 Pin Configuration and Marking Information

5.3 Marking Information

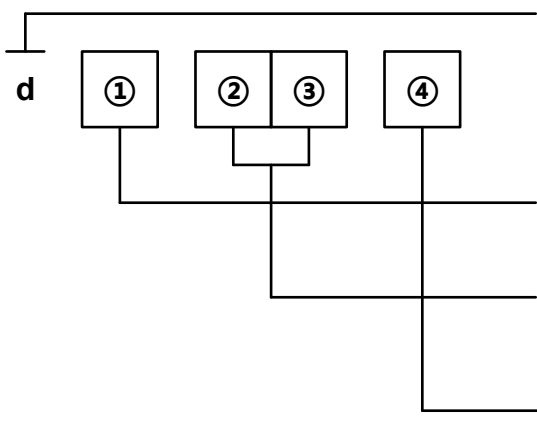
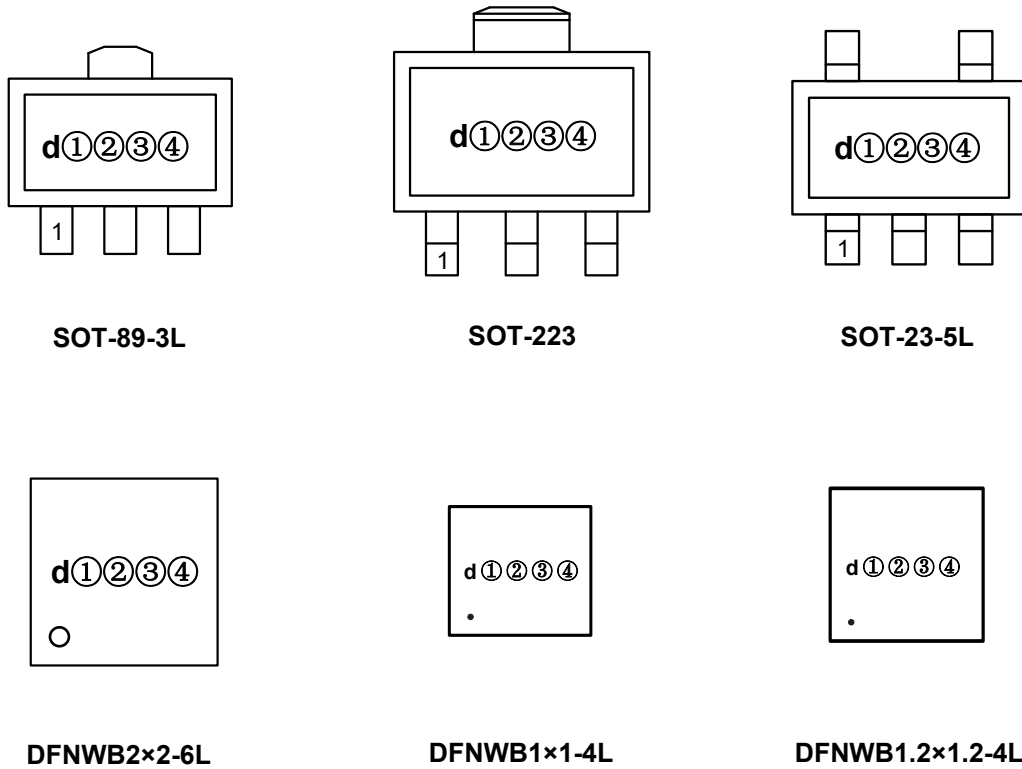

Serial code for CJ6108 series.

Representative output voltage.

- T: Fixed output 0.75V D: Fixed output 1.8V
- O: Fixed output 0.8V F: Fixed output 2.8V
- Q: Fixed output 1.1V G: Fixed output 3.0V
- B: Fixed output 1.2V H: Fixed output 3.3V
- X: Fixed output 1.3V

(Other products are customized)
Code, indicates weekly record information of production.

Code, special pin arrangement sequence.

- (blank): Normal
- L: P3L pin arrangement for SOT-89-3L
- W: G3W pin arrangement for SOT-223

Figure 5-2. Marking Rule

5 Pin Configuration and Marking Information
5.3 Marking Information (continued)

Output Voltage	Marking Information for CJ6108 Series				
	3-Pins Packages			4-Pins Packages	5-Pins Packages
	SOT-23-3L	SOT-89-3L	SOT-223	DFNWB1×1-4L	SOT-23-5L
1.05V	-	-	-	CJ6108-DAN-1.05: dQXX	-
1.1V	-	-	-	CJ6108-DAN-1.1: dQXX	-
1.2V	-	-	-	CJ6108-DAN-1.2: dBXX	-
1.3V	CJ6108-M3N-1.3: dXXX	-	-	-	-
1.8V	-	-	-	CJ6108-DAN-1.8: dDXX	CJ6108-M5N-1.8: dDXX
2.8V	-	-	-	CJ6108-DAN-2.8: dFXX	CJ6108-M5N-2.8: dFXX
3.0V	-	-	-	CJ6108-DAN-3.0: dGXX	-
3.3V	-	CJ6108-P3N-3.3: dHXX	CJ6108-G3N-3.3: dHXX	CJ6108-DAN-3.3: dHXX	CJ6108-M5N-3.3: dHXX
	-	-	CJ6108-G3W-3.3: dHXXW	-	-

6 Specifications

6.1 Absolute Maximum Ratings

($T_A = 25^\circ\text{C}$, unless otherwise specified)

CHARACTERISTIC		SYMBOL	VALUE	UNIT	
Input voltage range ⁽²⁾		V_{IN}	-0.3 ~ 7.0	V	
Enable input voltage range ⁽²⁾		V_{EN}	-0.3 ~ $V_{IN}+0.3$		
Output voltage range ⁽²⁾		V_{OUT}	-0.3 ~ $V_{IN}+0.3$		
Maximum power dissipation	CJ6108 Series	SOT-89-3L	$P_{D \text{ Max}}$	Internally Limited ⁽³⁾	W
		SOT-223			
		SOT-23-5L			
		DFNWB1×1-4L			
		DFNWB1.2×1.2-4L			
		DFNWB2×2-6L			
Maximum junction temperature		$T_{J \text{ Max}}$	150	°C	
Storage temperature		T_{stg}	-40 ~ 150	°C	
Soldering temperature & time		T_{solder}	260°C, 10s	-	

(1) Stresses beyond those listed under *Absolute Maximum Ratings* may cause permanent damage to the device. These are stress ratings only, which do not imply functional operation of the device at these or any other conditions beyond those indicated under *Recommended Operating Conditions*. Exposure to absolute-maximum rated conditions for extended periods may affect device reliability.

(2) All voltages are with respect to network ground terminal.

(3) Refer to *Thermal Information* for details.

6.2 Recommended Operating Conditions

PARAMETER	SYMBOL	MIN.	NOM.	MAX.	UNIT
Input voltage	V_{IN}	1.0	-	6.0	V
Operating junction temperature	T_J	-40	-	125	°C

6.3 ESD Ratings

ESD RATINGS		SYMBOL	VALUE	UNIT
Electrostatic discharge ⁽⁴⁾	Human body model	$V_{\text{ESD-HBM}}$	2000	V

(4) ESD testing is conducted in accordance with the relevant specifications formulated by the Joint Electronic Equipment Engineering Commission (JEDEC). The human body model (HBM) electrostatic discharge test is based on the JS-001: 2017 test standard, using a 100pF capacitor and discharging to each pin of the device through a resistance of 1.5kΩ.

6 Specifications

6.4 Thermal Information

THERMAL METRIC ⁽⁵⁾	SYMBOL	CJ6108 Series			UNIT
		SOT-89-3L	SOT-223	SOT-23-5L	
Junction-to-ambient thermal resistance	$R_{\theta JA}$	160.0	100.0	250.0	°C/W
		DFNWB1×1-4L	DFNWB1.2×1.2-4L	DFNWB2×2-6L	
		220.0	169.5	110.0	
Junction-to-case thermal resistance	$R_{\theta JC}$	52.5	18.0	65.0	°C/W
		DFNWB1×1-4L	DFNWB1.2×1.2-4L	DFNWB2×2-6L	
		115.0	53.8	34.5	
Reference maximum power dissipation for continuous operation	$P_{D Ref}$	0.63	1.00	0.42	W
		DFNWB1×1-4L	DFNWB1.2×1.2-4L	DFNWB2×2-6L	
		0.45	0.59	0.91	

(5) For SOT-89-3L, SOT-223 and SOT-23-5L packages, thermal metric is measured in still air with $T_A = 25^\circ\text{C}$ and installed on a 1 in² FR-4 board covered with 2 ounces of copper. For DFNWB2×2-6L package, thermal metric is measured in still air with $T_A = 25^\circ\text{C}$ and installed on a 1.5×1.5 in² FR-4 board covered with 1 ounces, 1 in² of copper.

6 Specifications

6.5 Electrical Characteristics

CJ6108 Series ($V_{IN} = V_{OUT} + 1V$, $C_{IN} = 1\mu F$, $C_{OUT} = 1\mu F$, $T_A = 25^\circ C$, unless otherwise specified)

CHARACTERISTIC	SYMBOL	TEST CONDITIONS	MIN.	TYP. ⁽⁶⁾	MAX.	UNIT	
Input voltage	V_{IN}	$T_A = 25^\circ C$	1.0	-	6.0	V	
DC output tolerance	-	$T_J = 25^\circ C$, $I_{OUT} = 10mA$	$V_{OUT} < 1.5V$	-15	-	15	mV
			$V_{OUT} > 1.5V$	-1	-	1	%
Output current	I_{OUT}	$T_J = 25^\circ C$	1000	-	-	mA	
Quiescent current	I_Q	$I_{OUT} = 0mA$	$V_{OUT} < 1.0V$	-	30	60	μA
			$V_{OUT} > 3.0V$	-	40	80	
Dropout voltage	$V_{DO}^{(7)}$	$V_{OUT} < 1.0V$	$I_{OUT} = 100mA$	-	250	-	mV
			$I_{OUT} = 500mA$	-	580	-	
		$V_{OUT} = 3.0$ to $3.6V$	$I_{OUT} = 100mA$	-	30	-	
			$I_{OUT} = 500mA$	-	150	-	
			$I_{OUT} = 1000mA$	-	310	-	
Line regulation	$LNR^{(8)}$	$V_{IN} = V_{OUT} + 1V$ to $6V$, $I_{OUT} = 10mA$	-	0.01	0.3	%/V	
Load regulation	ΔV_{LOAD}	$V_{IN} = V_{OUT} + 1V$, $I_{OUT} = 1$ to $100mA$	-	2	-	mV	
		$V_{IN} = V_{OUT} + 1V$, $I_{OUT} = 1$ to $1000mA$	-	25	-		
Temperature characteristics	$TR^{(9)}$	$I_{OUT} = 0mA$, $T_A = -40$ to $85^\circ C$	-	60	-	ppm/ $^\circ C$	
Output current limit	I_{Limit}	$V_{OUT} = 90\% \times V_{OUT Normal}$	1000	1200	-	mA	
Inrush current	I_{inrush}	$V_{IN} = V_{OUT} + 1V$, $V_{EN} = 0V \sim V_{IN}$	-	60	-	mA	
Power supply rejection ratio	$PSRR^{(10)}$	$I_{OUT} = 50mA$, $V_{OUT} = 3.3V$, $V_{IN} = (V_{OUT} + 1V)_{DC} + 0.25V_{PP AC}$	$f = 100Hz$	-	70	-	dB
			$f = 1kHz$	-	75	-	
			$f = 10kHz$	-	78	-	
			$f = 100kHz$	-	65	-	
Output noise voltage	$V_N^{(10)}$	$BW = 10$ to $100kHz$, $I_{OUT} = 300mA$	$V_{OUT} = 0.75V$	-	50	-	μV_{RMS}
			$V_{OUT} = 3.3V$	-	110	-	
EN high	$V_{EN H}$	-	1.0	-	V_{IN}	V	
EN low	$V_{EN Low}$	-	-	-	0.5	V	
EN pin current	I_{EN}	$V_{EN} = 5V$	-	0.05	0.5	μA	
Standby current	I_{STBY}	$EN = GND$	-	-	0.1	μA	
C_{OUT} auto-discharge resistance	$R_{Discharge}$	$V_{IN} = 5.0V$, $V_{OUT} = 3.0V$, $EN = GND$	-	200	-	Ω	
Thermal shutdown	T_{SD}	-	-	150	-	$^\circ C$	
Thermal shutdown hysteresis	ΔT_{SD}	-	-	20	-	$^\circ C$	
Load transient	$\Delta V_{OUT}^{(10)}$	$I_{OUT} = 1mA$ to $1000mA$ in $1\mu s$	-	80	-	mV	
		$I_{OUT} = 1000mA$ to $1mA$ in $1\mu s$	-	60	-		

6 Specifications

6.5 Electrical Characteristics (continued)

Note:

(6) Typical numbers are at 25°C and represent the most likely norm.

(7) Test the difference of output voltage and input voltage when input voltage is decreased gradually till output voltage equals to 98% of $V_{OUT\ Normal}$.

(8) The line regulation is calculated by the following formula:

$$LNR = \frac{\Delta V_{OUT}}{V_{OUT} \times \Delta V_{IN}}$$

where, ΔV_{OUT} is the variation of the output voltage, ΔV_{IN} is the variation of the input voltage.

(9) The output voltage temperature characteristics (TR) is calculated by the following formula:

$$TR = \frac{\Delta V_{OUT}}{V_{OUT} \times \Delta T}$$

where, ΔV_{OUT} is the variation of the output voltage, ΔT is the variation of the ambient temperature.

(10) Guaranteed by design, not subject to production testing.

6.6 Typical Characteristics

CJ6108 Series ($C_{IN} = 1\mu F$, $C_{OUT} = 1\mu F$, $T_A = 25^\circ C$, unless otherwise specified)

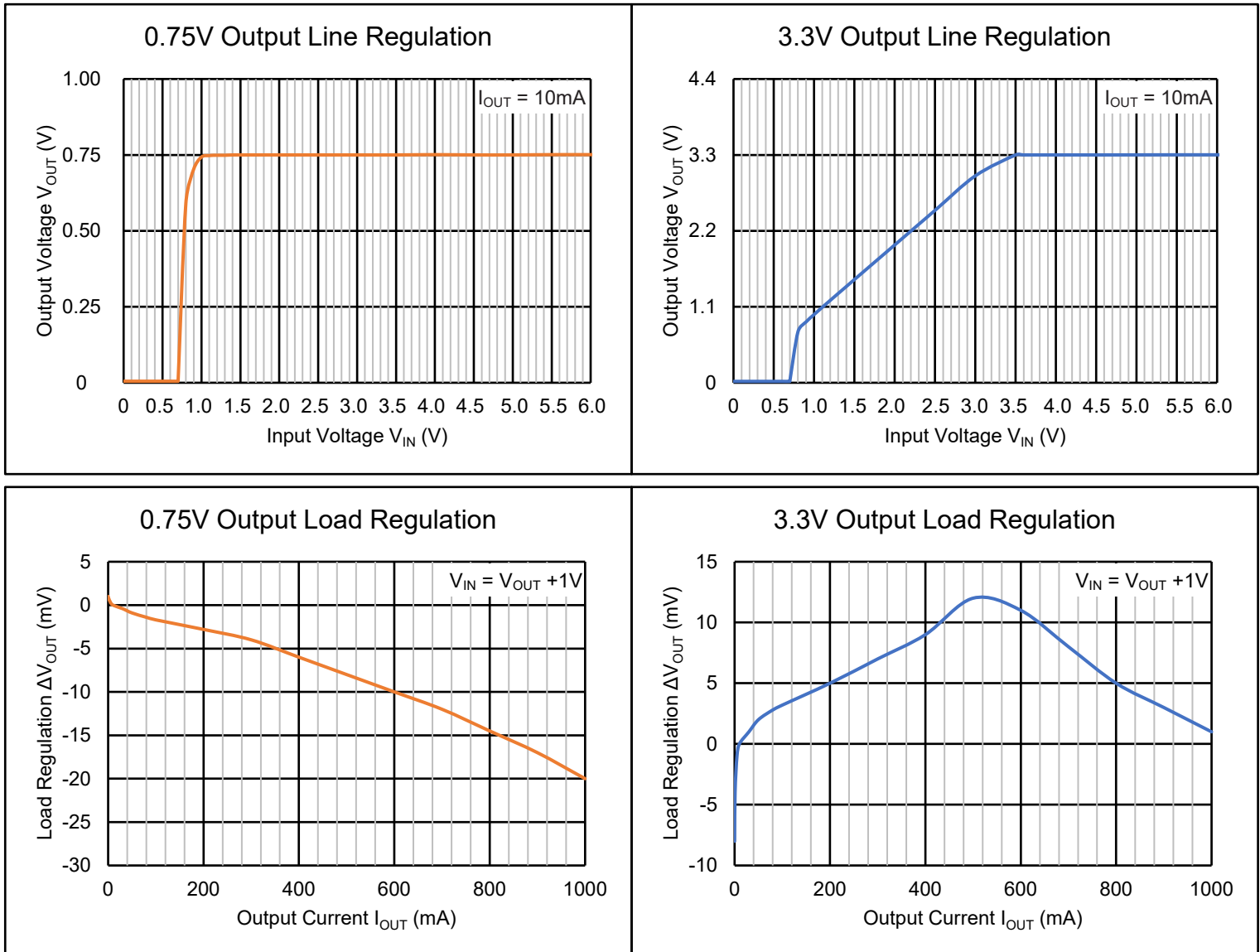

6 Specifications

6.6 Typical Characteristics (continued)

CJ6108 Series ($C_{IN} = 1\mu F$, $C_{OUT} = 1\mu F$, $T_A = 25^\circ C$, unless otherwise specified)

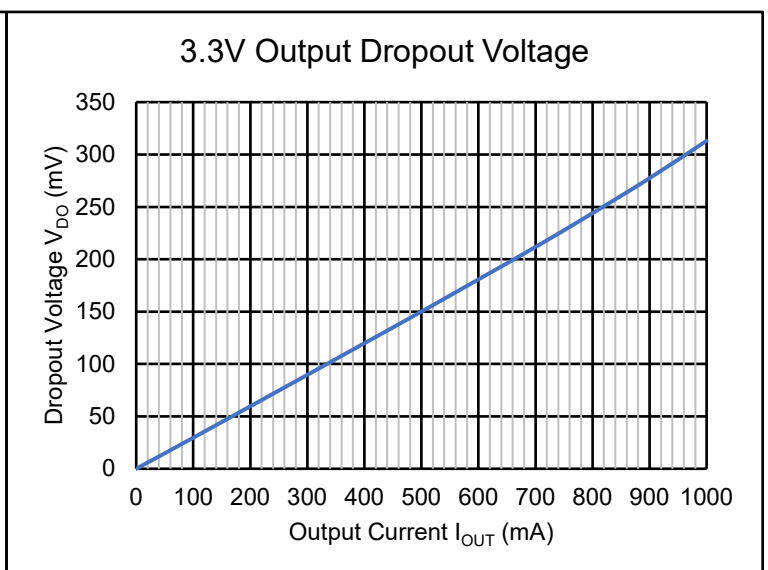
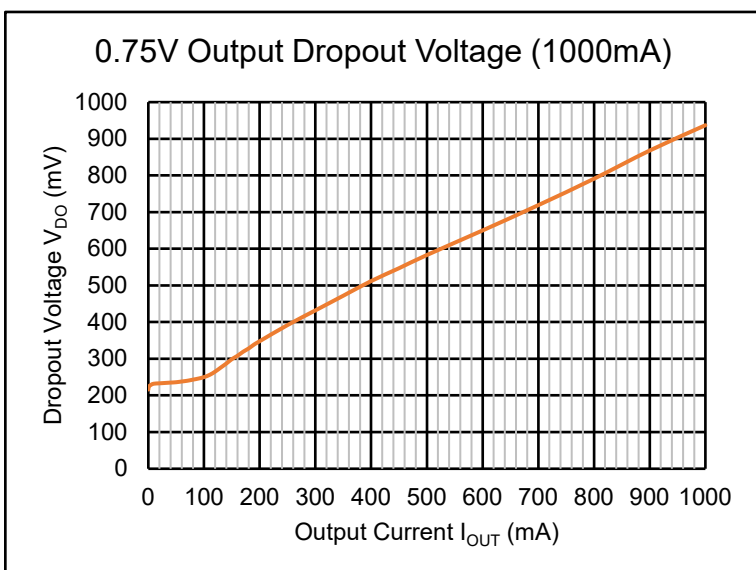
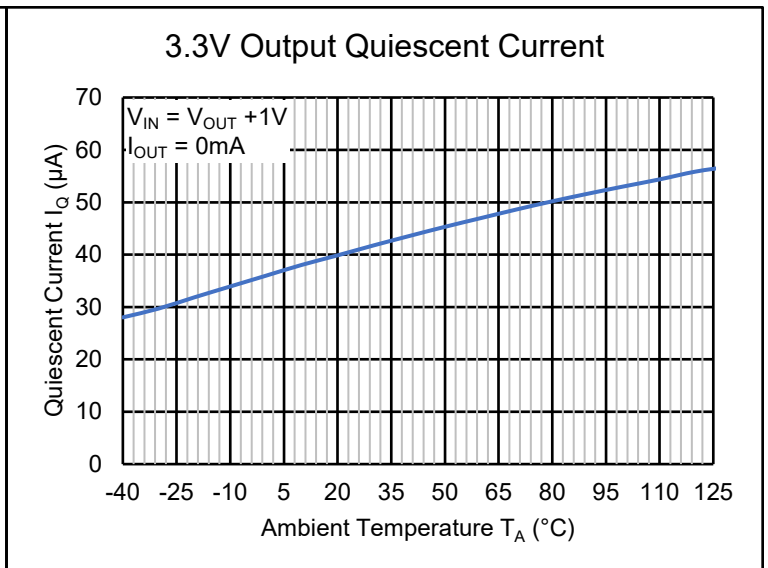
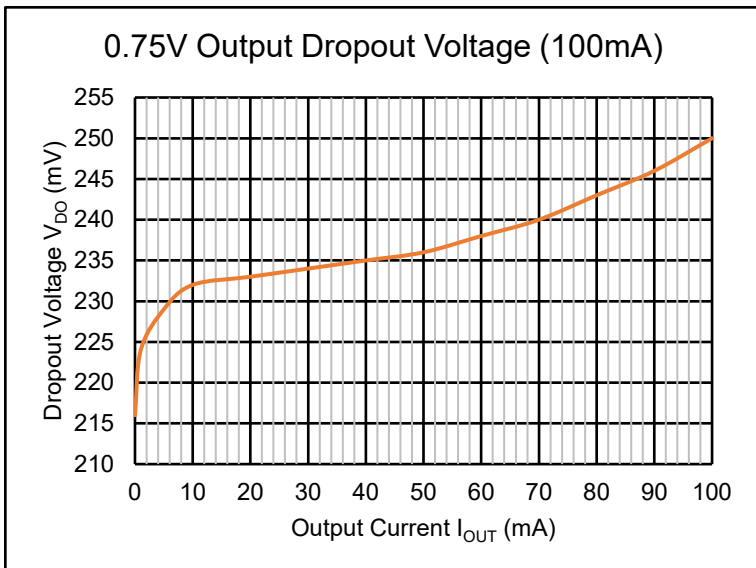
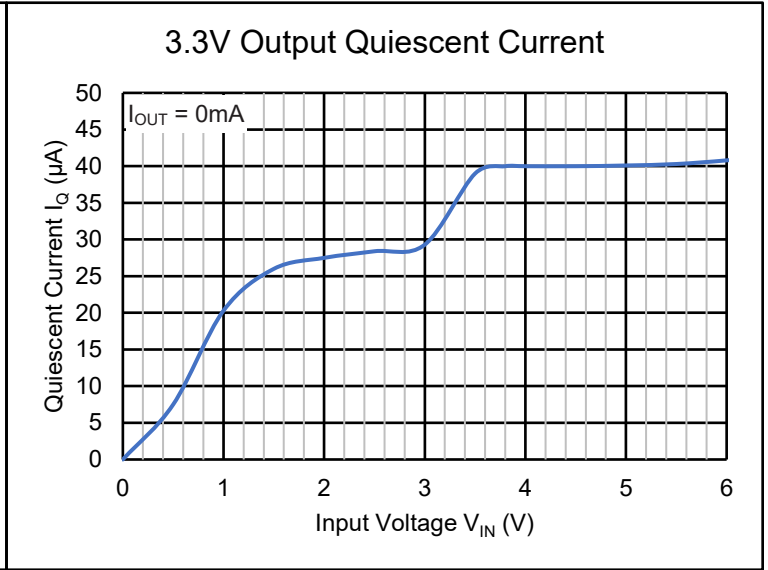
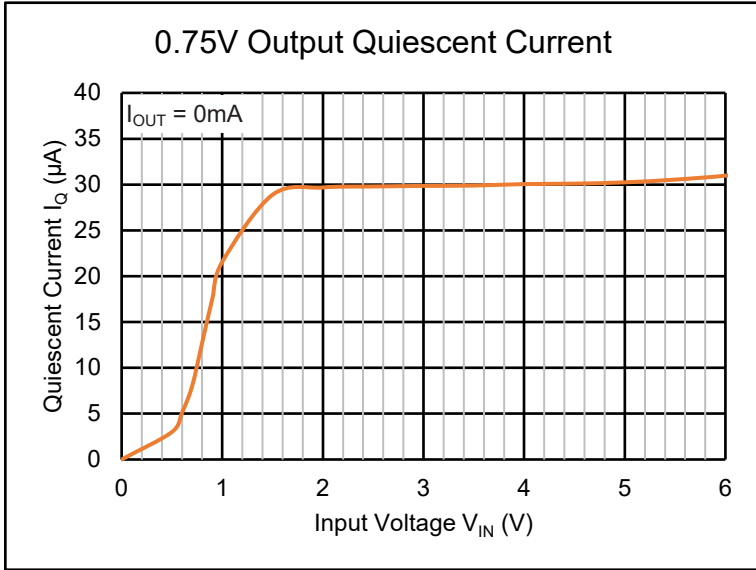

6 Specifications

6.6 Typical Characteristics (continued)

CJ6108 Series ($V_{IN} = V_{OUT} + 1V$, $C_{IN} = 1\mu F$, $C_{OUT} = 1\mu F$, $T_A = 25^\circ C$, unless otherwise specified)

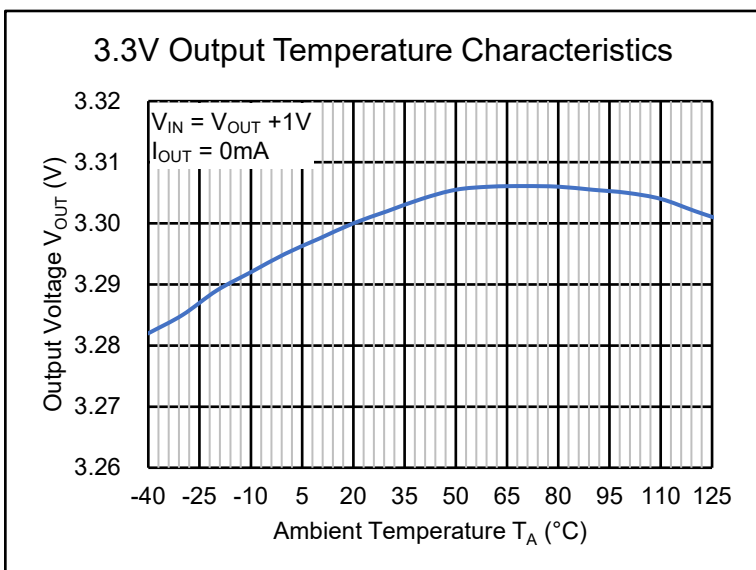
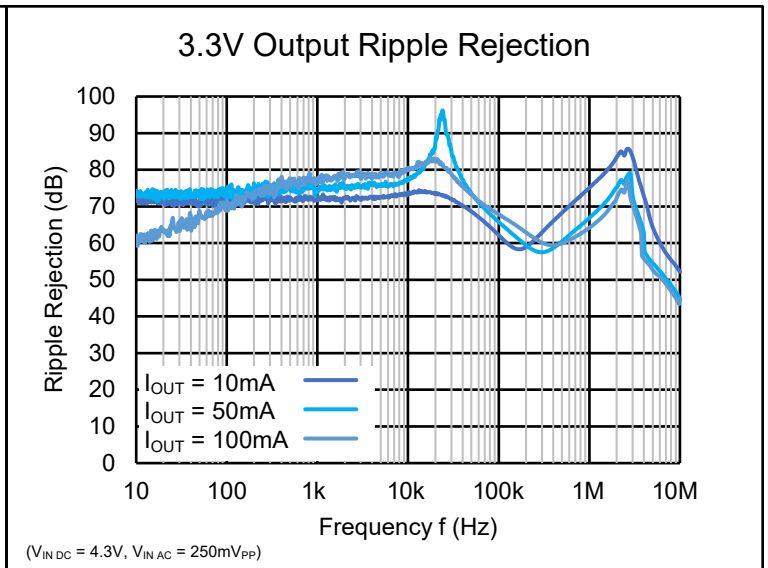
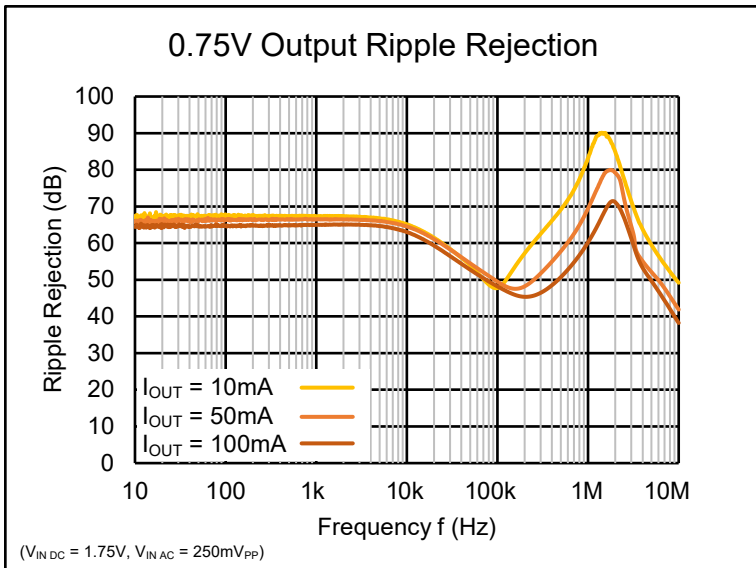
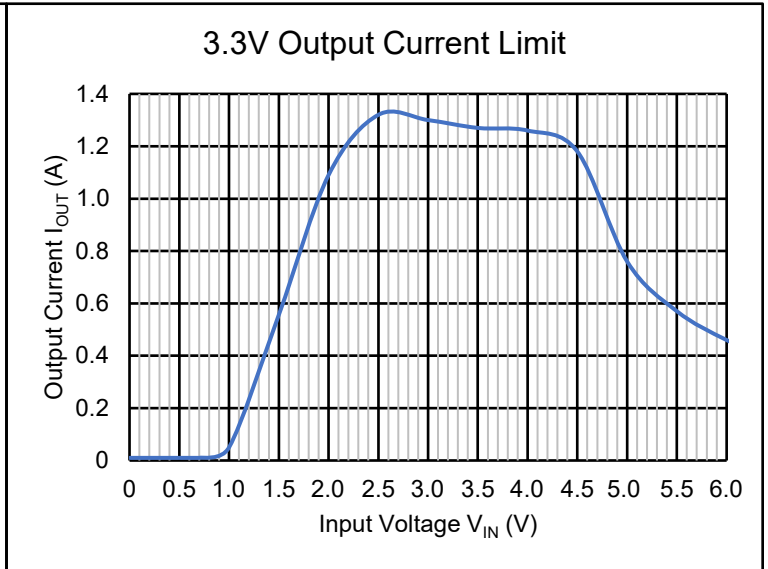
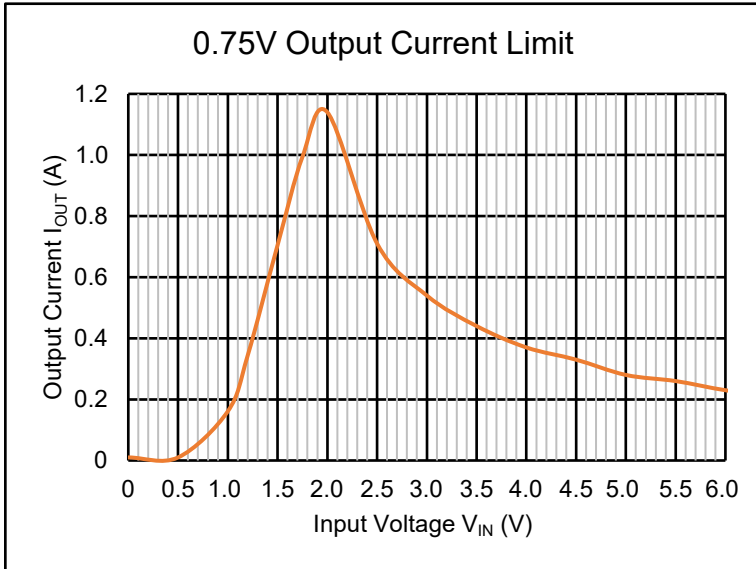

6 Specifications

6.6 Typical Characteristics (continued)

CJ6108 Series ($C_{IN} = 1\mu F$, $C_{OUT} = 1\mu F$, $T_A = 25^\circ C$, unless otherwise specified)

Load Transient ($V_{IN} = 1.8V$, $V_{OUT} = 0.75V$)

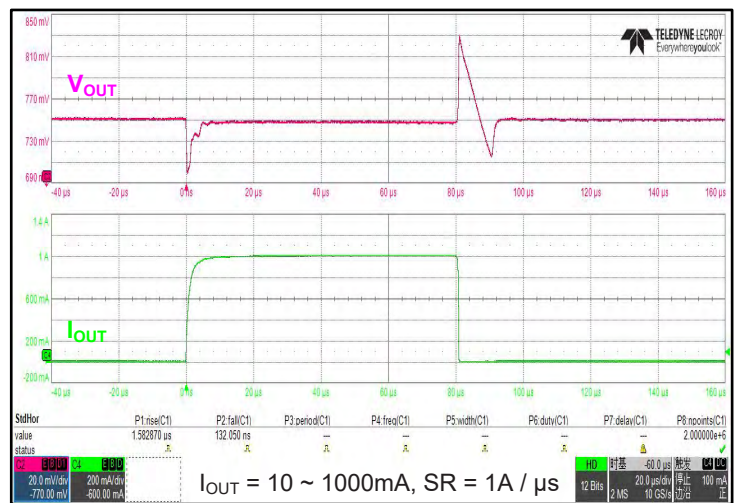
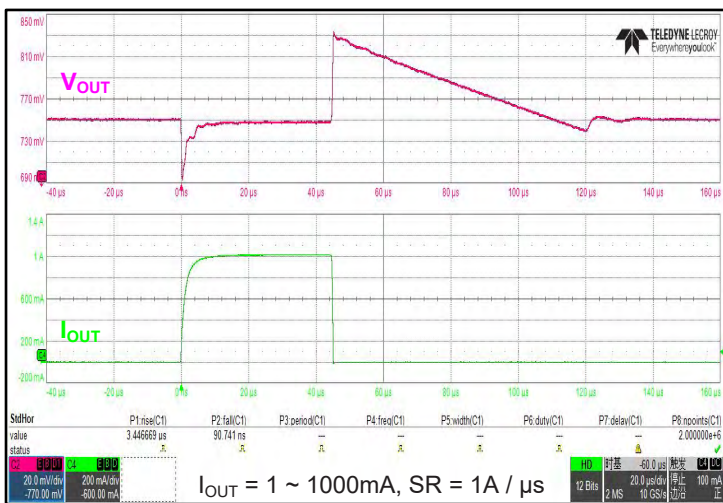
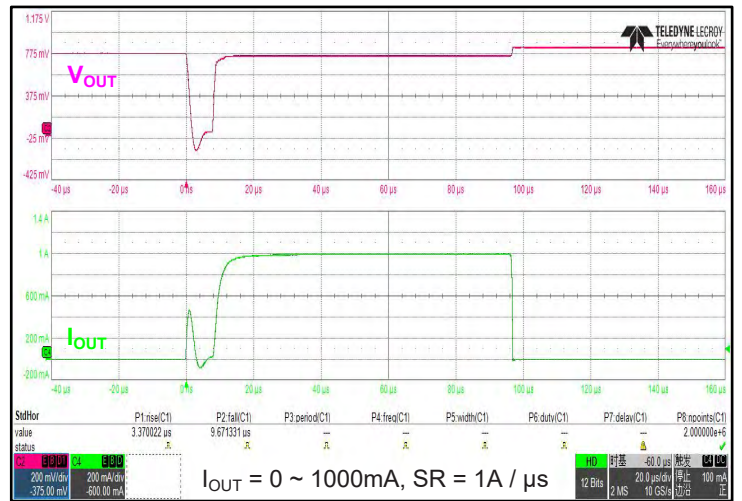
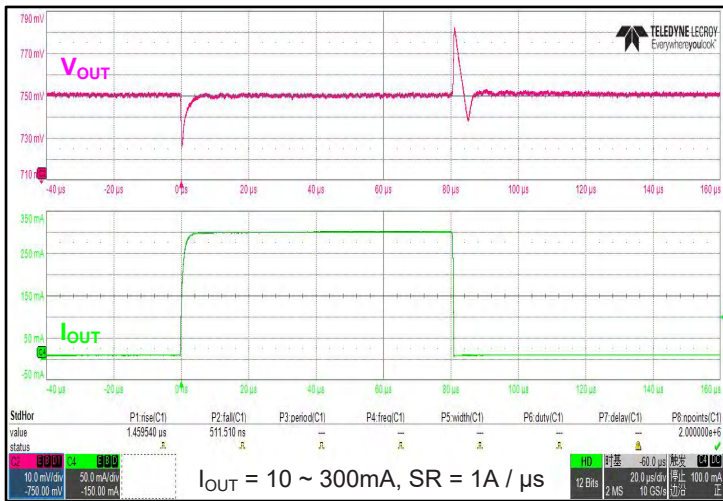
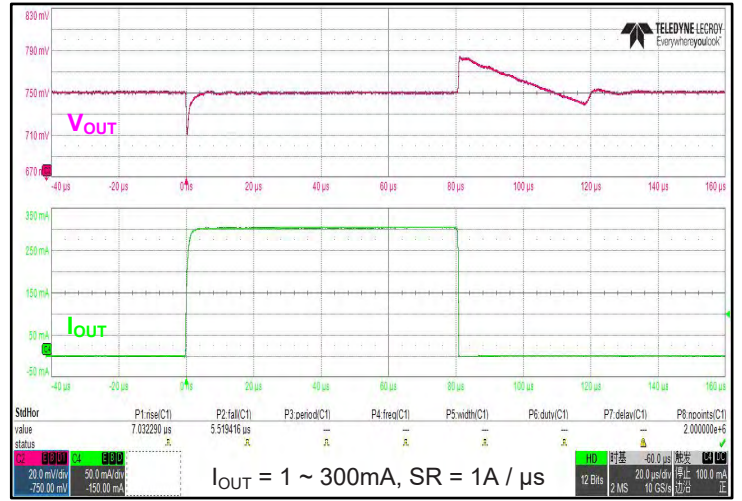
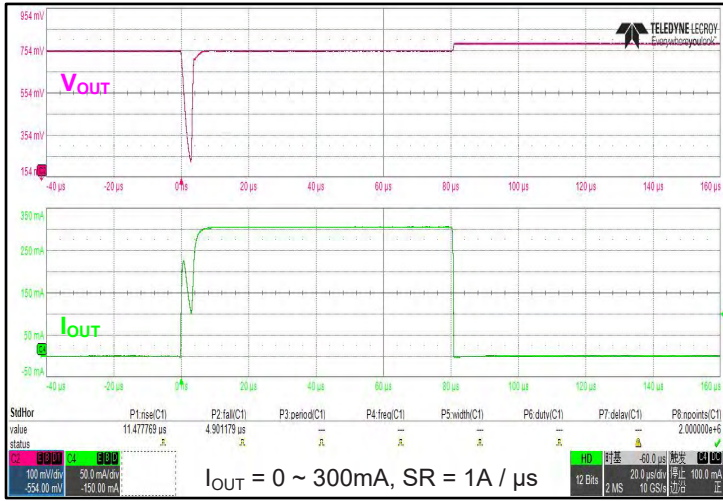

6 Specifications

6.6 Typical Characteristics (continued)

CJ6108 Series ($C_{IN} = 1\mu F$, $C_{OUT} = 1\mu F$, $T_A = 25^\circ C$, unless otherwise specified)

Load Transient ($V_{IN} = 4.3V$, $V_{OUT} = 3.3V$)

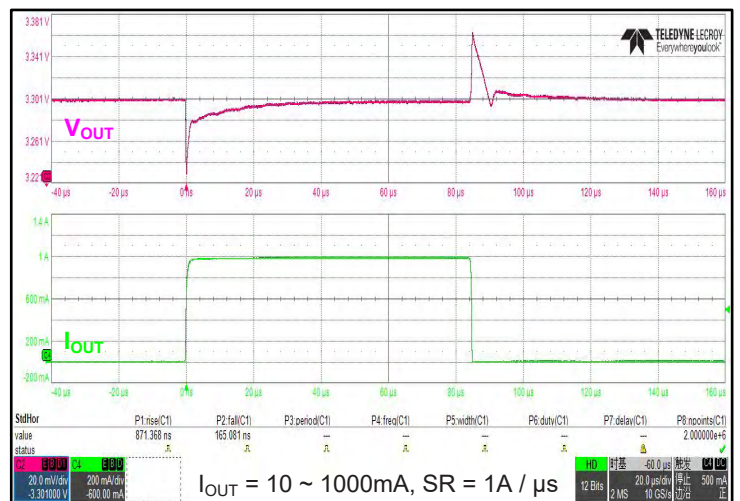
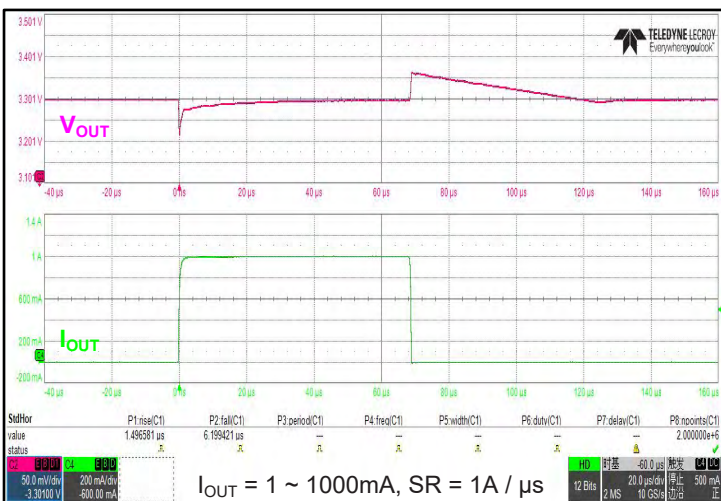
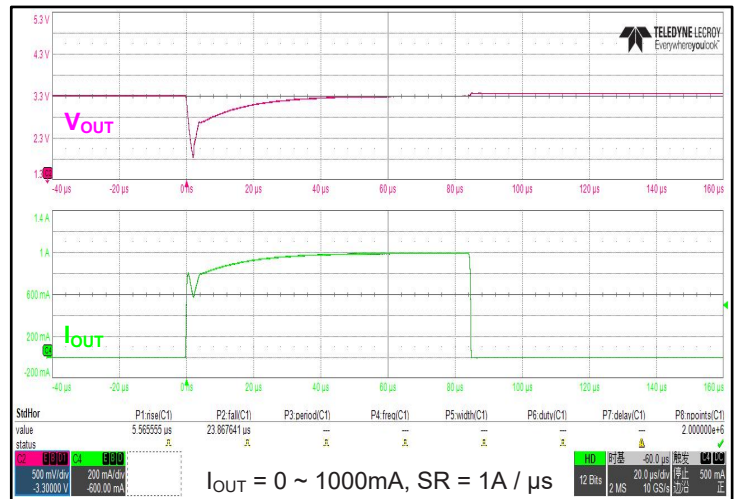
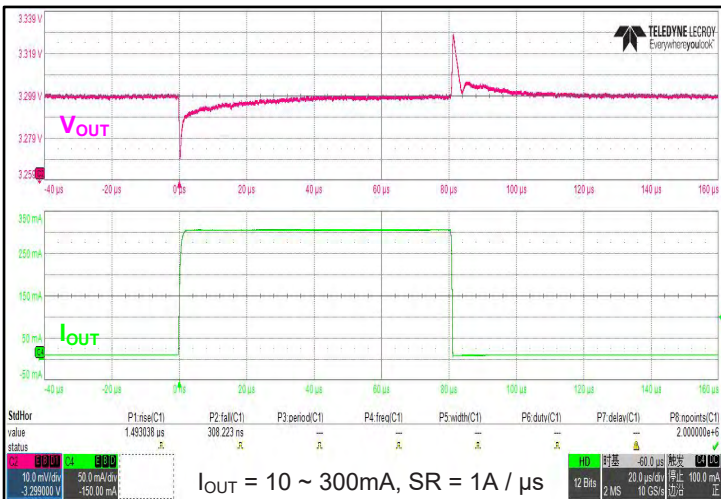
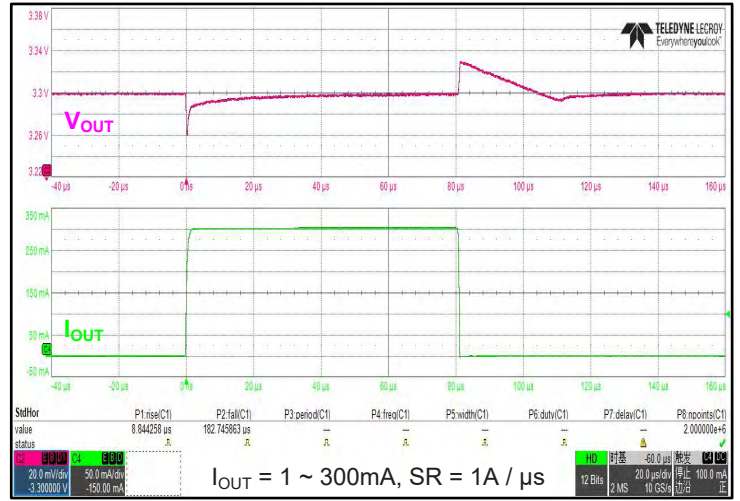
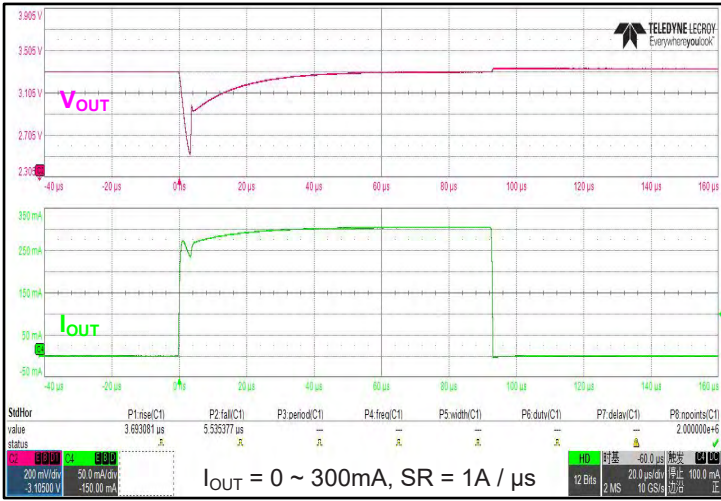

6 Specifications

6.6 Typical Characteristics (continued)

CJ6108 Series ($C_{IN} = 1\mu F$, $C_{OUT} = 1\mu F$, $T_A = 25^\circ C$, unless otherwise specified)

EN High ($V_{IN} = V_{OUT} + 1V$, $I_{OUT} = 10mA$)

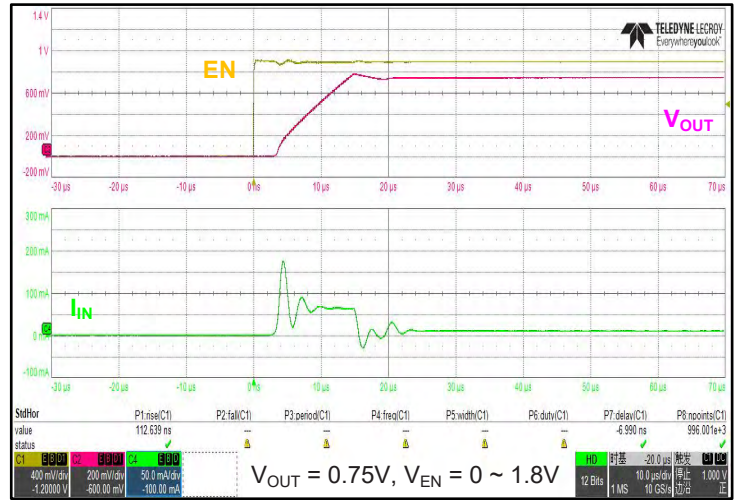
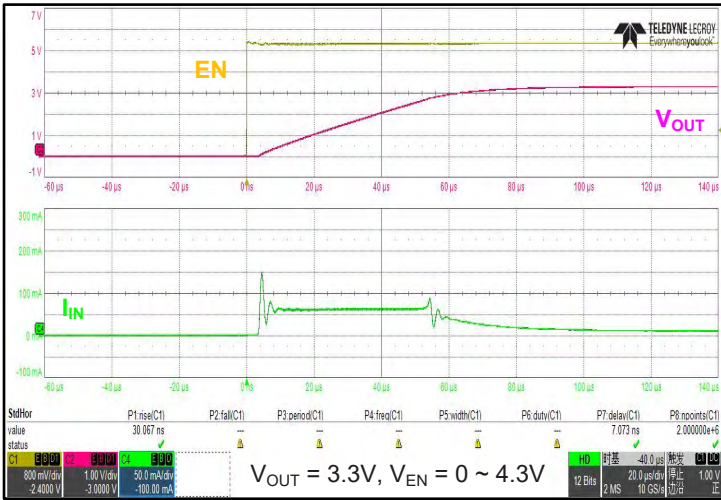

Power-up Response ($V_{EN} = V_{IN}$, $I_{OUT} = 1000mA$)

(Using electronic load as output)

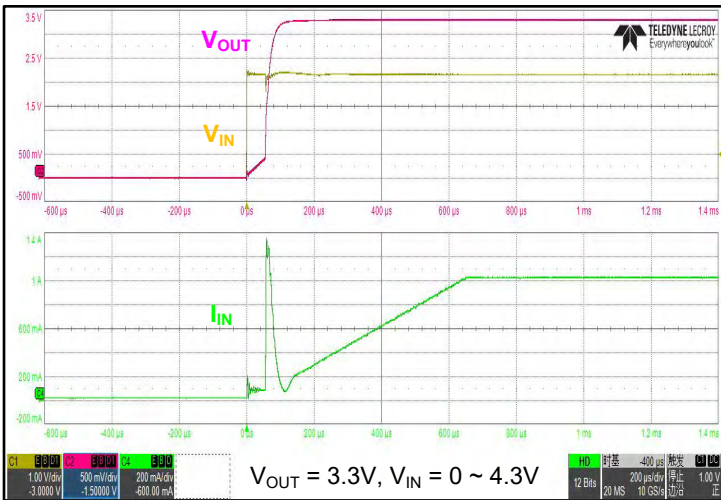

(Using electronic load as output)

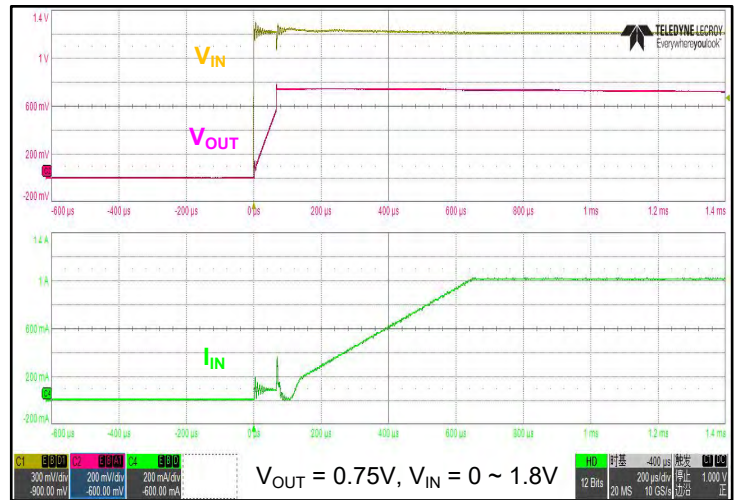

(Using resistance as output)

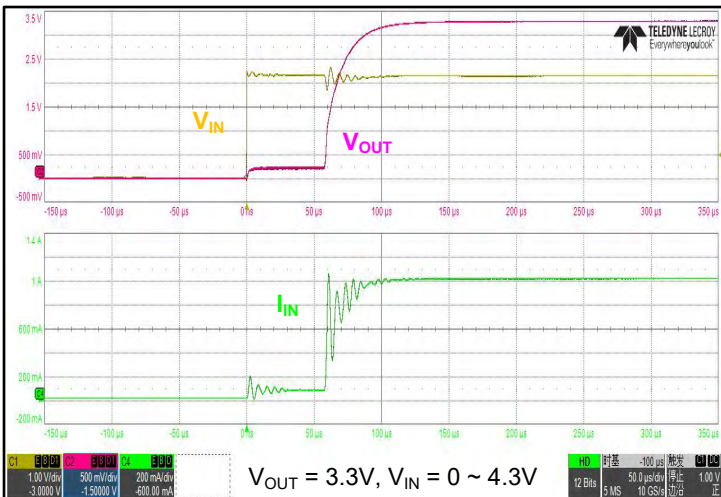

(Using resistance as output)

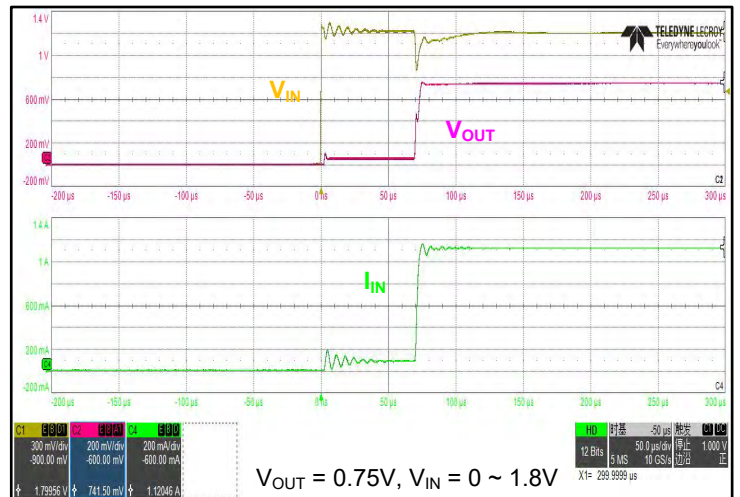

7 Detailed Description

7.1 Description

The CJ6108 series is a group of 6V, low-power consumption, low-dropout linear regulators (LDOs). The CJ6108 series supports fixed voltage output from 0.6V to 4.5V, which enables it to use fewer external components to provide better accuracy. The CJ6108 series has low I_Q performance and is internally integrated with current limiting, short-circuit protection and thermal shutdown protection, which makes it an ideal choice for battery power or line power applications.

7.2 Functional Block Diagram

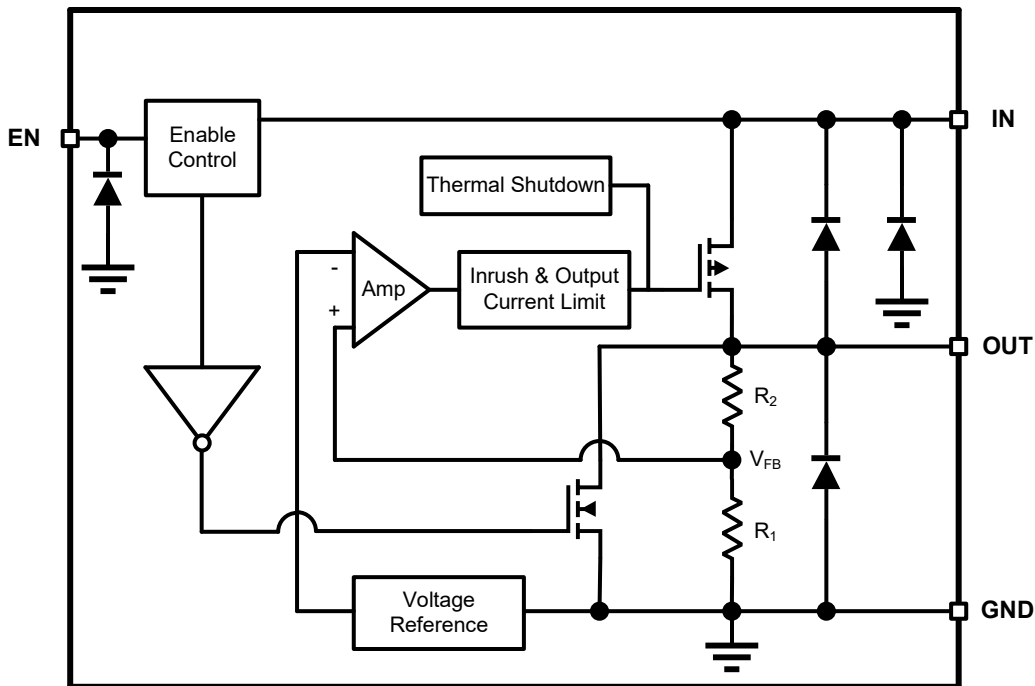

The internal feedback resistors R_1 and R_2 form a voltage divider circuit to compare the V_{FB} input error amplifier with the reference voltage. The internal regulator tube (PMOS) will control its conduction degree through the grid voltage provided by the error amplifier output, which will make the output voltage V_{OUT} not affected by temperature changes or input voltage changes to a certain extent, thus maintaining the stability of the device output voltage.

7 Detailed Description

7.3 Feature Description

Power Supply Input

When the input voltage is lower than the rated range of the data sheet, the device will lose the regulation function of stabilizing the output voltage, that is, it is unable to maintain the output voltage within the rated range. At this time, compared with normal operation, the quiescent current of the device may exceed the rated range, and the transient response performance may be seriously degraded.

When the input voltage is higher than the rated range of the data sheet, the device may cause irreversible damage or failure due to exceeding the maximum rated range of electrical stress.

For the rated input voltage of the device, see *Recommended Operating Conditions* and *Dropout Voltage*.

Output Current

When the circuit design is appropriate, the CJ6108 series can reach the maximum load capacity of up to 1000mA. According to the power dissipation of the package and the effective connection thermal resistance with the environment, selecting the appropriate package for the circuit design can make the device emit more heat energy.

Output Current Limit & Short Circuit Protection

The CJ6108 series has an internal current limiting circuit, which can protect the device by limiting the load current value in case of instantaneous high load current. When the current limiting is triggered, the output voltage is not regulated. If the out pin of the regulator is short circuited, the internal current limiting circuit will be triggered. The current limiting state will continue until the load current drops to the normal range.

When the load current of the device is large, the device will generate more heat due to the increase of power consumption, which may cause the device to turn off its output due to the internal thermal shutdown protection before the current limit is triggered. After the device cools down, the internal thermal shutdown circuit turns the device back on. If the fault condition continues, the device cycles between current limit and thermal shutdown.

In order to ensure the normal operation of current limit, the inductance of input and load shall be minimized. Continuous operation under current limit is not recommended.

Thermal Shutdown

The CJ6108 series has thermal shutdown protection mechanism. When the junction temperature T_J of the internal main channel MOSFET exceeds the thermal shutdown threshold temperature T_{SD} , thermal shutdown will be triggered. At this time, the output will be turned off to prevent catastrophic damage to the chip due to accidental heating. When the T_J drops to a certain range of thermal shutdown threshold temperature ΔT_{SD} , the thermal shutdown will be released and the device will return to the normal output. The temperature threshold of device triggering thermal shutdown T_{SD} and temperature range to be lowered to released from thermal shutdown ΔT_{SD} can be found in the *Electrical Characteristics*.

To ensure reliable operation, please limit the junction temperature to the specified range of *Recommended Operating Conditions* in the data sheet. Applications that exceed the recommended temperature range may cause the device to exceed its operating specifications.

Although the internal protection circuit of the device is designed to prevent overall thermal conditions, it is not intended to replace proper power dissipation. Running the device continuously until thermal shutdown or higher than the recommended operating T_J will reduce long-term reliability.

7 Detailed Description

7.3 Feature Description (continued)

Dropout Voltage

Dropout voltage V_{DO} refers to the minimum voltage difference between input and output $V_{IN} - V_{OUT}$ to make the device output voltage reach the rated range at rated current. When the dropout voltage condition required by the device is reached, the internal MOSFET will be fully turned on, at this time, the MOSFET is equivalent to a switch for regulation.

The V_{DO} increases with the increase of load current. Since $V_{IN} - V_{OUT}$ must be no less than the V_{DO} , the V_{DO} indirectly specifies the minimum input voltage of devices under different load current conditions. If the $V_{IN} - V_{OUT}$ is less than the V_{DO} , the performance of the device may deteriorate (see *Operation in Dropout Mode* for details).

Enable Control

The enable pin of the device EN is active at high level. When the voltage of the EN is greater than the EN logic high voltage V_{ENH} , the device will be enabled and maintain the normal output. When the voltage of the EN is lower than the EN logic low voltage V_{ENL} , the internal circuit of the device will be disabled and the output will be turned off, the device will be in the standby mode until EN is turned to high level again. The V_{ENH} and V_{ENL} can be found in the *Electrical Characteristics*.

Normal startup waveform and startup slope rate control can be ensured when the device starts from any low voltage lower than V_{ENL} , but the discharge time of output capacitor must be taken into account. EN can be float, when the EN is floating, it will be pulled down to ground internally. If EN is not required to control the output voltage independently, it's recommend to connect EN to IN.

Auto-discharge Function

The device with enable control has an auto-discharge circuit. When the enable control is turned off, the device will be disabled. An internally integrated pull-down MOSFET (see *Functional Block Diagram*) will connect a resistor $R_{Discharge}$ to the ground to release the charge in the output capacitor, thus closing the entire device circuit. The value of $R_{Discharge}$ can be found in the *Electrical Characteristics*. The discharge time of the output capacitor after the device is disabled is determined by the output capacitance C_{OUT} and load resistance R_L in parallel with the $R_{Discharge}$. The time constant τ can be calculated by the following formula:

$$\tau = C \times R_{Discharge} \quad (R_L = 0)$$

$$\tau = C \times \left(\frac{R_L \times R_{Discharge}}{R_L + R_{Discharge}} \right) \quad (R_L \neq 0)$$

The output voltage after discharging through pull-down MOSFET can be calculated by the following formula:

$$V = V_{OUT} \times e^{-\frac{t}{\tau}}$$

$$t = \tau \times \ln\left(\frac{V}{V_{OUT}}\right)$$

Where, V is the output voltage after discharge, V_{OUT} is the output voltage, t is the discharge time, τ is the discharge time constant.

Do not rely on the active discharge circuit to release a large amount of output capacitance after the input power supply crashes, because the reverse current can flow from the output to the input. This reverse current may damage the device. The limiting reverse current shall not exceed 5% of the rated current of the device.

8 Application and Implementation

8.1 Typical Application Circuits

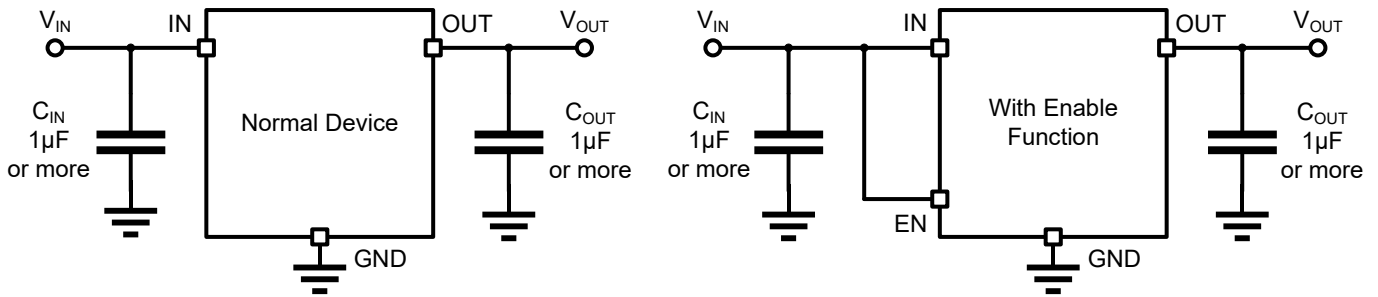

8.2 Application Information

Selection of Bypass Capacitances

For the CJ6108 series, it is recommended to use 1µF input (C_{IN}) and output (C_{OUT}) ceramic capacitors.

Type of Capacitors:

Since any leakage of the capacitor will increase the quiescent power consumption of the whole circuit, attention should be paid to selecting capacitors with low leakage. When designing the circuit of portable equipment including CJ6108 series, due to the shortage of tantalum capacitors, it is a good choice to use small size, low equivalent series resistance (ESR) and high RMS current capacity multilayer ceramic capacitors (MLCC) in the DC to DC voltage conversion. The designer must choose the appropriate capacitor type for circuit design: X7R- Ceramic capacitors of X5R- and COG- rated dielectric materials can provide relatively good capacitance stability within the temperature range, Y5V- type capacitors are not recommended because of large changes in capacitance values. However, no matter which type of ceramic capacitor is selected, the effective capacitance may vary with the operating voltage and temperature. The designer must consider the influence of the change of the effective value of capacitance according to the circuit design and application conditions.

Input Capacitors C_{IN} :

It is recommended to use a 1µF capacitor at the input pin of the device, and the position of the input capacitor should be as close to the device input pin as possible.

For the CJ6108 series, the input capacitor is not necessary to maintain the output stability, but it can offset the reactive input source and improve the transient response, input ripple and PSRR performance of the device. It should be noted that although many types of capacitors can be used for input bypass, using ceramic capacitors for input filtering may cause problems. Due to the self resonance and high Q characteristics of some types of ceramic capacitors, under certain starting conditions, applying voltage steps to ceramic capacitors may lead to large current surges (such as directly connecting the input pin of LDO to the power supply), which may cause some energy stored in the parasitic inductance of the power lead. When the stored energy is transferred from these inductors to ceramic capacitors, large voltage spikes may occur in the circuit. These voltage spikes are easily twice the step amplitude of the input voltage, and are likely to bring potential risks to the normal operation and reliability of the device. Therefore, the selection of ceramic capacitors as input capacitors must be careful. Adding 3Ω resistors and X5R- type ceramic capacitors will minimize voltage transients during startup. A higher value capacitor may be necessary if large, fast rise-time load or line transients are anticipated or if the device is located several inches from the input power source.

8 Application and Implementation

8.2 Application Information (continued)

Selection of Bypass Capacitances (continued)

Output Capacitors C_{OUT} :

Recommended 1 μ F output ceramic capacitor to keep the device output stable, and the capacitor position should be as close to the device pin as possible.

For CJ6108 series, the device needs an output capacitor to achieve loop stability. As with any regulator, a larger output capacitance reduces the peaks during a load transient but slows down the response time of the device. The proper capacitor can help to obtain better dynamic performance.

Transient Response

Transient response refers to the change of system output from initial state to stable state under the action of typical signal input. For LDO, the designer should pay attention to the possible impact of linear transient response and load transient response on the system: linear transient response refers to the transient response of output to change when the input voltage changes, while load transient response refers to the transient response of output to change when the output current changes. The specific phenomenon is that the output voltage of the device will have a short spike, especially when the input voltage or output current changes greatly in a short time. This change is not only related to the performance of the chip itself, but also related to the change of output current, change rate and output capacitance:

1. When the output current increases, the output voltage of the device will decrease to a certain extent, and the larger output current will provide a higher current discharge path for the output capacitor, which will affect the peak value generated by the transient spike and reduce the peak value;
2. The output current or input voltage changes relatively slowly, and the output change of the device is relatively small, affecting the spike caused by the change;
3. The use of large input and output capacitors can reduce the spike caused by transient response to a certain extent to improve the transient performance, but large output capacitors can also affect the response time of devices.

For the selection of bypass capacitance value, refer to the *Section of Bypass Capacitances* selection.

Operation in Dropout Mode

The CJ6108 series is internally integrated with a P-MOSFET to achieve low dropout voltage. The voltage difference between the input and the output $V_{IN} - V_{OUT}$ of the device must not be lower than the corresponding dropout voltage V_{DO} to ensure that the output voltage tolerance is within the rated range of the data sheet. The dropout voltage will increase with the increase of load current. When the $V_{IN} - V_{OUT}$ is less than the V_{DO} , the P-MOSFET inside the device is in a linear state, the resistance from the input pin to the output pin is equal to the resistance from the drain to the source of the P-MOSFET, and the device functions like a resistor. When operating in this state, the response time of the error amplifier inside the device will be limited, which will seriously degrade the transient performance of the device, when the external circuit has a transient change, the deviation of the output voltage will become larger than the normal operating state. In addition, the PSRR and noise performance of the device will be worse than that under normal operating conditions.

8 Application and Implementation

8.2 Application Information (continued)

Recommended Continuous Operating Areas

As an LDO, the working area of CJ6108 series is limited by dropout voltage, output current, junction temperature and input voltage under continuous working condition. The recommended areas for continuous operation are shown in Figure 8-1:

- A. The LDO input and output voltage difference $V_{IN} - V_{OUT}$ must meet the dropout voltage V_{DO} conditions. See *Dropout Voltage* for more details.
- B. Rated output current range I_{Rated} .
- C. The actual junction temperature T_J of LDO shall not exceed the rated junction temperature. The product of voltage difference and current at both ends of LDO is power consumption, which determines the actual working junction temperature of LDO, so the curve is not linear.

In addition, the working area of CJ6108 series is limited by the rated $V_{IN MIN}$ and $V_{IN MAX}$.

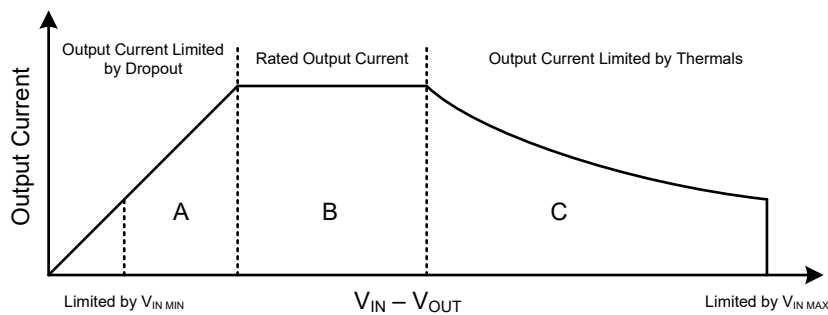

Figure 8-1. Region Description for Continuous Operation

8.3 Power Supply Recommendation

The CJ6108 series is designed to operate within the input power supply voltage range of 1.0V to 6.0V. The input power supply should be well adjusted and have low noise. If the input power supply has high noise, it is recommended to use an additional bypass capacitor at the input to improve the output noise performance of the device. It is recommended to use an input capacitor of 1 μ F or higher to reduce the impedance of the input power supply, especially during transients.

8.4 Layout Guidelines

When designing the circuit including CJ6108 series, the following matters should be noted:

- Place the input and output capacitors as close to the pins of the device as possible;
- The device is connected by copper plane and the heat sink (or back pad) of the device is fully welded with PCB to obtain better heat dissipation performance and lower on resistance;
- Heat sink holes are placed around the device to help the circuit dissipate more heat energy. However, attention should be paid to the position of the heat sink holes to prevent the solder (or solder paste) on the IC pad from being absorbed by the heat sink holes and being damaged during welding.

NOTE

The application information in this section is not part of the data sheet component specification, and JSCJ makes no commitment or statement to guarantee its accuracy or completeness. Customers are responsible for determining the rationality of corresponding components in their circuit design and making tests and verifications to ensure the normal realization of their circuit design.

9 Notes and Revision History

9.1 Associated Product Family and Others

To view other products of the same type or IC products of other types, click the official website of JSCJ -- <https://www.jscj-elec.com> for more details.

9.2 Notes

Electrostatic Discharge Caution



This IC may be damaged by ESD. Relevant personnel shall comply with correct installation and use specifications to avoid ESD damage to the IC. If appropriate measures are not taken to prevent ESD damage, the hazards caused by ESD include but are not limited to degradation of integrated circuit performance or complete damage of integrated circuit. For some precision integrated circuits, a very small parameter change may cause the whole device to be inconsistent with its published specifications.

9.3 Revision History

May, 2025: changed from rev - 1.1 to rev - 1.2:

- Page 5, Recommended Operating Conditions, removed Operated ambient temperature T_A .
- Addendum-Page 1~2 , Orderable Information, changed OP TEMP from $-40 \sim 85^{\circ}\text{C}$ to $-40 \sim 125^{\circ}\text{C}$.

November, 2024: changed from rev - 1.0 to rev - 1.1:

- Delete the package information about WBHFBP-06L and add the package information about DFNWB2×2-6L.
- Added new active products.

March, 2024: released CJ6108 series rev - 1.0.

DISCLAIMER

IMPORTANT NOTICE, PLEASE READ CAREFULLY

The information in this data sheet is intended to describe the operation and characteristics of our products. JSCJ has the right to make any modification, enhancement, improvement, correction or other changes to any content in this data sheet, including but not limited to specification parameters, circuit design and application information, without prior notice.

Any person who purchases or uses JSCJ products for design shall: 1. Select products suitable for circuit application and design; 2. Design, verify and test the rationality of circuit design; 3. Procedures to ensure that the design complies with relevant laws and regulations and the requirements of such laws and regulations. JSCJ makes no warranty or representation as to the accuracy or completeness of the information contained in this data sheet and assumes no responsibility for the application or use of any of the products described in this data sheet.

Without the written consent of JSCJ, this product shall not be used in occasions requiring high quality or high reliability, including but not limited to the following occasions: medical equipment, military facilities and aerospace. JSCJ shall not be responsible for casualties or property losses caused by abnormal use or application of this product.

Official Website: www.jscj-elec.com

Copyright © JIANGSU CHANGJING ELECTRONICS TECHNOLOGY CO., LTD.

Orderable Information

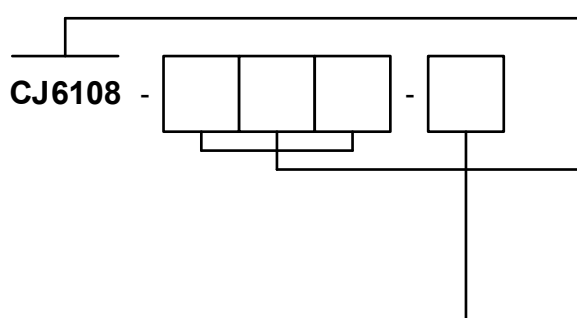

Device serial number.

Package type.

M3N: SOT-23-3L M5N: SOT-23-5L
P3N: SOT-89-3L P3L: SOT-89-3L
G3N: SOT-223 G3W: SOT-223
DAN: DFNWB1×1-4L DBA: DFNWB2×2-6L
DHN: DFNWB1.2×1.2-4L

Output voltage.

0.75: Fixed output 0.75V 1.8: Fixed output 1.8V
0.8: Fixed output 0.8V 2.8: Fixed output 2.8V
1.1: Fixed output 1.1V 3.0: Fixed output 3.0V
1.2: Fixed output 1.2V 3.3: Fixed output 3.3V
1.3: Fixed output 1.1V

Figure A-1. Naming Conventions

MODEL	DEVICE	PACKAGE	OP TEMP	ECO PLAN	MSL	PACKING OPTION	SORT
3 Pins Packaged Products							
CJ6108-1.3	CJ6108-M3N-1.3	SOT-23-3L	-40 ~ 125°C	RoHS & Green	Level 3 168 HR	Tape and Reel 3000 Units / Reel	Active
CJ6108-3.3	CJ6108-P3N-3.3	SOT-89-3L	-40 ~ 125°C	RoHS & Green	Level 3 168 HR	Tape and Reel 1000 Units / Reel	Active
CJ6108-3.3	CJ6108-G3W-3.3	SOT-223	-40 ~ 125°C	RoHS & Green	Level 3 168 HR	Tape and Reel 2500 Units / Reel	Active
CJ6108-3.3	CJ6108-G3N-3.3	SOT-223	-40 ~ 125°C	RoHS & Green	Level 3 168 HR	Tape and Reel 2500 Units / Reel	Active
4 Pins Packaged Products							
CJ6108-1.05	CJ6108-DAN-1.05	DFNWB1×1-4L	-40 ~ 125°C	RoHS & Green	Level 3 168 HR	Tape and Reel 10000 Units / Reel	Active
CJ6108-1.1	CJ6108-DAN-1.1	DFNWB1×1-4L	-40 ~ 125°C	RoHS & Green	Level 3 168 HR	Tape and Reel 10000 Units / Reel	Active
CJ6108-1.2	CJ6108-DAN-1.2	DFNWB1×1-4L	-40 ~ 125°C	RoHS & Green	Level 3 168 HR	Tape and Reel 10000 Units / Reel	Active
CJ6108-1.8	CJ6108-DAN-1.8	DFNWB1×1-4L	-40 ~ 125°C	RoHS & Green	Level 3 168 HR	Tape and Reel 10000 Units / Reel	Active
CJ6108-2.8	CJ6108-DAN-2.8	DFNWB1×1-4L	-40 ~ 125°C	RoHS & Green	Level 3 168 HR	Tape and Reel 10000 Units / Reel	Active
CJ6108-3.0	CJ6108-DAN-3.0	DFNWB1×1-4L	-40 ~ 125°C	RoHS & Green	Level 3 168 HR	Tape and Reel 10000 Units / Reel	Active
CJ6108-3.3	CJ6108-DAN-3.3	DFNWB1×1-4L	-40 ~ 125°C	RoHS & Green	Level 3 168 HR	Tape and Reel 10000 Units / Reel	Active

Orderable Information

MODEL	DEVICE	PACKAGE	OP TEMP	ECO PLAN	MSL	PACKING OPTION	SORT
5 Pins Packaged Products							
CJ6108-1.8	CJ6108-M5N-1.8	SOT-23-5L	-40 ~ 125°C	RoHS & Green	Level 3 168 HR	Tape and Reel 3000 Units / Reel	Active
CJ6108-2.8	CJ6108-M5N-2.8	SOT-23-5L	-40 ~ 125°C	RoHS & Green	Level 3 168 HR	Tape and Reel 3000 Units / Reel	Active
CJ6108-3.3	CJ6108-M5N-3.3	SOT-23-5L	-40 ~ 125°C	RoHS & Green	Level 3 168 HR	Tape and Reel 3000 Units / Reel	Active
Customized Products							
CJ6108-x.x	CJ6108-P3N-x.x	SOT-89-3L	-40 ~ 125°C	RoHS & Green	Level 3 168 HR	Tape and Reel 1000 Units / Reel	Customized
	CJ6108-P3L-x.x	SOT-89-3L	-40 ~ 125°C	RoHS & Green	Level 3 168 HR	Tape and Reel 1000 Units / Reel	Customized
	CJ6108-G3N-x.x	SOT-223	-40 ~ 125°C	RoHS & Green	Level 3 168 HR	Tape and Reel 2500 Units / Reel	Customized
	CJ6108-G3W-x.x	SOT-223	-40 ~ 125°C	RoHS & Green	Level 3 168 HR	Tape and Reel 2500 Units / Reel	Customized
	CJ6108-M5N-x.x	SOT-23-5L	-40 ~ 125°C	RoHS & Green	Level 3 168 HR	Tape and Reel 3000 Units / Reel	Customized
	CJ6108-DAN-x.x	DFNWB1×1-4L	-40 ~ 125°C	RoHS & Green	Level 3 168 HR	Tape and Reel 10000 Units / Reel	Customized
	CJ6108-DHN-x.x	DFNWB1.2×1.2-4L	-40 ~ 125°C	RoHS & Green	Level 3 168 HR	Tape and Reel 5000 Units / Reel	Customized
	CJ6108-DBA-x.x	DFNWB2×2-6L	-40 ~ 125°C	RoHS & Green	Level 3 168 HR	Tape and Reel 3000 Units / Reel	Customized
Others	-	-	-	-	-	-	Customized

Note:

ECO PLAN: For the RoHS and Green certification standards of this product, please refer to the official report provided by JSCJ.

MSL: Moisture Sensitivity Level. Determined according to JEDEC industry standard classification.

SORT: Specifically defined as follows:

Active: Recommended for new products;

Customized: Products manufactured to meet the specific needs of customers;

Preview: The device has been released and has not been fully mass produced. The sample may or may not be available;

NoRD: It is not recommended to use the device for new design. The device is only produced for the needs of existing customers;

Obsolete: The device has been discontinued.

10 Mechanical Information

SOT-89-3L Mechanical Information

SOT-89-3L Outline Dimensions

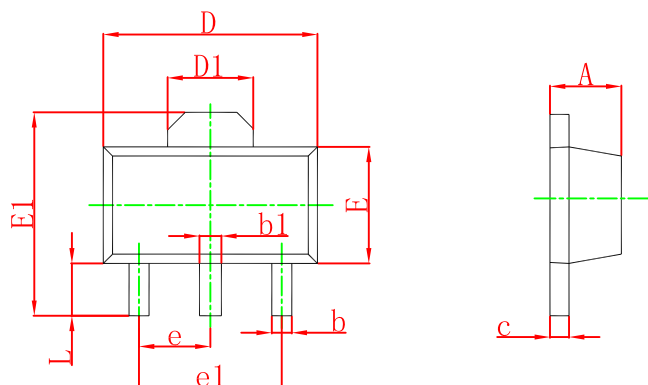

Symbol	Dimensions In Millimeters		Dimensions In Inches	
	Min.	Max.	Min.	Max.
A	1.400	1.600	0.055	0.063
b	0.320	0.520	0.013	0.197
b1	0.400	0.580	0.016	0.023
c	0.350	0.440	0.014	0.017
D	4.400	4.600	0.173	0.181
D1	1.550 REF		0.061 REF	
E	2.300	2.600	0.091	0.102
E1	3.940	4.250	0.155	0.167
e	1.500 TYP		0.060 TYP	
e1	3.000 TYP		0.118 TYP	
L	0.900	1.200	0.035	0.047

SOT-89-3L Suggested Pad Layout

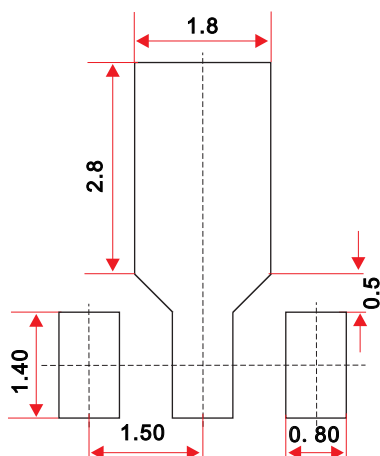

Note:

1. Controlling dimension: in millimeters.
2. General tolerance: $\pm 0.05\text{mm}$.
3. The pad layout is for reference purpose only.

10 Mechanical Information

SOT-223 Mechanical Information

SOT-223 Outline Dimensions

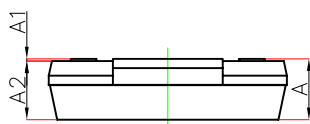
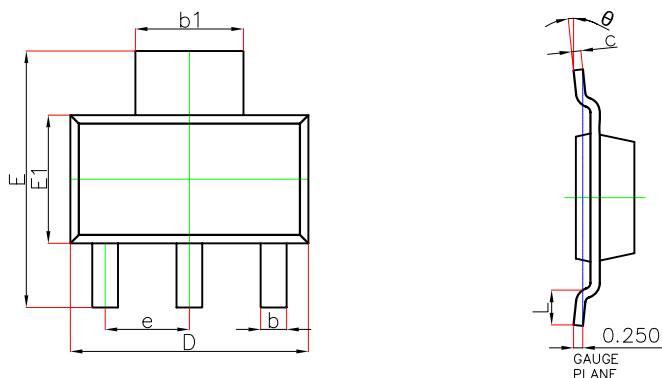

Symbol	Dimensions In Millimeters		Dimensions In Inches	
	Min.	Max.	Min.	Max.
A	—	1.800	—	0.071
A1	0.020	0.100	0.001	0.004
A2	1.500	1.700	0.059	0.067
b	0.660	0.840	0.026	0.033
b1	2.900	3.100	0.114	0.122
c	0.230	0.350	0.009	0.014
D	6.300	6.700	0.248	0.264
E	6.700	7.300	0.264	0.287
E1	3.300	3.700	0.130	0.146
e	2.300(BSC)		0.091(BSC)	
L	0.750	—	0.030	—
θ	0°	10°	0°	10°

SOT-223 Suggested Pad Layout

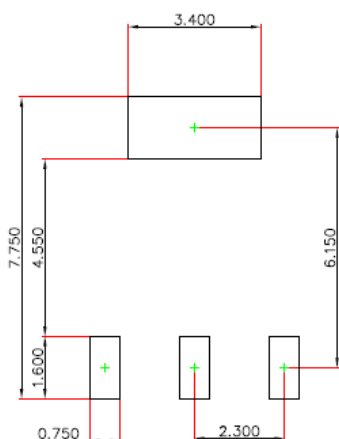

Note:

1. Controlling dimension: in millimeters.
2. General tolerance: $\pm 0.05\text{mm}$.
3. The pad layout is for reference purpose only.

10 Mechanical Information

10.3 SOT-23-5L Mechanical Information

SOT-23-5L Outline Dimensions

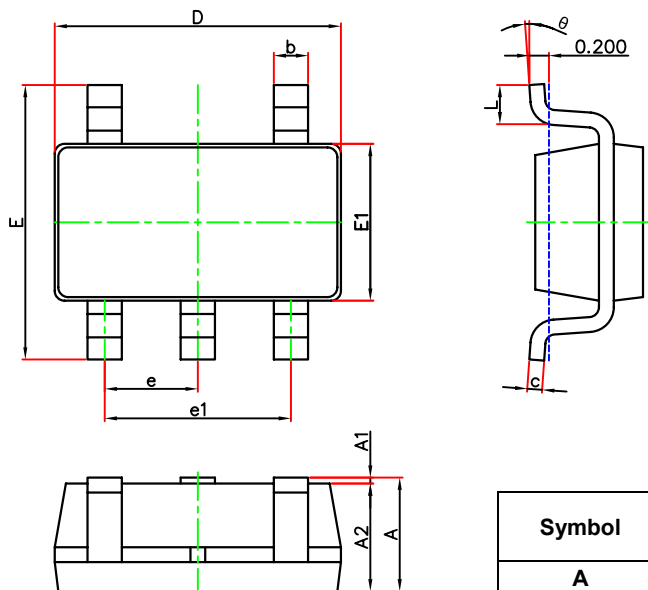

Symbol	Dimensions In Millimeters		Dimensions In Inches	
	Min.	Max.	Min.	Max.
A	1.050	1.250	0.041	0.049
A1	0.000	0.100	0.000	0.004
A2	1.050	1.150	0.041	0.045
b	0.300	0.500	0.012	0.020
c	0.100	0.200	0.004	0.008
D	2.820	3.020	0.111	0.119
E	2.650	2.950	0.104	0.116
E1	1.500	1.700	0.059	0.067
e	0.950(BSC)		0.037(BSC)	
e1	1.800	2.000	0.071	0.079
L	0.300	0.600	0.012	0.024
θ	0°	8°	0°	8°

SOT-23-5L Suggested Pad Layout

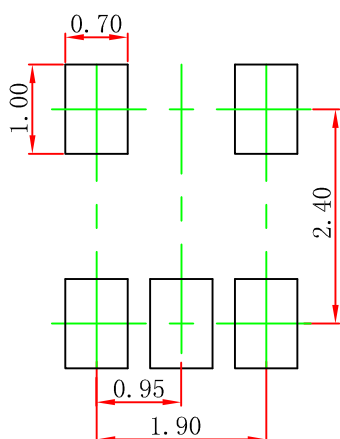

Note:

1. Controlling dimension: in millimeters.
2. General tolerance: $\pm 0.05\text{mm}$.
3. The pad layout is for reference purpose only.

10 Mechanical Information

10.4 DFNWB2×2-6L Mechanical Information

DFNWB2×2-6L Outline Dimensions

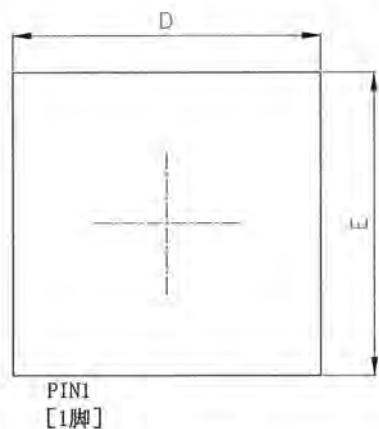

Top View

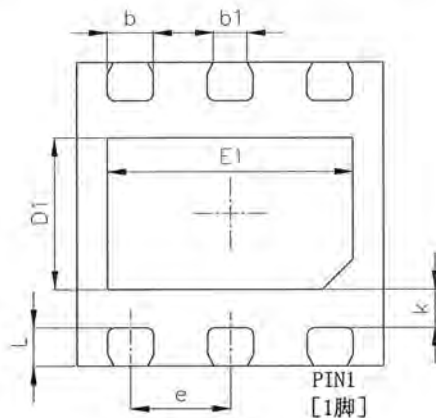

Bottom View

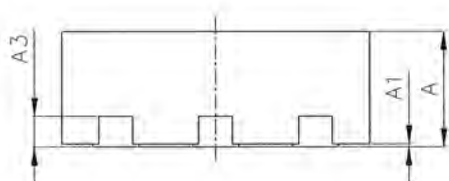

Side View

SYMBOL	DISMENSIONS IN MILLIMETERS			DISMENSIONS IN INCHES		
	MIN	NOM	MAX	MIN	NOM	MAX
A	0.700	0.750	0.800	0.028	0.030	0.031
A1	0.000	0.025	0.050	0.000	0.001	0.002
A3	0.203 REF.			0.008 REF.		
D	1.900	2.000	2.100	0.075	0.079	0.083
E	1.900	2.000	2.100	0.075	0.079	0.083
D1	0.900	1.000	1.100	0.035	0.039	0.043
E1	1.500	1.600	1.700	0.059	0.063	0.067
k	0.250 REF.			0.010 REF.		
b	0.250	0.300	0.350	0.010	0.012	0.014
b1	0.220 REF.			0.009 REF.		
e	0.650 REF.			0.026 REF.		
L	0.200	0.250	0.300	0.008	0.010	0.012

10 Mechanical Information

10.5 DFNWB1×1-4L Mechanical Information

DFNWB1×1-4L Outline Dimensions

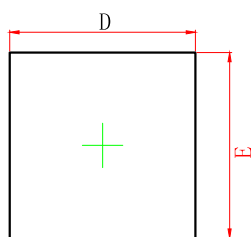

TOP VIEW

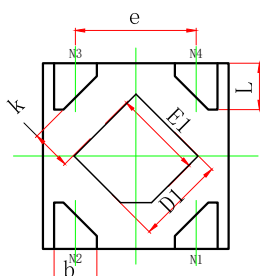

BOTTOM VIEW

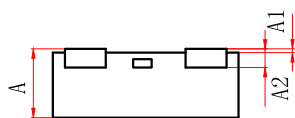

SIDE VIEW

Symbol	Dimensions In Millimeters		Dimensions In Inches	
	Min.	Max.	Min.	Max.
A	0.320	0.400	0.013	0.016
A1	0.000	0.050	0.000	0.002
A2	0.100 REF.		0.004 REF.	
D	0.950	1.050	0.037	0.041
E	0.950	1.050	0.037	0.041
D1	0.430	0.530	0.017	0.021
E1	0.430	0.530	0.017	0.021
k	0.150MIN.		0.006MIN.	
b	0.180	0.280	0.007	0.011
e	0.650TYP.		0.026TYP.	
L	0.200	0.300	0.008	0.012
L1	0.200	0.300	0.008	0.012

DFNWB1×1-4L Suggested Pad Layout

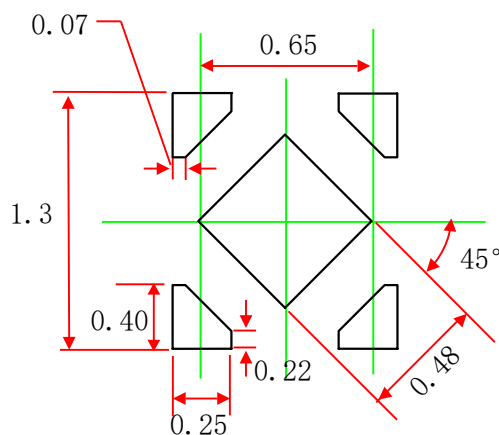

Note:

1. Controlling dimension: in millimeters.
2. General tolerance: $\pm 0.05\text{mm}$.
3. The pad layout is for reference purpose only.

11 Packaging Information

11.1 SOT-89-3L Tape and Reel Information

SOT-89-3L Embossed Carrier Tape

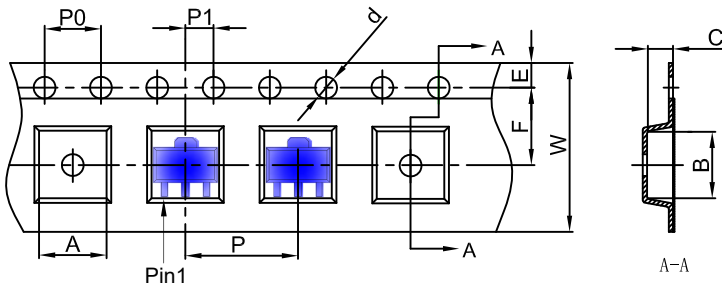

Packaging Description:
 SOT-89-3L parts are shipped in tape. The carrier tape is made from a dissipative (carbon filled) polycarbonate resin. The cover tape is a multilayer film (Heat Activated Adhesive in nature) primarily composed of polyester film, adhesive layer, sealant, and anti-static sprayed agent. These reeled parts in standard option are shipped with 1,000 units per 7" or 18.0 cm diameter reel. The reels are clear in color and is made of polystyrene plastic (anti-static coated).

Dimensions are in millimeter										
Pkg type	A	B	C	d	E	F	P0	P	P1	W
SOT-89-3L	4.85	4.45	1.85	Ø1.50	1.75	5.50	4.00	8.00	2.00	12.00

SOT-89-3L Tape Leader and Trailer

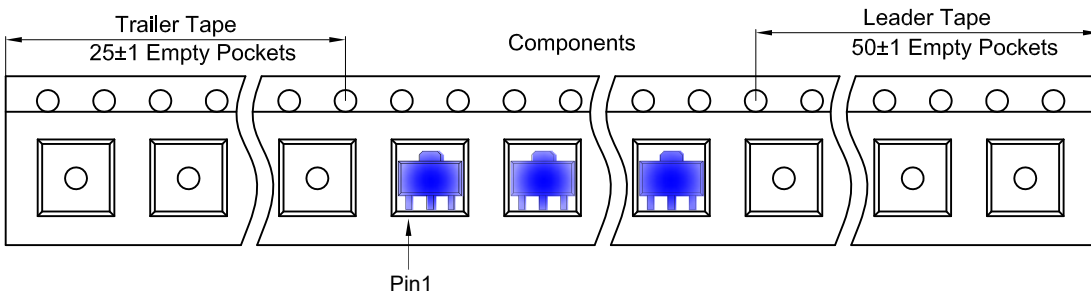

SOT-89-3L Reel

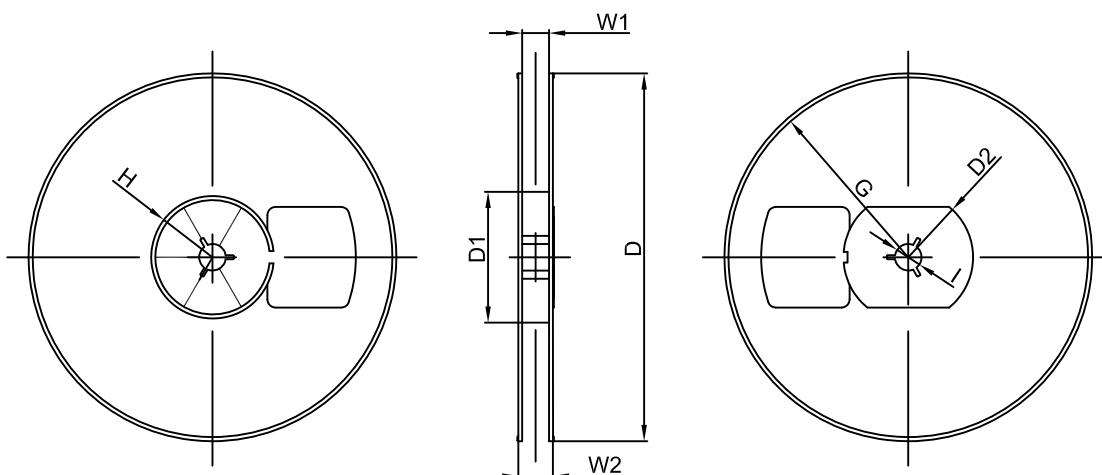

Dimensions are in millimeter								
Reel Option	D	D1	D2	G	H	I	W1	W2
7" Dia	Ø180.00	60.00	R32.00	R86.50	R30.00	Ø13.00	13.20	16.50

REEL	Reel Size	Box	Box Size(mm)	Carton	Carton Size(mm)	G.W.(kg)
1000 pcs	7 inch	10,000 pcs	203×203×195	40,000 pcs	438×438×220	

11 Packaging Information

11.2 SOT-223- Tape and Reel Information

SOT-223 Tape and Reel Information

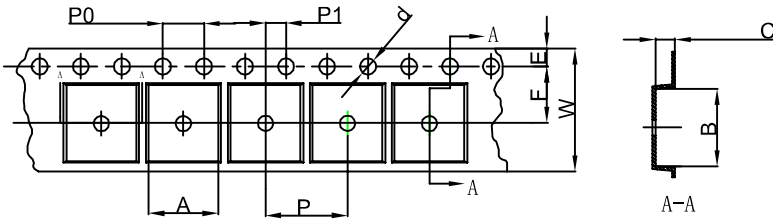

Packaging Description:

SOT-223 parts are shipped in tape. The carrier tape is made from a dissipative (carbon filled) polycarbonate resin. The cover tape is a multilayer film (Heat Activated Adhesive in nature) primarily composed of polyester film, adhesive layer, sealant, and anti-static sprayed agent. These reeled parts in standard option are shipped with 2,500 units per 13" or 33.0cm diameter reel. The reels are clear in color and is made of polystyrene plastic (anti-static coated),

Dimensions are in millimeter										
Pkg type	A	B	C	d	E	F	P0	P	P1	W
SOT-223	6.765	7.335	1.88	Ø1.50	1.75	5.50	4.00	8.00	2.00	12.00

SOT-223 Tape Leader and Trailer

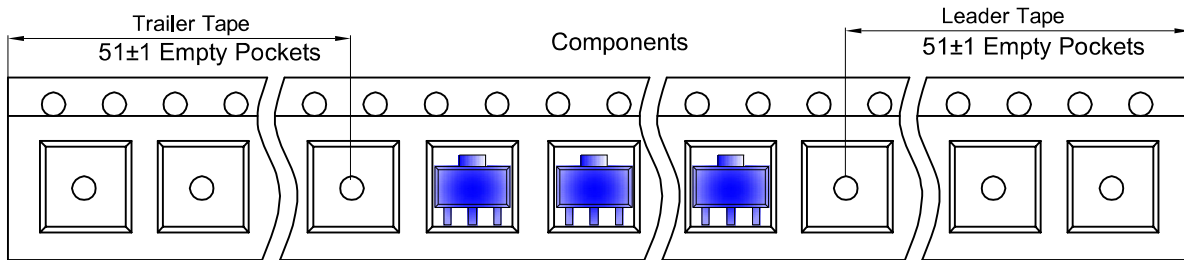

SOT-223 Reel

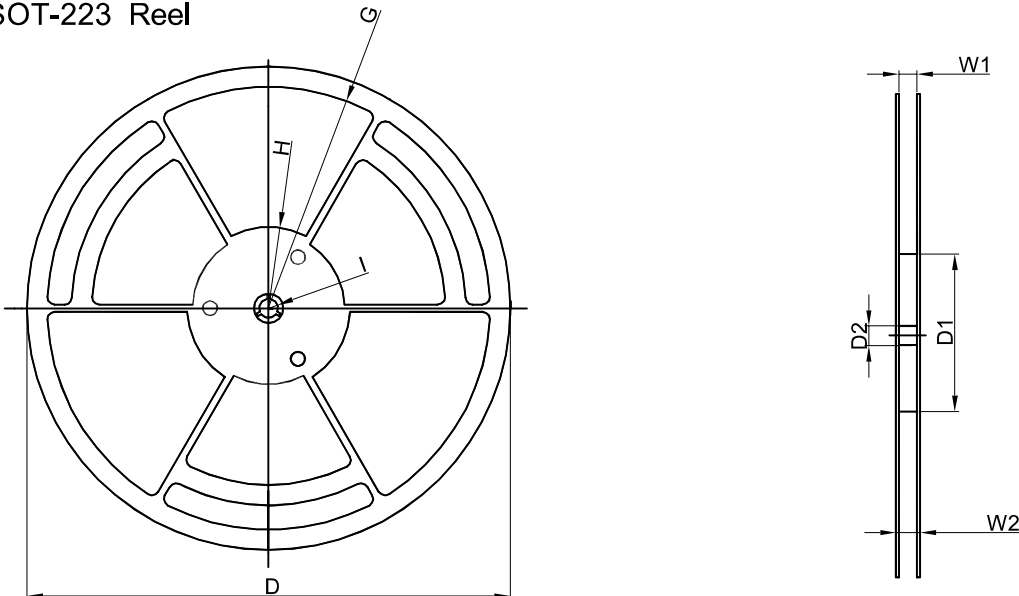

Dimensions are in millimeter								
Reel Option	D	D1	D2	G	H	I	W1	W2
13" Dia	φ330.00	100.00	13.00	R151.00	R56.00	R6.50	12.40	17.60

Reel	Reel Size	Box	Box Size (mm)	Carton	Carton Size (mm)
2,500 pcs	13 inch	5,000 pcs	360×360×65	25,000 pcs	378×358×382

11 Packaging Information

11.3 SOT-23-5L Tape and Reel Information

SOT-23-5L Tape and Reel Information

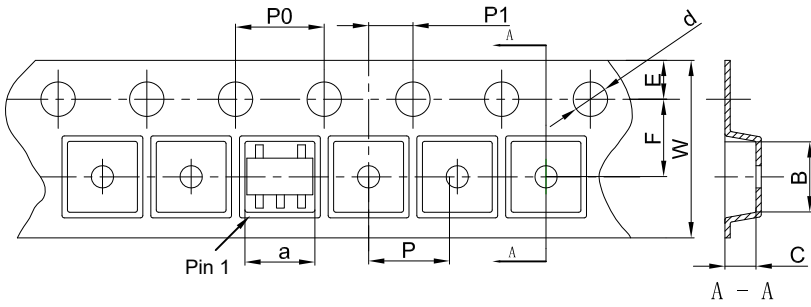

Packaging Description:

SOT-23-5L parts are shipped in tape. The carrier tape is made from a dissipative (carbon filled) polycarbonate resin. The cover tape is a multilayer film (Heat Activated Adhesive in nature) primarily composed of polyester film, adhesive layer, sealant, and anti-static sprayed agent. These reeled parts in standard option are shipped with 3,000 units per 7" or 18.0cm diameter reel. The reels are clear in color and is made of polystyrene plastic (anti-static coated).

Dimensions are in millimeter										
Pkg type	a	B	C	d	E	F	P0	P	P1	W
SOT-23-5L	3.17	3.23	1.37	Ø1.55	1.75	3.50	4.00	4.00	2.00	8.00

SOT-23-5L Tape Leader and Trailer

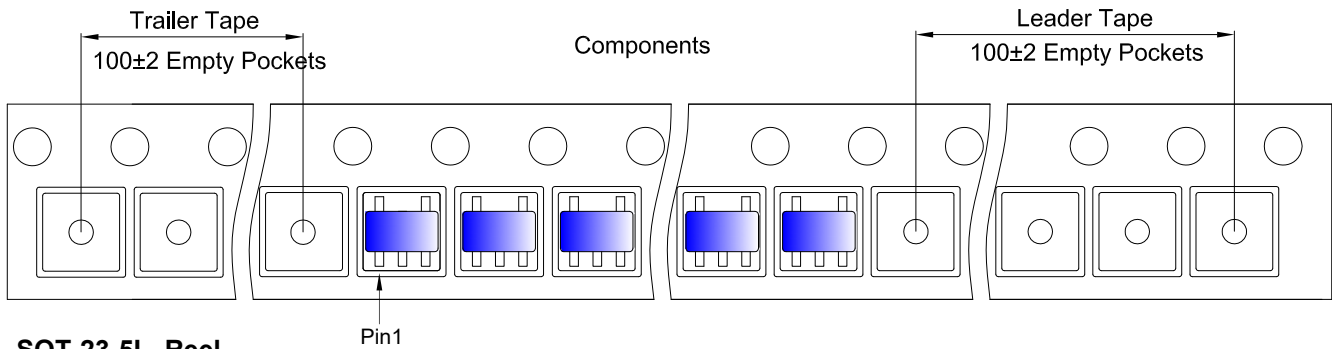

SOT-23-5L Reel

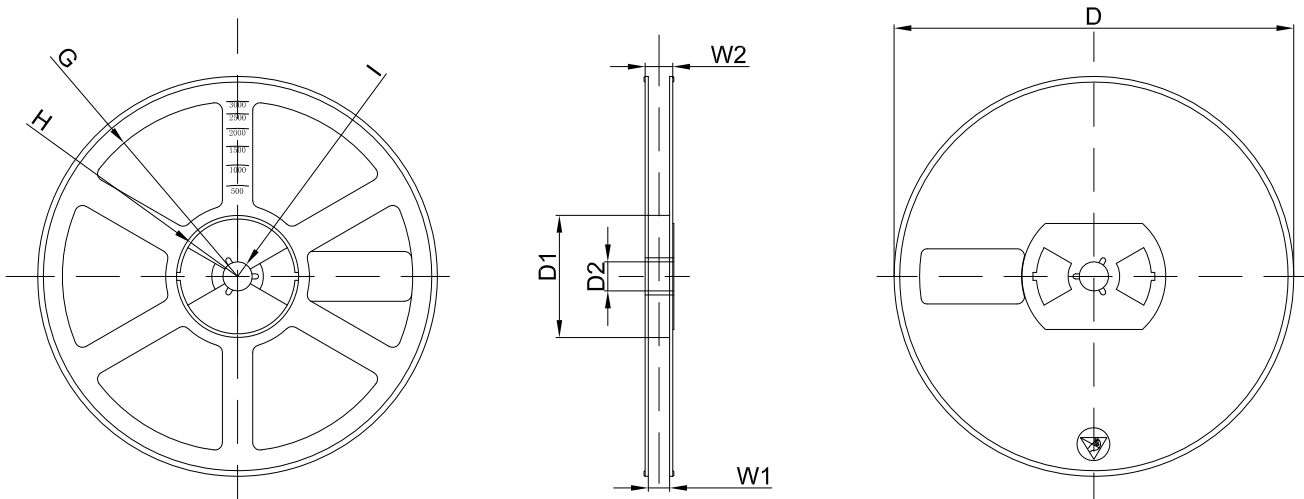

Dimensions are in millimeter								
Reel Option	D	D1	D2	G	H	I	W1	W2
7" Dia	Ø180.00	60.00	13.00	R78.00	R25.60	R6.50	9.50	13.10

REEL	Reel Size	Box	Box Size(mm)	Carton	Carton Size(mm)	G.W.(kg)
3000 pcs	7 inch	30,000 pcs	203×203×195	120,000 pcs	438×438×220	

11 Packaging Information

11.4 DFNWB1×1-4L Tape and Reel Information

DFNWB1×1-4L Embossed Carrier Tape

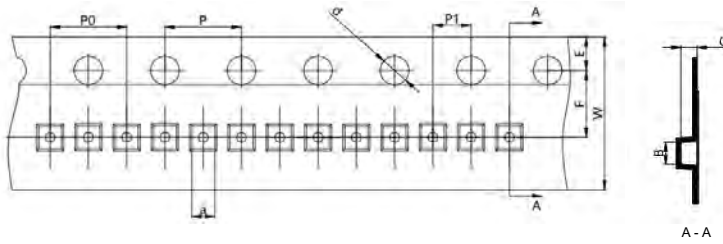

Packaging Description:

DFNWB1×1-4L parts are shipped in tape. The carrier tape is made from a dissipative (carbon filled) polycarbonate resin. The cover tape is a multilayer film (Heat Activated Adhesive in nature) primarily composed of polyester film, adhesive layer, sealant, and anti-static sprayed agent. These reeled parts in standard option are shipped with 3,000 units per 7" or 18.0cm diameter reel. The reels are clear in color and is made of polystyrene plastic (anti-static coated).

Dimensions are in millimeter										
Pkg type	a	B	C	d	E	F	P0	P	P1	W
DFNWB1×1-4L	1.12	1.13	0.50	1.55	1.75	3.5	4.00	4.00	2.00	8.00

DFNWB1×1-4L Tape Leader and Trailer

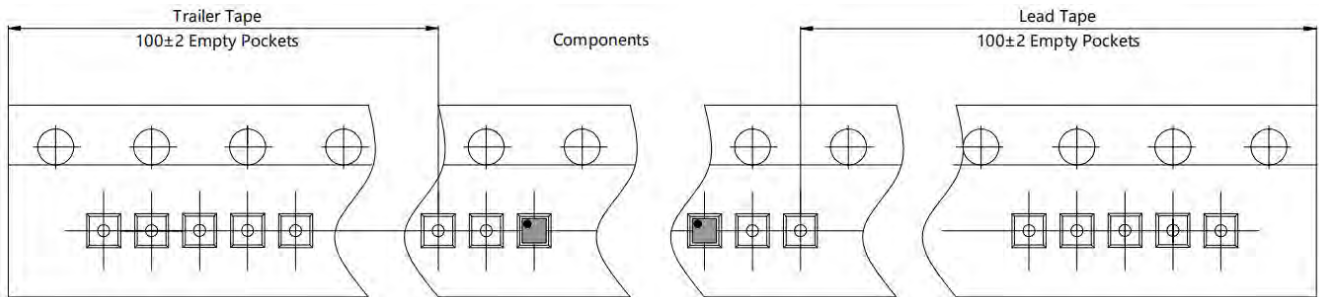

DFNWB1×1-4L Reel

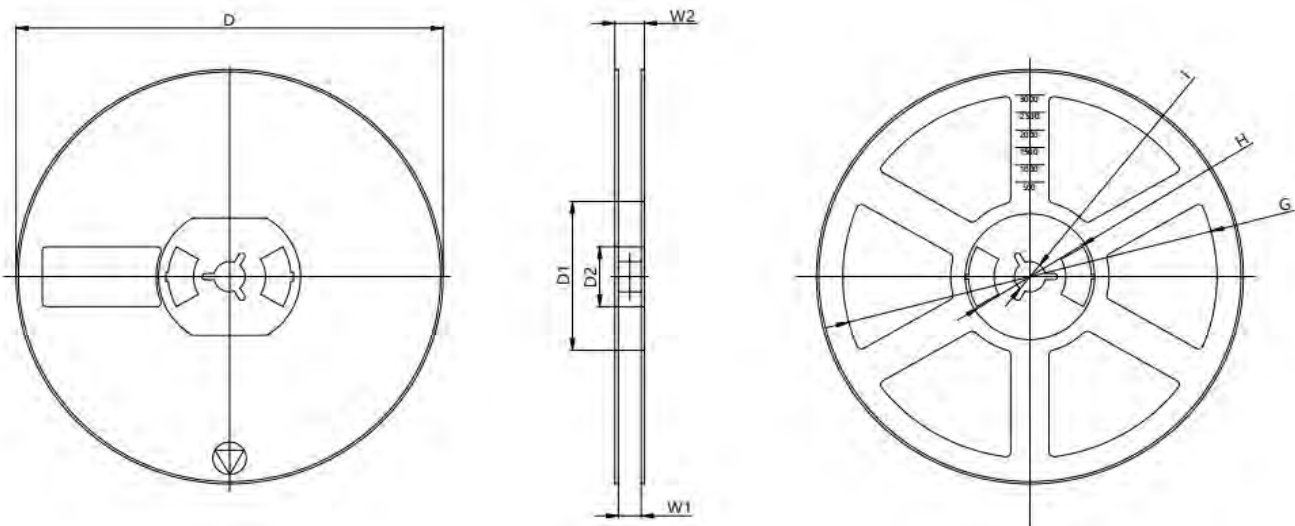

Dimensions are in millimeter								
Reel Option	D	D1	D2	G	H	I	W1	W2
7" Dia	∅ 178.00	54.5	13.5	R78.0	R25.6	R6.75	9.6	12.3

REEL	Reel Size	Box	Box Size(mm)	Carton	Carton Size(mm)	G.W.(kg)
10,000 pcs	7 inch	100,000pcs	210×208×205	400,000 pcs	440×440×230	