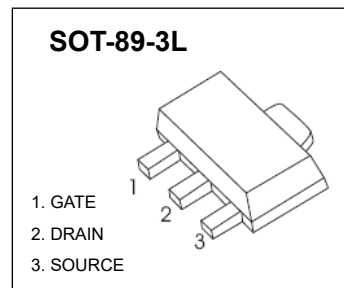

**SOT-89-3L Plastic-Encapsulate MOSFETS****CJA03N06** N-Channel MOSFET

$V_{(BR)DSS}$	$R_{DS(on)}$ TYP	I_D
60 V	38mΩ@10V	3A
	40mΩ@4.5V	

**DESCRIPTION**

The CJA03N06 uses advanced trench technology and design to provide excellent $R_{DS(ON)}$ with low gate charge. This device is suitable for use in a wide variety of applications.

FEATURES

- Lead free product is acquired
- Special process technology for high ESD capability
- High density cell design for ultra low $R_{DS(on)}$
- Excellent package for good heat dissipation

APPLICATION

- Power switching application
- Hard switching and high frequency circuits
- Uninterruptible power supply

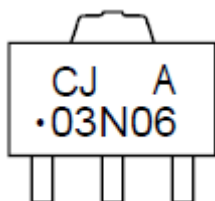
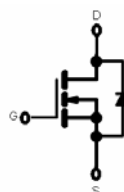
MARKING**Equivalent Circuit****Maximum ratings ($T_J=25^\circ\text{C}$ unless otherwise noted)**

Parameter	Symbol	Value	Unit
Drain-Source Voltage	V_{DS}	60	V
Gate-Source Voltage	V_{GS}	± 20	V
Continuous Drain Current	I_D	3	A
Pulsed Drain Current	$I_{DM}^{(2)}$	12	A
Power Dissipation	$P_D^{(5)}$	0.9	W
Thermal Resistance from Junction to Ambient	$R_{\theta JA}^{(5)}$	140	$^\circ\text{C/W}$
Storage and Junction Temperature	T_{STG}, T_J	-55~+150	$^\circ\text{C}$

MOSFET ELECTRICAL CHARACTERISTICS

$T_J=25^{\circ}\text{C}$ unless otherwise specified

Parameter	Symbol	Test Condition	Min	Typ	Max	Unit	
Off characteristics							
Drain-source breakdown voltage	$V_{(BR)DSS}$	$V_{GS} = 0V, I_D = 250\mu A$	60	-	-	V	
Zero gate voltage drain current	I_{DSS}	$V_{DS}=60V, V_{GS}=0V$	$T_J=25^{\circ}\text{C}$	-	-	1.0	μA
			$T_J=125^{\circ}\text{C}$	-	-	100	
Gate-body leakage current	I_{GSS}	$V_{DS} = 0V, V_{GS} = \pm 20V$	-	-	± 100	nA	
On characteristics ^③							
Gate-threshold voltage	$V_{GS(th)}$	$V_{DS} = V_{GS}, I_D = 250\mu A$	1.2	1.7	2.5	V	
Static drain-source on-resistance	$R_{DS(on)}$	$V_{GS} = 10V, I_D = 3A$	-	38	48	m Ω	
		$V_{GS} = 4.5V, I_D = 3A$	-	40	50	m Ω	
Forward transconductance	g_{FS}	$V_{DS} = 15V, I_D = 2A$	-	4.6	-	S	
Dynamic characteristics ^④							
Input capacitance	C_{iss}	$V_{DS} = 30V, V_{GS} = 0V, f = 1\text{MHz}$	-	957	-	pF	
Output capacitance	C_{oss}		-	58	-		
Reverse transfer capacitance	C_{rss}		-	46	-		
Gate resistance	R_g	$f = 1\text{MHz}$	-	4.6	-	Ω	
Switching characteristics ^④							
Total gate charge	Q_g	$V_{DS} = 30V, V_{GS} = 4.5V, I_D = 3A$	-	10	-	nC	
Gate-source charge	Q_{gs}		-	2.2	-		
Gate-drain charge	Q_{gd}		-	4.5	-		
Turn-on delay time	$t_{d(on)}$	$V_{DD} = 30V, V_{GS} = 10V, R_G = 1.0\Omega, I_D = 1.5A$	-	3.8	-	ns	
Turn-on rise time	t_r		-	2.9	-		
Turn-off delay time	$t_{d(off)}$		-	20	-		
Turn-off fall time	t_f		-	2.5	-		
Drain-Source Diode Characteristics							
Drain-source diode forward voltage	V_{SD} ^③	$V_{GS} = 0V, I_S = 3A$	-	-	1.4	V	
Maximum continuous drain-source diode forward current	I_S ^①		-	-	3	A	
Maximum pulsed drain-source diode forward current	I_{SM} ^{①②}		-	-	12	A	

Notes :

- $T_A=25^{\circ}\text{C}$.
- $P_W \leq 10\mu s$, Duty cycle $\leq 1\%$.
- Pulse Test : Pulse Width $\leq 300\mu s$, duty cycle $\leq 2\%$.
- Guaranteed by design, not subject to production.
- Device mounted on 1 in² FR-4 board with 2oz. single-sided Copper, in a still air environment with $T_A=25^{\circ}\text{C}$.

Typical Characteristics ($T_J = 25^\circ\text{C}$, unless otherwise specified)

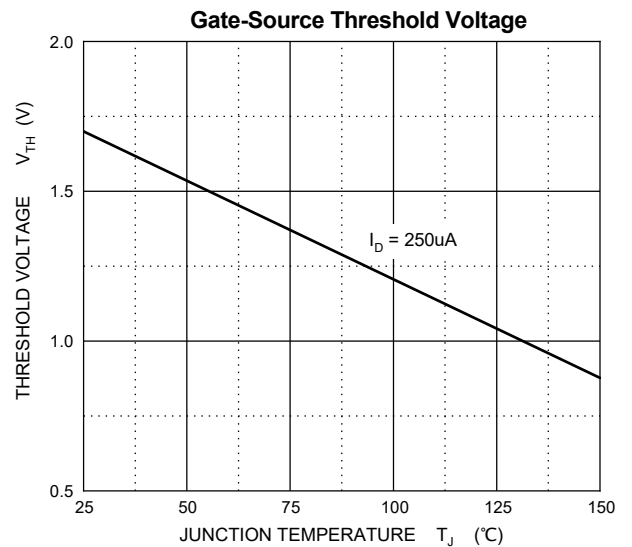
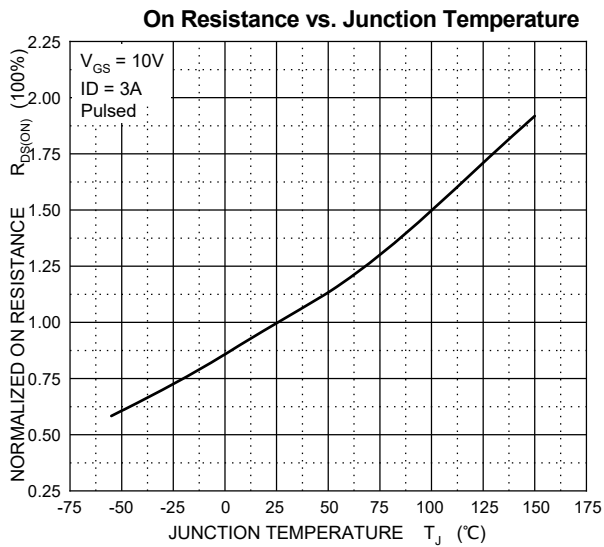
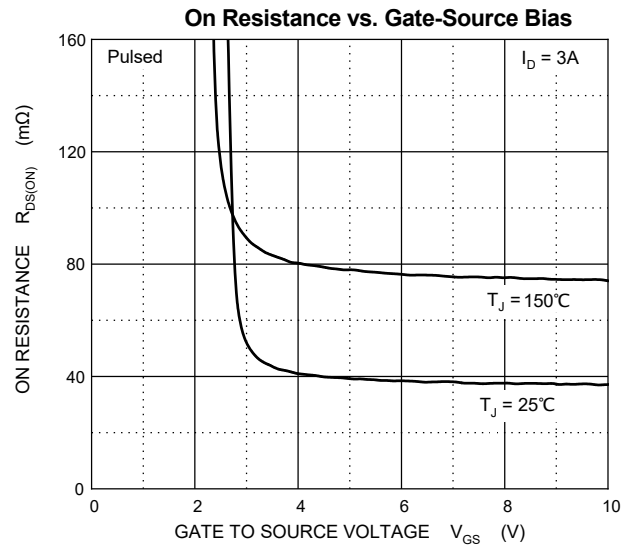
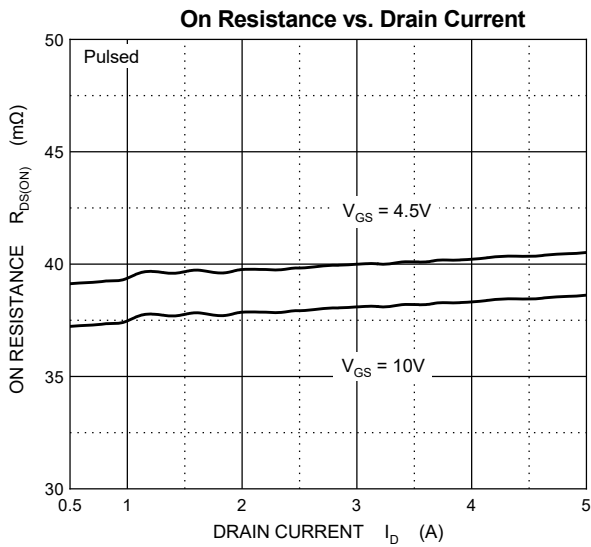
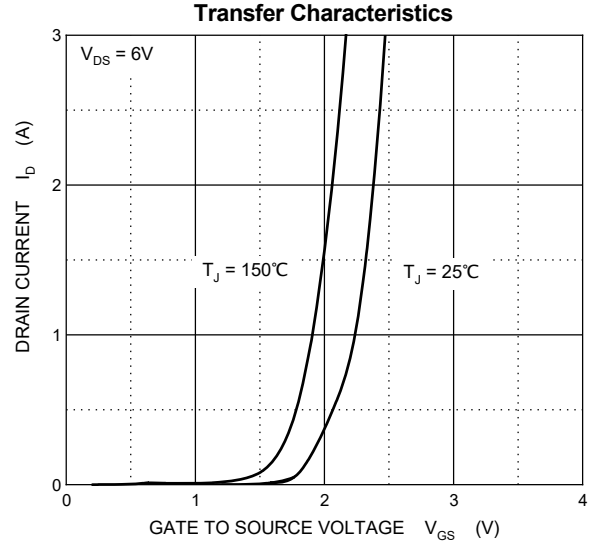
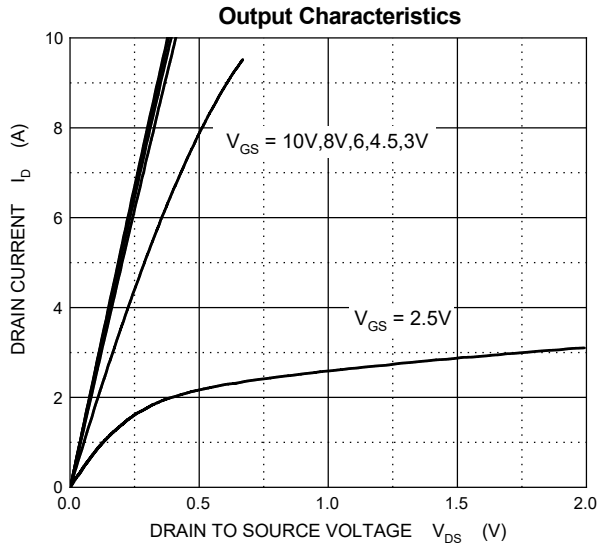

Typical Characteristics (T_J = 25°C, unless otherwise specified)

Typical Capacitances

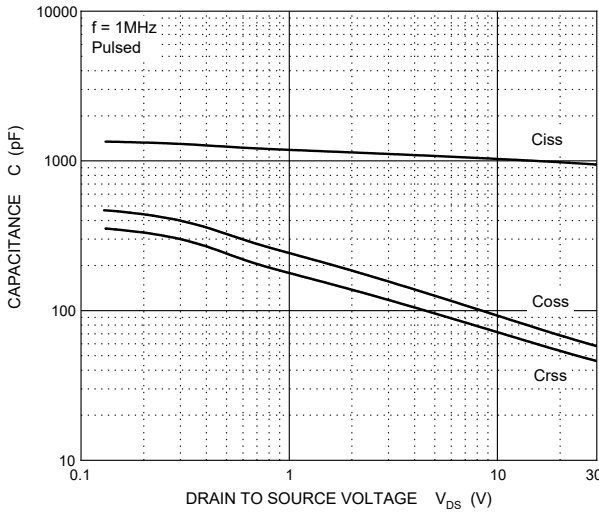

Gate Charge

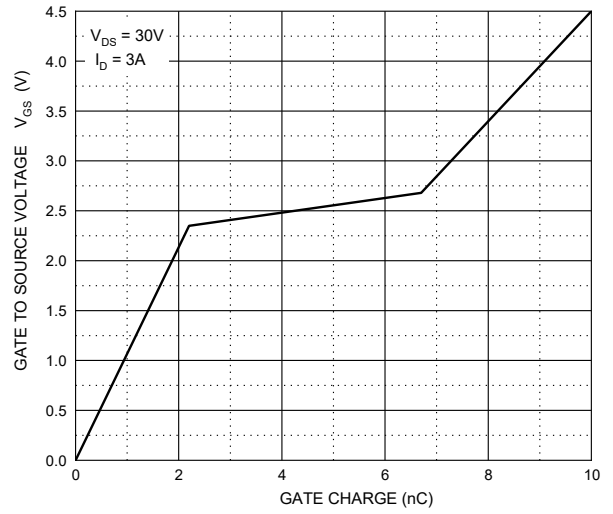

Source-Drain Diode Forward Characteristics

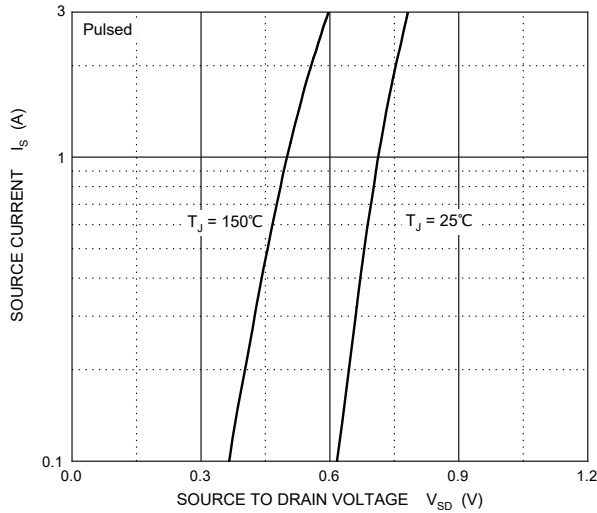

Maximum Safe Operating Area

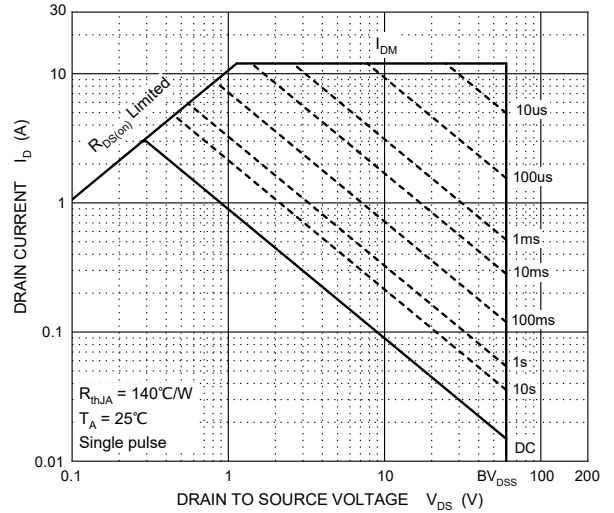

Transient Thermal Impedance, Junction-Ambient

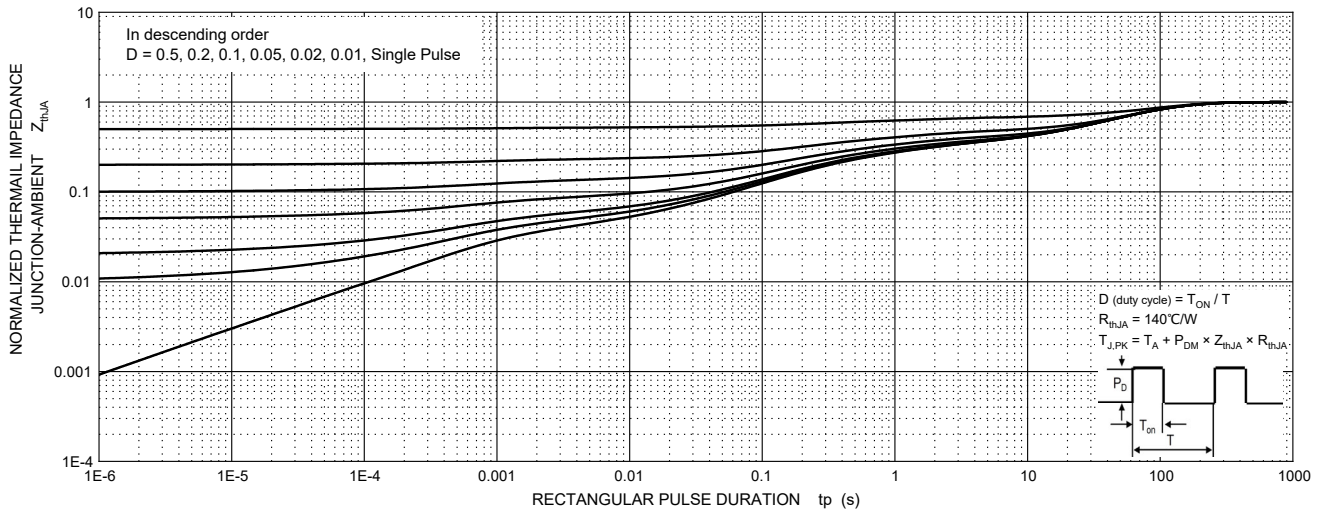

SOT-89-3L Package Outline Dimensions

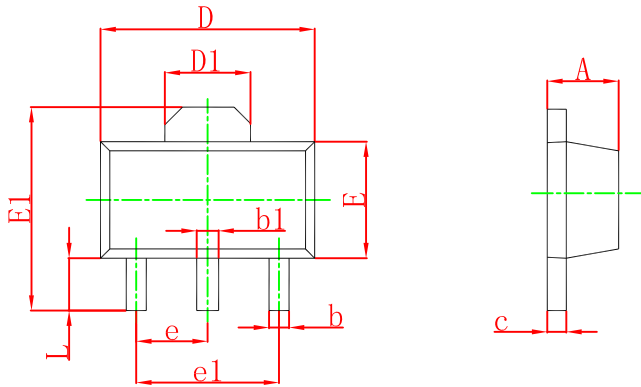

Symbol	Dimensions In Millimeters		Dimensions In Inches	
	Min	Max	Min	Max
A	1.400	1.600	0.055	0.063
b	0.320	0.520	0.013	0.020
b1	0.400	0.580	0.016	0.023
c	0.350	0.440	0.014	0.017
D	4.400	4.600	0.173	0.181
D1	1.550 REF.		0.061 REF.	
E	2.300	2.600	0.091	0.102
E1	3.940	4.250	0.155	0.167
e	1.500 TYP.		0.060 TYP.	
e1	3.000 TYP.		0.118 TYP.	
L	0.900	1.200	0.035	0.047

SOT-89-3L Suggested Pad Layout

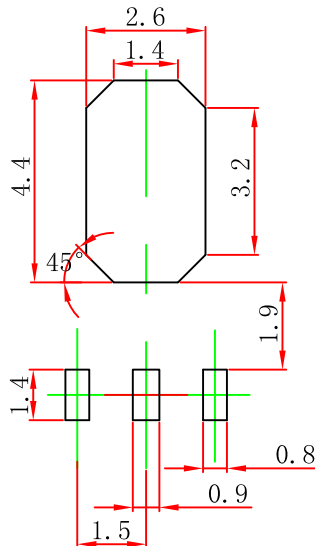

Note:

1. Controlling dimension: in millimeters.
2. General tolerance: ± 0.05 mm.
3. The pad layout is for reference purposes only.

NOTICE

JCET reserves the right to make modifications, enhancements, improvements, corrections or other changes without further notice to any product herein. JCET does not assume any liability arising out of the application or use of any product described herein.

SOT-89-3L Tape and Reel

SOT-89-3L Embossed Carrier Tape

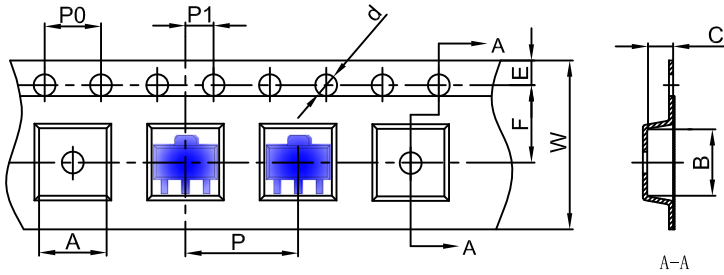

Packaging Description:

SOT-89-3L parts are shipped in tape. The carrier tape is made from a dissipative (carbon filled) polycarbonate resin. The cover tape is a multilayer film (Heat Activated Adhesive in nature) primarily composed of polyester film, adhesive layer, sealant, and anti-static sprayed agent. These reeled parts in standard option are shipped with 1,000 units per 7" or 18.0 cm diameter reel. The reels are clear in color and is made of polystyrene plastic (anti-static coated).

Dimensions are in millimeter										
Pkg type	A	B	C	d	E	F	P0	P	P1	W
SOT-89-3L	4.85	4.45	1.85	Ø1.50	1.75	5.50	4.00	8.00	2.00	12.00

SOT-89-3L Tape Leader and Trailer

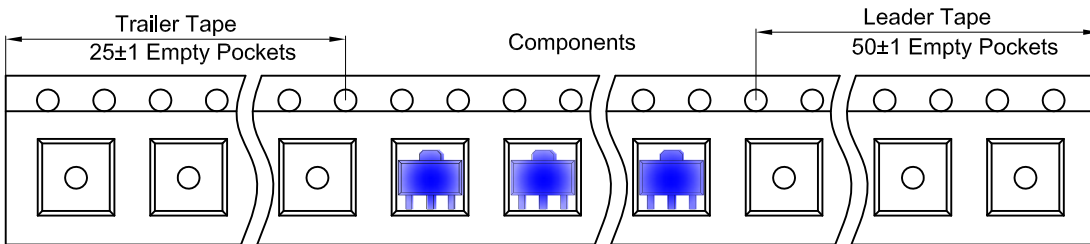

SOT-89-3L Reel

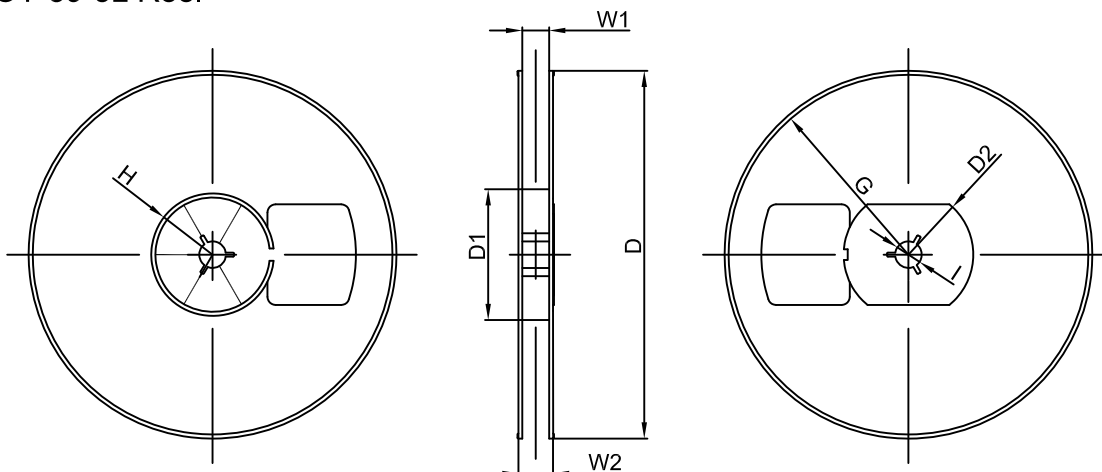

Dimensions are in millimeter								
Reel Option	D	D1	D2	G	H	I	W1	W2
7" Dia	Ø180.00	60.00	R32.00	R86.50	R30.00	Ø13.00	13.20	16.50

REEL	Reel Size	Box	Box Size(mm)	Carton	Carton Size(mm)	G.W.(kg)
1000 pcs	7 inch	10,000 pcs	203×203×195	40,000 pcs	438×438×220	