

CJAB35N03 N-Channel Power MOSFET

$V_{(BR)DSS}$	$R_{DS(on)TYP}$	I_D
30V	5.5mΩ@10V	35A
	8.5mΩ@4.5V	

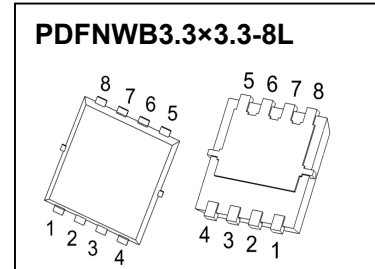

DESCRIPTION

The CJAB35N03 uses advanced trench technology and design to provide excellent $R_{DS(ON)}$ with low gate charge. It can be used in a wide variety of applications

FEATURES

- High density cell design for ultra low $R_{DS(ON)}$
- Fully characterized avalanche voltage and current
- Good stability and uniformity with high E_{AS}
- Excellent package for good heat dissipation

APPLICATIONS

- High side switch in POL DC/DC converter
- Secondary side synchronous rectifier

MARKING

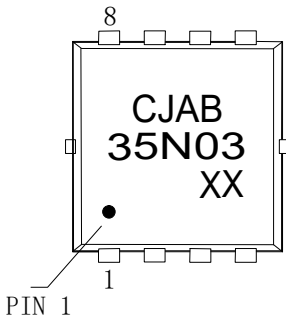

CJAB35N03 = Part No.
Solid dot = Pin1 indicator.
XX = Code.

EQUIVALENT CIRCUIT

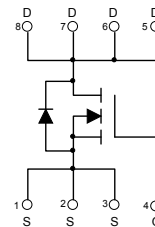

ABSOLUTE MAXIMUM RATINGS ($T_a=25^{\circ}C$ unless otherwise noted)

Parameter	Symbol	Value	Unit
Drain-Source Voltage	V_{DS}	30	V
Gate-Source Voltage	V_{GS}	±20	V
Continuous Drain Current	$I_D^{(1)}$	35	A
Pulsed Drain Current	$I_{DM}^{(2)}$	120	A
Single Pulsed Avalanche Energy	$E_{AS}^{(3)}$	80	mJ
Maximum Power Dissipation	$P_D^{(1)}$	25	W
Thermal Resistance from Junction to Ambient	$R_{\theta JA}^{(6)}$	83.3	$^{\circ}C/W$
Thermal Resistance from Junction to Case	$R_{\theta JC}^{(1)}$	5	$^{\circ}C/W$
Operating Junction and Storage Temperature Range	T_J, T_{stg}	-55~+150	$^{\circ}C$

MOSFET ELECTRICAL CHARACTERISTICS

$T_a=25\text{ }^\circ\text{C}$ unless otherwise specified

Parameter	Symbol	Test Condition	Min	Typ	Max	Unit
Off characteristics						
Drain-source breakdown voltage	$V_{(BR)DSS}$	$V_{GS} = 0V, I_D = 250\mu A$	30			V
Zero gate voltage drain current	I_{DSS}	$V_{DS} = 24V, V_{GS} = 0V$	$T_J = 25\text{ }^\circ\text{C}$		1.0	μA
			$T_J = 125\text{ }^\circ\text{C}$		100	
Gate-body leakage current	I_{GSS}	$V_{DS} = 0V, V_{GS} = \pm 20V$			± 100	nA
On characteristics ④						
Gate-threshold voltage	$V_{GS(th)}$	$V_{DS} = V_{GS}, I_D = 250\mu A$	1.0	1.5	3.0	V
Static drain-source on-state resistance	$R_{DS(on)}$	$V_{GS} = 10V, I_D = 12A$		5.5	7.0	m Ω
		$V_{GS} = 4.5V, I_D = 10A$		8.5	12	m Ω
Dynamic characteristics ④ ⑤						
Input capacitance	C_{iss}	$V_{DS} = 15V, V_{GS} = 0V, f = 1MHz$		1300	2600	μF
Output capacitance	C_{oss}			230	460	
Reverse transfer capacitance	C_{rss}			228	456	
Gate resistance	R_g	$f = 1MHz$		1.7		Ω
Switching characteristics ④ ⑤						
Total gate charge	Q_g	$V_{GS} = 10V, V_{DS} = 15V, I_D = 12A$		40	80	nC
Gate-source charge	Q_{gs}			5.1	10.2	
Gate-drain charge	Q_{gd}			9.1	18.2	
Turn-on delay time	$t_{d(on)}$	$V_{DS} = 15V, I_D = 12A, V_{GS} = 10V, R_G = 6\Omega$		9.0	18	ns
Turn-on rise time	t_r			26	50	
Turn-off delay time	$t_{d(off)}$			35	70	
Turn-off fall time	t_f			8.0	16	
Drain-Source Diode Characteristics						
Drain-source diode forward voltage	V_{SD} ④	$V_{GS} = 0V, I_S = 12A$			1.2	V
Continuous drain-source diode forward current	I_S ①				35	A
Pulsed drain-source diode forward current	I_{SM} ②				120	A

Notes:

- $T_c=25\text{ }^\circ\text{C}$ Limited only by maximum temperature allowed.
- $P_w \leq 10\mu s$, Duty cycle $\leq 1\%$.
- EAS condition: $V_{DD} = 15V, V_{GS} = 10V, L = 0.1mH, R_g = 25\Omega$ Starting $T_J = 25\text{ }^\circ\text{C}$.
- Pulse Test : Pulse Width $\leq 300\mu s$, duty cycle $\leq 2\%$.
- Guaranteed by design, not subject to production.
- The value of $R_{\theta JA}$ is measured with the device mounted on 1 in 2 FR-4 board with 2oz. Copper, in a still air environment with $T_a = 25\text{ }^\circ\text{C}$.

Typical Characteristics

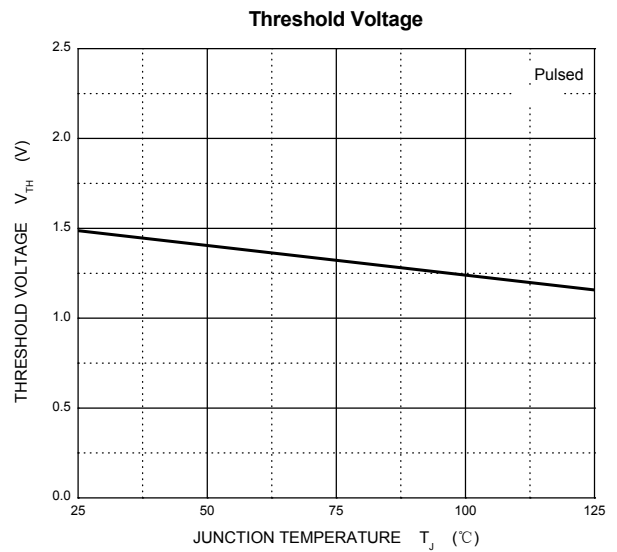
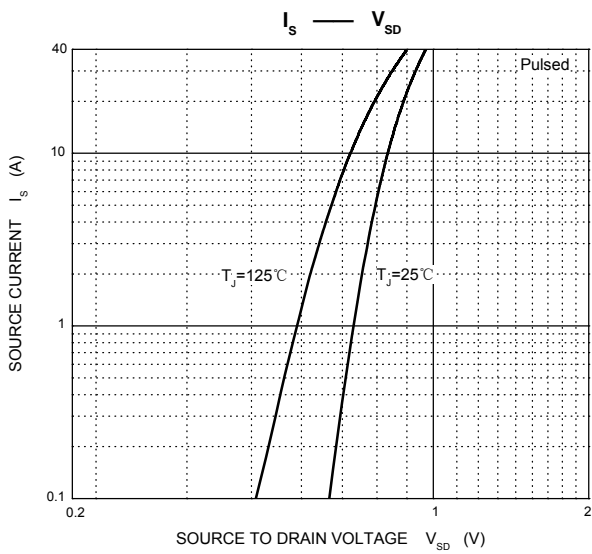
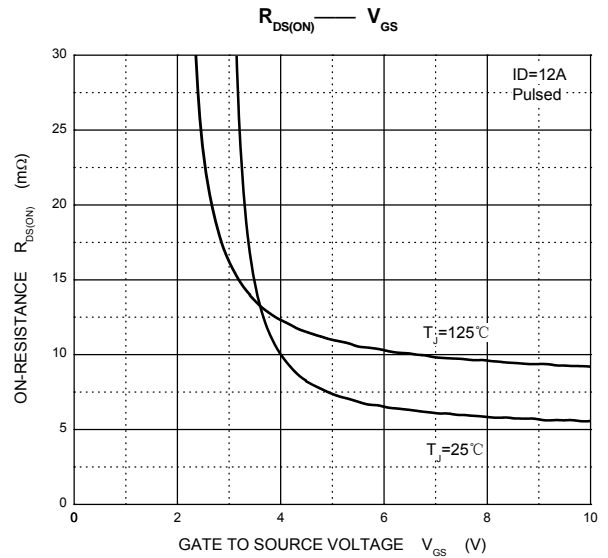
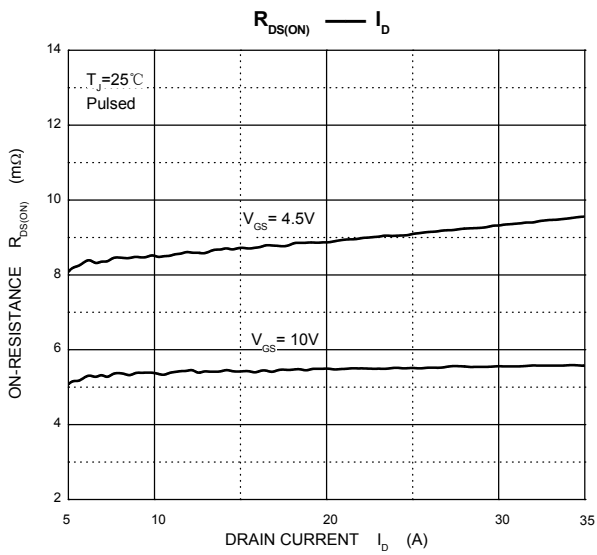
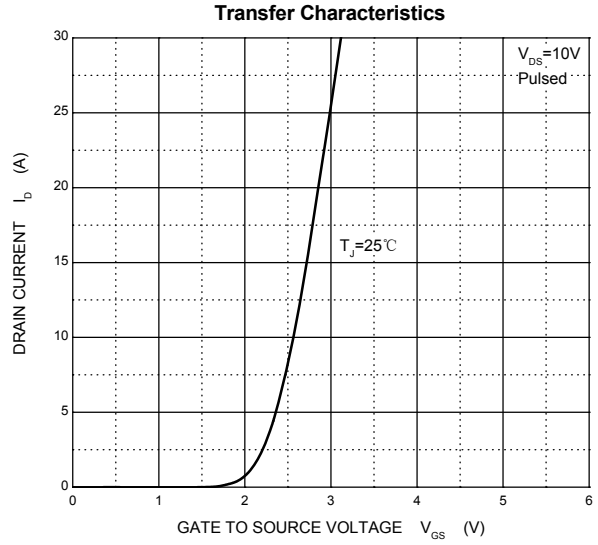
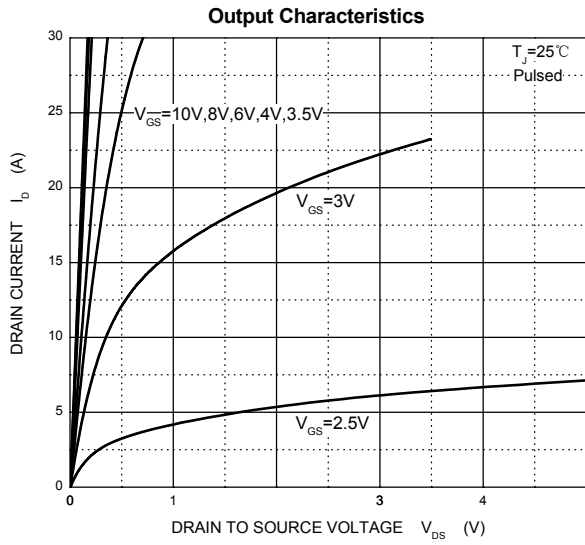

Typical Characteristics

Capacitances

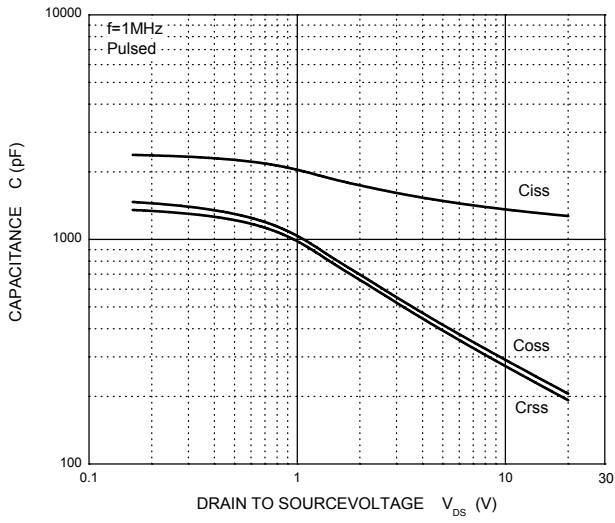

Gate Charge

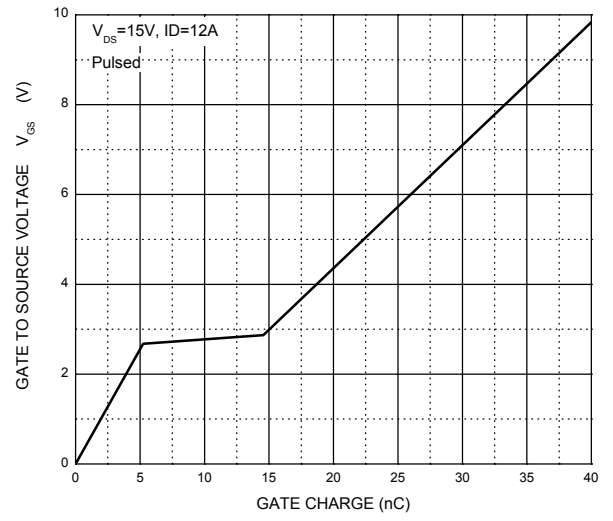

PDFNWB3.3×3.3-8L PACKAGE OUTLINE DIMENSIONS

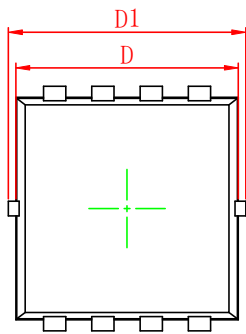

Top View
[顶视图]

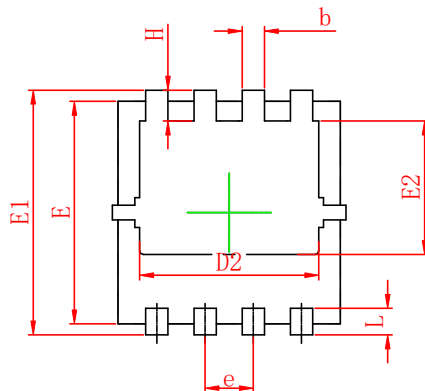

Bottom View
[背视图]

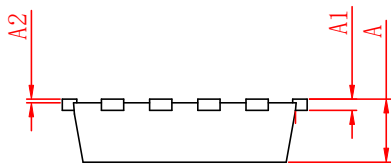

Side View
[侧视图]

Symbol	Dimensions In Millimeters		Dimensions In Inches	
	Min.	Max.	Min.	Max.
A	0.65	0.90	0.026	0.035
A1	0.15 REF.		0.006 REF.	
A2	0~0.05		0~0.002	
D	2.90	3.20	0.114	0.126
D1	3.00	3.40	0.118	0.134
D2	2.30	2.70	0.091	0.106
E	2.90	3.20	0.114	0.126
E1	3.00	3.40	0.118	0.134
E2	1.60	1.90	0.063	0.075
b	0.20	0.42	0.008	0.017
e	0.65 BSC.		0.026 BSC.	
L	0.20	0.50	0.008	0.020
H	0.32	0.52	0.012	0.020

Notes:

- 1 Dimensions exclusive of mold gate burrs.
- 2 Dimensions exclusive of mold flash and cutting burrs.

PDFNWB3.3×3.3-8L Suggested Pad Layout

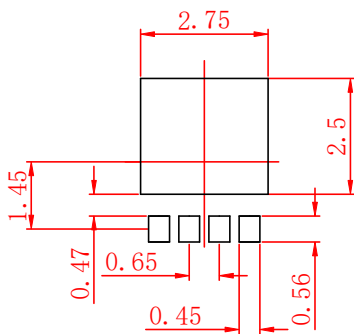

Notes:

- 1 Controlling dimension: in millimeters.
- 2 General tolerance: ±0.05mm.
- 2 The pad layout is for reference purpose only.

NOTICE

JSCJ reserves the right to make modifications, enhancements, improvements, corrections or other changes without further notice to any product herein. JSCJ does not assume any liability arising out of the application or use of any product described herein.

PDFNWB3.3×3.3-8L Tape and Reel

PDFNWB3.3×3.3-8L Embossed Carrier Tape



Packaging Description:

PDFNWB3.3×3.3-8L parts are shipped in tape. The carrier tape is made from a dissipative (carbon filled) polycarbonate resin. The cover tape is a multilayer film (Heat Activated Adhesive in nature) primarily composed of polyester film, adhesive layer, sealant, and anti-static sprayed agent. These reeled parts in standard option are shipped with 5,000 units per 13" or 33.0 cm diameter reel. The reels are clear in color and is made of polystyrene plastic (anti-static coated).

Dimensions are in millimeter

Pkg type	A	B	C	d	E	F	P0	P	P1	W
PDFNWB3.3×3.3-8L	3.55	3.55	1.10	Ø1.50	1.75	5.50	4.00	8.00	2.00	12.00

PDFNWB3.3×3.3-8L Tape Leader and Trailer

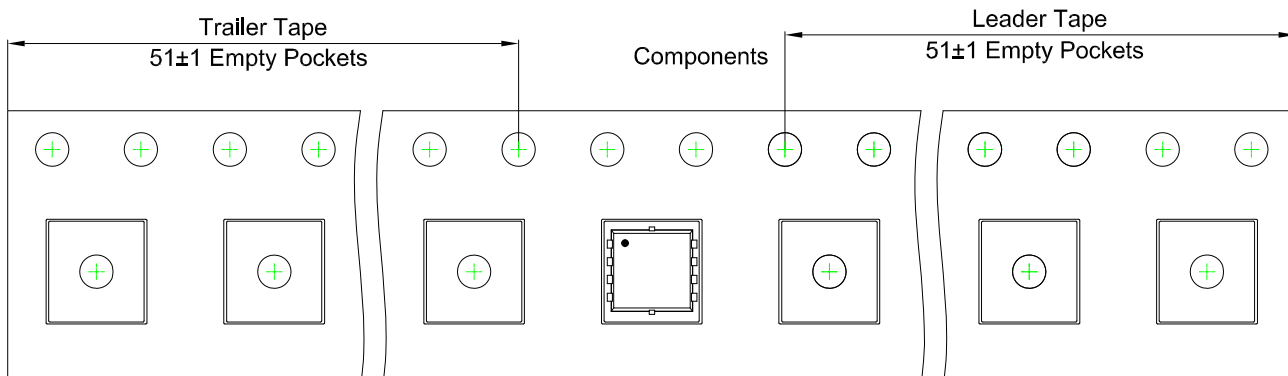

PDFNWB3.3×3.3-8L Reel

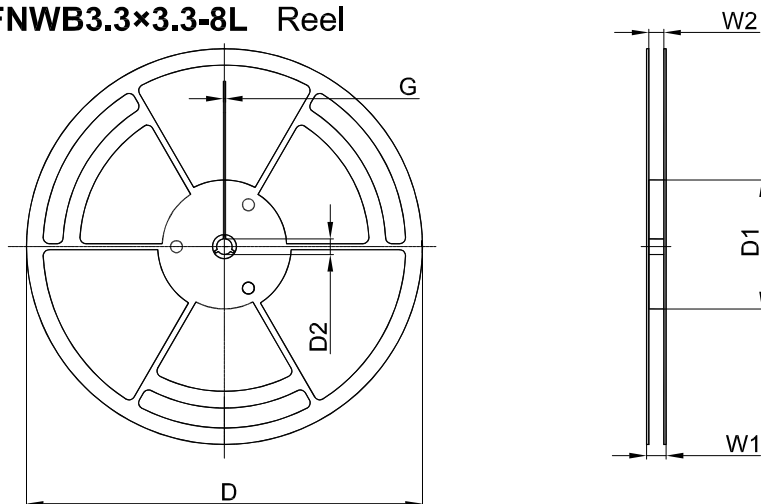

Dimensions are in millimeter

Reel Option	D	D1	D2	G	W1	W2
13" Dia	φ330.00	100.00	13.00	1.90	17.60	12.40

Reel	Reel Size	Box	Box Size (mm)	Carton	Carton Size (mm)
5,000 pcs	13 inch	10,000 pcs	360×360×65	50,000 pcs	378×358×382