

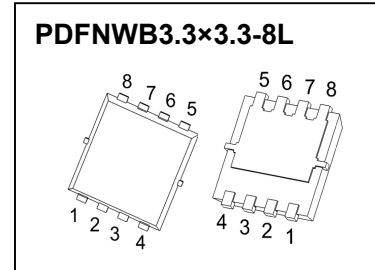

**PDFNWB3.3×3.3-8L Plastic-Encapsulate MOSFETS**

**CJAB35P03 P-Channel Power MOSFET**

<b>V<sub>(BR)DSS</sub></b>	<b>R<sub>DS(on)MAX</sub></b>	<b>I<sub>D</sub></b>
-30V	15mΩ@-10V	-35A



**DESCRIPTION**

The CJAB35P03 uses advanced trench technology and design to provide excellent R<sub>DS(ON)</sub> with low gate charge. It can be used in a wide variety of applications

**FEATURES**

- High density cell design for ultra low R<sub>DS(ON)</sub>
- Fully characterized avalanche voltage and current
- Good stability and uniformity with high E<sub>AS</sub>
- Excellent package for good heat dissipation
- Special process technology for high ESD capability

**APPLICATIONS**

- Battery and loading switching

**MARKING**

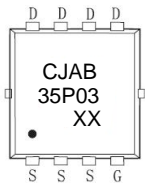

CJAB35P03 = Part No.  
 Solid dot=Pin1 indicator  
 XX=Date Code

**EQUIVALENT CIRCUIT**

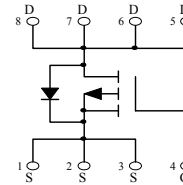

**ABSOLUTE MAXIMUM RATINGS (T<sub>a</sub>=25°C unless otherwise noted)**

Parameter	Symbol	Value	Unit
Drain-Source Voltage	V <sub>DS</sub>	-30	V
Gate-Source Voltage	V <sub>GS</sub>	±20	V
Continuous Drain Current	I <sub>D</sub> <sup>①</sup>	-35	A
Pulsed Drain Current	I <sub>DM</sub> <sup>②</sup>	-140	A
Single Pulsed Avalanche Energy	E <sub>AS</sub> <sup>③</sup>	190	mJ
Power Dissipation	P <sub>D</sub> <sup>①</sup>	30	W
Thermal Resistance from Junction to Case	R <sub>θJC</sub> <sup>①</sup>	4.17	°C/W
Thermal Resistance from Junction to Ambient	R <sub>θJA</sub> <sup>⑥</sup>	83.3	°C/W
Operating Junction and Storage Temperature Range	T <sub>J</sub> , T <sub>stg</sub>	-55~+150	°C

# MOSFET ELECTRICAL CHARACTERISTICS

$T_a=25^\circ\text{C}$  unless otherwise specified

Parameter	Symbol	Test Condition	Min	Type	Max	Unit
<b>Static Characteristics</b>						
Drain-source breakdown voltage	$V_{(BR)DSS}$	$V_{GS} = 0V, I_D = 250\mu A$	-30			V
Zero gate voltage drain current	$I_{DSS}$	$V_{DS} = -24V, V_{GS} = 0V$			-1	$\mu A$
Gate-body leakage current	$I_{GSS}$	$V_{GS} = \pm 20V, V_{DS} = 0V$			$\pm 100$	nA
Gate threshold voltage	$V_{GS(th)}$	$V_{DS} = V_{GS}, I_D = 250\mu A$	-1.0	-1.6	-2.5	V
Drain-source on-resistance	$R_{DS(on)}$	$V_{GS} = -10V, I_D = -12A$		9	15	$m\Omega$
		$V_{GS} = -4.5V, I_D = -12A$		14	25	$m\Omega$
<b>Dynamic characteristics</b> <sup>④ ⑤</sup>						
Total gate charge	$Q_g$	$V_{DS} = -15V, V_{GS} = -10V, I_D = -12A$		38		nC
Gate-source charge	$Q_{gs}$			7		
Gate-drain charge	$Q_{gd}$			9		
Input Capacitance	$C_{iss}$	$V_{DS} = -15V, V_{GS} = 0V, f = 1MHz$		2280		pF
Output Capacitance	$C_{oss}$			385		
Reverse Transfer Capacitance	$C_{rss}$			278		
<b>SWITCHING PARAMETERS</b> <sup>④ ⑤</sup>						
Turn-on delay time	$t_{d(on)}$	$V_{DS} = -15V, I_D = -1A,$ $V_{GS} = -10V, R_g = 2.5\Omega$		10		ns
Turn-on rise time	$t_r$			22		
Turn-off delay time	$t_{d(off)}$			36		
Turn-off fall time	$t_f$			9		
<b>Source-Drain Diode characteristics</b>						
Body diode voltage	$V_{SD}$ <sup>④</sup>	$I_S = -12A, V_{GS} = 0V$		-0.8	-1.2	V
Continuous drain-source diode forward current	$I_S$				-35	A
Pulsed drain-source diode forward current	$I_{SM}$				-140	A

Notes:

- $T_c=25^\circ\text{C}$  Limited only by maximum temperature allowed.
- $P_w \leq 10\mu s$ , Duty cycle  $\leq 1\%$ .
- EAS condition:  $V_{DD} = -25V, V_{GS} = -10V, L = 0.5mH, R_g = 25\Omega$  Starting  $T_j = 25^\circ\text{C}$ .
- Pulse Test : Pulse Width  $\leq 300\mu s$ , duty cycle  $\leq 2\%$ .
- Guaranteed by design, not subject to production.
- The value of  $R_{\theta JA}$  is measured with the device mounted on 1 in 2 FR-4 board with 2oz. Copper, in a still air environment with  $T_a = 25^\circ\text{C}$ .

# Typical Characteristics

**Output Characteristics**

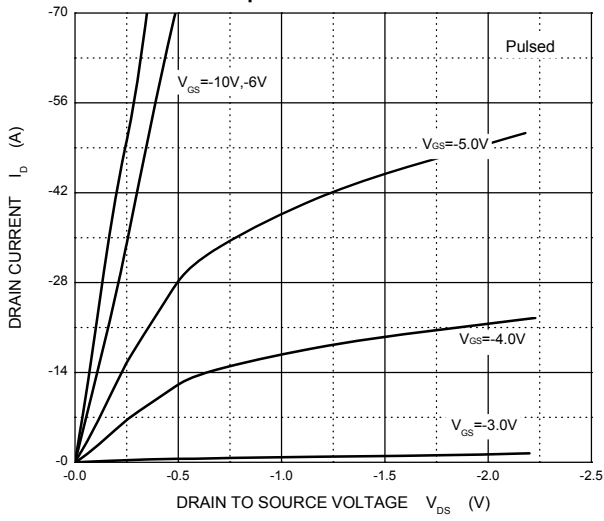

**Transfer Characteristics**

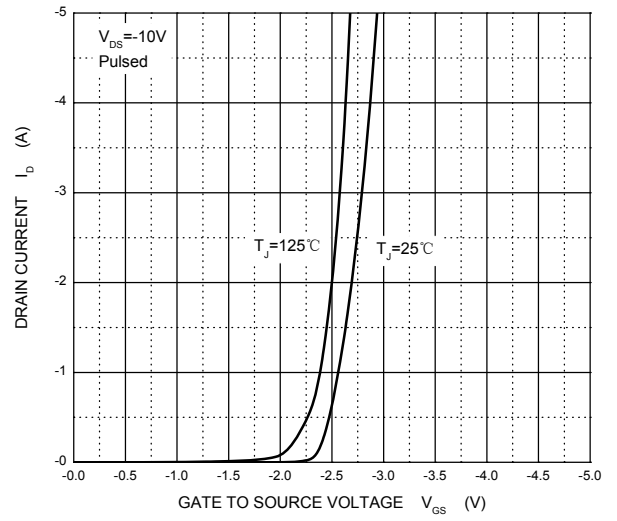

**$R_{DS(ON)}$  —  $I_D$**

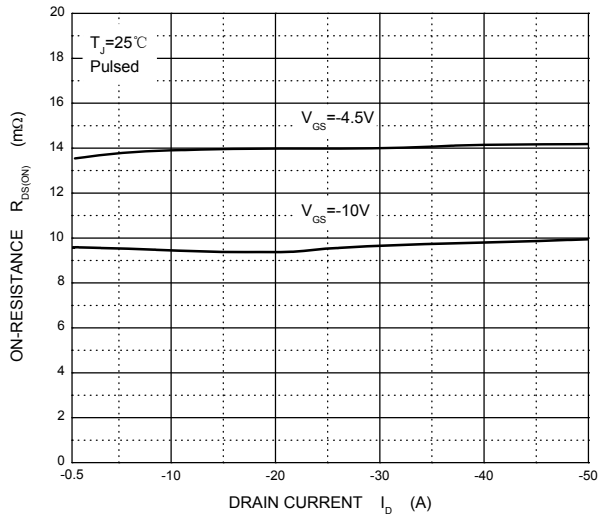

**$R_{DS(ON)}$  —  $V_{GS}$**

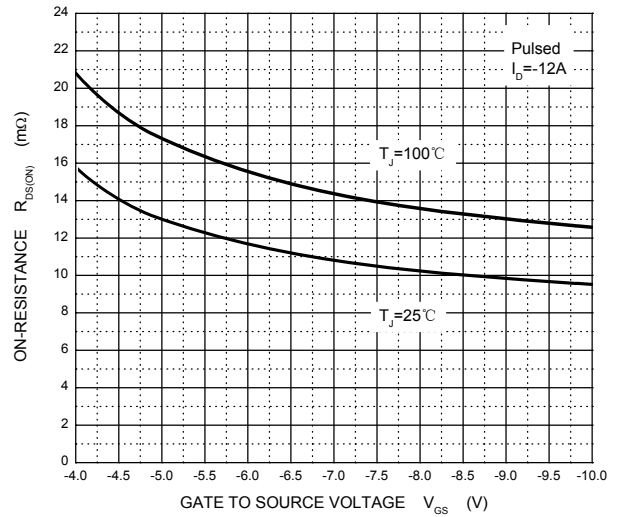

**$I_S$  —  $V_{SD}$**

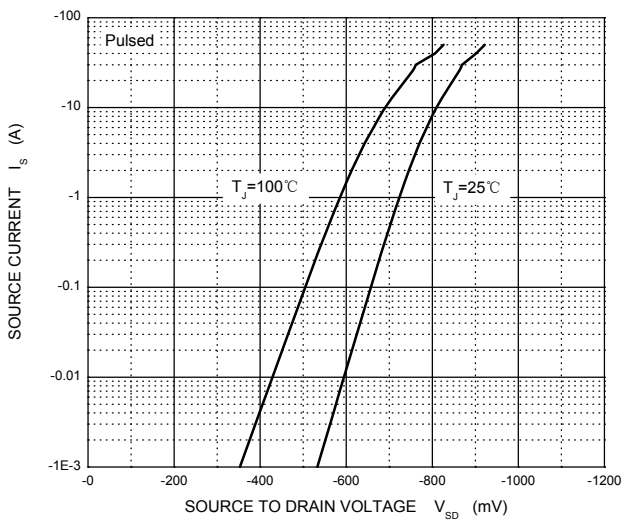

**Threshold Voltage**

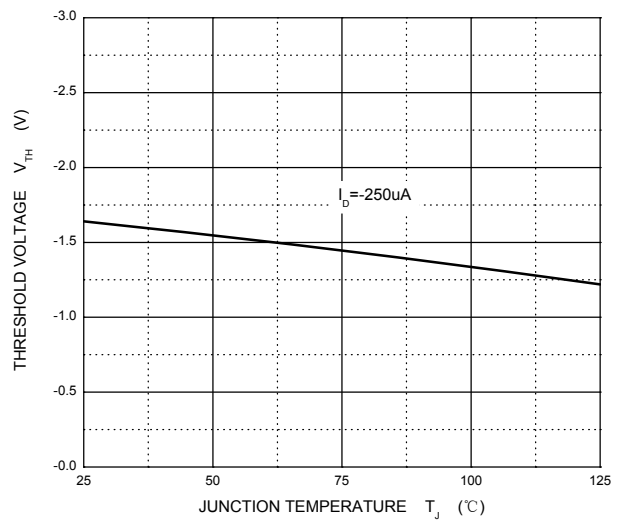

# Typical Characteristics

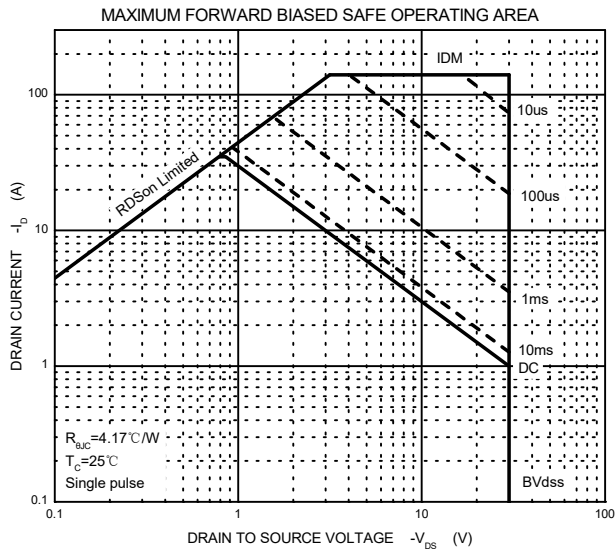
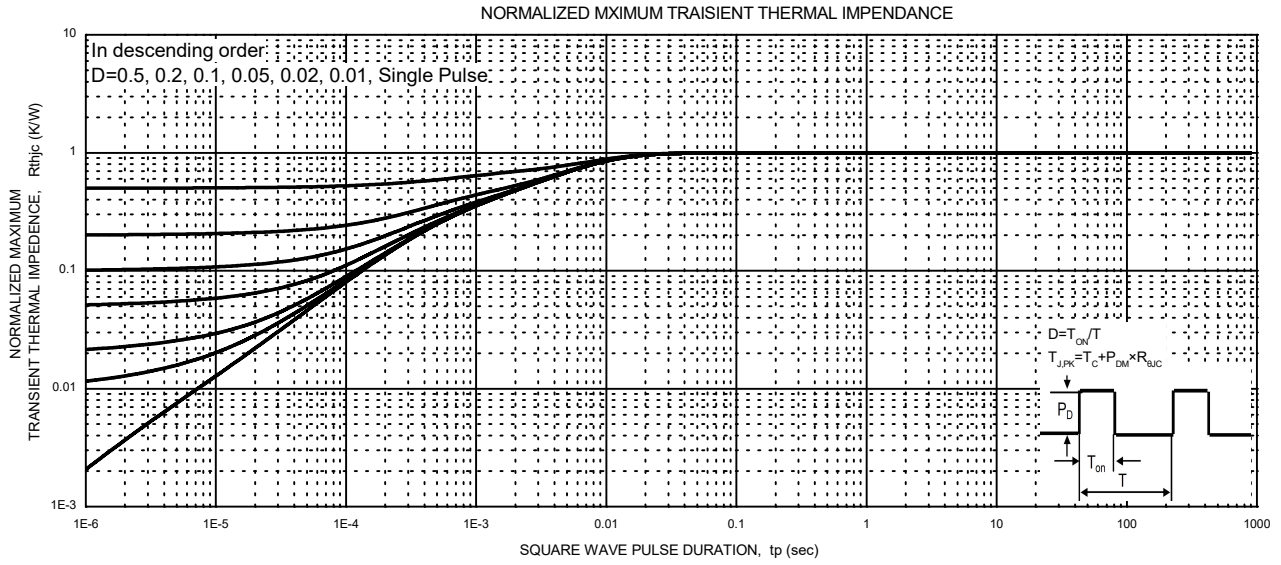

# PDFNWB3.3×3.3-8L PACKAGE OUTLINE DIMENSIONS

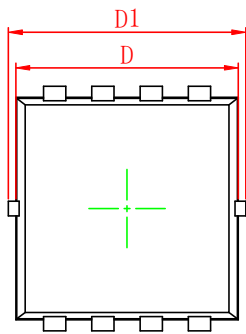

Top View  
[顶视图]

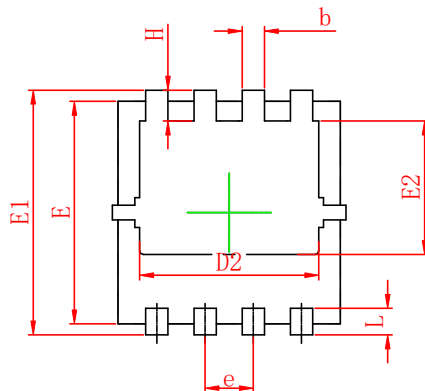

Bottom View  
[背视图]

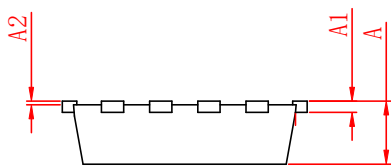

Side View  
[侧视图]

Symbol	Dimensions In Millimeters		Dimensions In Inches	
	Min.	Max.	Min.	Max.
A	0.65	0.90	0.026	0.035
A1	0.15 REF.		0.006 REF.	
A2	0~0.05		0~0.002	
D	2.90	3.20	0.114	0.126
D1	3.00	3.40	0.118	0.134
D2	2.30	2.70	0.091	0.106
E	2.90	3.20	0.114	0.126
E1	3.00	3.40	0.118	0.134
E2	1.60	1.90	0.063	0.075
b	0.20	0.42	0.008	0.017
e	0.65 BSC.		0.026 BSC.	
L	0.20	0.50	0.008	0.020
H	0.32	0.52	0.012	0.020

Notes:

- 1 Dimensions exclusive of mold gate burrs.
- 2 Dimensions exclusive of mold flash and cutting burrs.

## PDFNWB3.3×3.3-8L Suggested Pad Layout

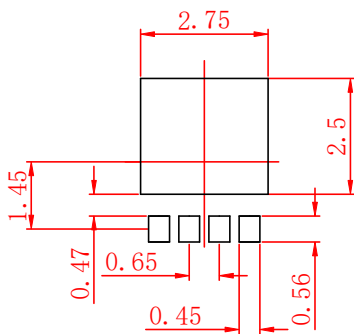

Notes:

- 1 Controlling dimension: in millimeters.
- 2 General tolerance: ±0.05mm.
- 2 The pad layout is for reference purpose only.

NOTICE

JSCJ reserves the right to make modifications, enhancements, improvements, corrections or other changes without further notice to any product herein. JSCJ does not assume any liability arising out of the application or use of any product described herein.

# PDFNWB3.3×3.3-8L Tape and Reel

## PDFNWB3.3×3.3-8L Embossed Carrier Tape



### Packaging Description:

**PDFNWB3.3×3.3-8L** parts are shipped in tape. The carrier tape is made from a dissipative (carbon filled) polycarbonate resin. The cover tape is a multilayer film (Heat Activated Adhesive in nature) primarily composed of polyester film, adhesive layer, sealant, and anti-static sprayed agent. These reeled parts in standard option are shipped with 5,000 units per 13" or 33.0 cm diameter reel. The reels are clear in color and is made of polystyrene plastic (anti-static coated).

Dimensions are in millimeter										
Pkg type	A	B	C	d	E	F	P0	P	P1	W
PDFNWB3.3×3.3-8L	3.55	3.55	1.10	Ø1.50	1.75	5.50	4.00	8.00	2.00	12.00

## PDFNWB3.3×3.3-8L Tape Leader and Trailer

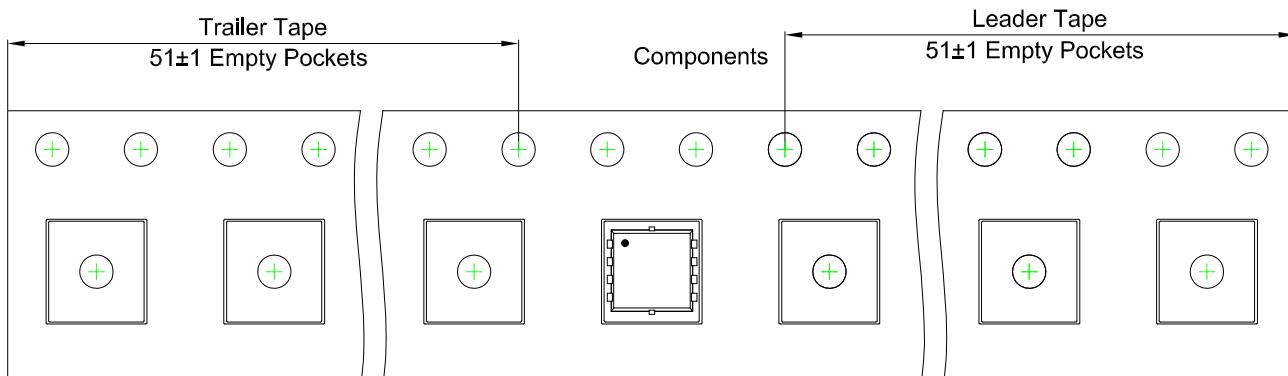

## PDFNWB3.3×3.3-8L Reel

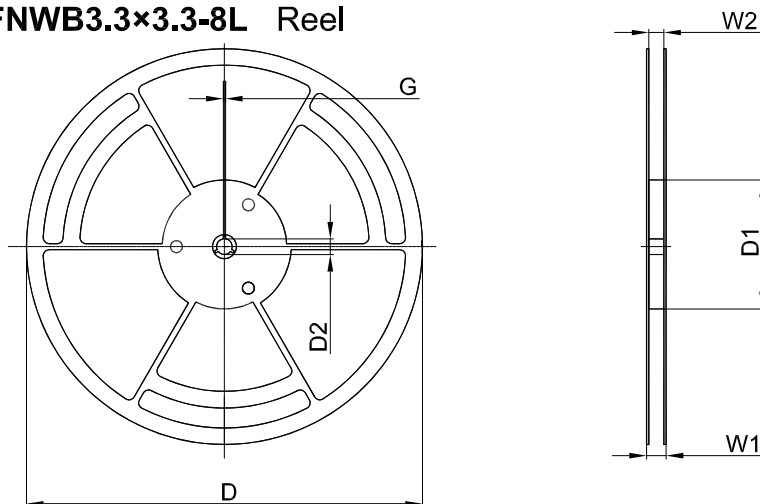

Dimensions are in millimeter						
Reel Option	D	D1	D2	G	W1	W2
13" Dia	φ330.00	100.00	13.00	1.90	17.60	12.40

Reel	Reel Size	Box	Box Size (mm)	Carton	Carton Size (mm)
5,000 pcs	13 inch	10,000 pcs	360×360×65	50,000 pcs	378×358×382