

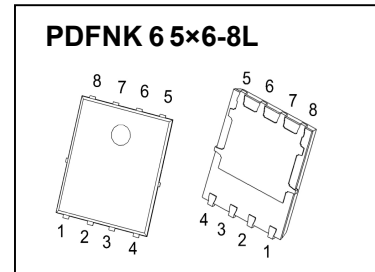

PDFNK 6 5×6-8L Plastic-Encapsulate MOSFETS

CJAC130SN04L N-Channel Power MOSFET

$V_{(BR)DSS}$	$R_{DS(on)TYP}$	I_D
40V	2.0mΩ@10V	130A



DESCRIPTION

These N-Channel enhancement mode power field effect transistors are using SGT technology. This advanced technology has been especially tailored to minimize on-state resistance, provide superior switching performance, and withstand high energy pulse in the avalanche and commutation mode. These devices are well suited for high efficiency fast switching applications.

FEATURES

- Battery switch
- Load switch
- High density cell design for ultra low $R_{DS(ON)}$
- Good stability and uniformity with high E_{AS}
- Excellent package for good heat dissipation

APPLICATIONS

- Networking
- Load Switch
- LED applications

MARKING

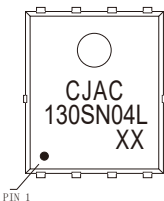

CJAC130SN04L = Part No.
Solid dot=Pin1 indicator.
XX=Code.

EQUIVALENT CIRCUIT

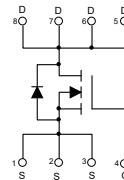

MAXIMUM RATINGS ($T_a=25^\circ\text{C}$ unless otherwise noted)

Parameter	Symbol	Limit	Unit
Drain-Source Voltage	V_{DS}	40	V
Gate-Source Voltage	V_{GS}	±20	V
Continuous Drain Current	$I_D^{(1)}$	130	A
Continuous Drain Current ($T_C=100^\circ\text{C}$)	I_D	90	A
Pulsed Drain Current	$I_{DM}^{(2)}$	390	A
Single Pulsed Avalanche Energy	$E_{AS}^{(3)}$	300	mJ
Power Dissipation	$P_D^{(1)}$	120	W
Thermal Resistance from Junction to Ambient	$R_{\theta JA}^{(6)}$	62.5	$^\circ\text{C/W}$
Thermal Resistance from Junction to Case	$R_{\theta JC}^{(1)}$	1.04	$^\circ\text{C/W}$
Operating Junction and Storage Temperature Range	T_J, T_{stg}	-55~+150	$^\circ\text{C}$

MOSFET ELECTRICAL CHARACTERISTICS

$T_a=25^\circ\text{C}$ unless otherwise specified

Parameter	Symbol	Test Condition	Min	Typ	Max	Unit	
Off characteristics							
Drain-source breakdown voltage	$V_{(BR)DSS}$	$V_{GS} = 0V, I_D = 250\mu A$	40	-	-	V	
Zero gate voltage drain current	I_{DSS}	$V_{DS} = 32V, V_{GS} = 0V$	$T_J = 25^\circ\text{C}$	-	-	1.0	μA
			$T_J = 125^\circ\text{C}$	-	-	100	
Gate-body leakage current	I_{GSS}	$V_{DS} = 0V, V_{GS} = \pm 20V$	-	-	± 100	nA	
On characteristics ^④							
Gate-threshold voltage	$V_{GS(th)}$	$V_{DS} = V_{GS}, I_D = 250\mu A$	1.0	1.5	2.0	V	
Static drain-source on-state resistance	$R_{DS(on)}$	$V_{GS} = 10V, I_D = 20A$	-	2.0	2.4	m Ω	
	$R_{DS(on)}$	$V_{GS} = 4.5V, I_D = 20A$	-	2.9	3.7	m Ω	
Forward transconductance	g_{fs}	$V_{DS} = 5V, I_D = 20A$	-	43	-	S	
Dynamic characteristics ^{④ ⑤}							
Input capacitance	C_{iss}	$V_{DS} = 20V, V_{GS} = 0V, f = 1MHz$	-	2620	-	μF	
Output capacitance	C_{oss}		-	690	-		
Reverse transfer capacitance	C_{rss}		-	26	-		
Switching characteristics ^{④ ⑤}							
Total gate charge	Q_g	$V_{GS} = 10V, V_{DS} = 20V, I_D = 70A$	-	47.7	-	nC	
Gate-source charge	Q_{gs}		-	6	-		
Gate-drain charge	Q_{gd}		-	1.2	-		
Turn-on delay time	$t_{d(on)}$	$V_{DS} = 20V, I_D = 35A, V_{GS} = 10V, R_G = 1.6\Omega$	-	8	-	ns	
Turn-on rise time	t_r		-	30	-		
Turn-off delay time	$t_{d(off)}$		-	32	-		
Turn-off fall time	t_f		-	6	-		
Drain-Source Diode Characteristics							
Reverse Recovery Time	t_{rr}	$I_{SD} = 30A, dI_{SD}/dt = 100A/\mu s$	-	47	-	ns	
Reverse Recovery Charge	Q_{rr}		-	35	-	nC	
Drain-source diode forward voltage	V_{SD} ^④	$V_{GS} = 0V, I_S = 10A$	-	-	1.2	V	
Continuous drain-source diode forward current	I_S ^①		-	-	130	A	
Pulsed drain-source diode forward current	I_{SM} ^②		-	-	390	A	

Notes:

1. $T_c = 25^\circ\text{C}$ Limited only by maximum temperature allowed.

2. $PW \leq 10\mu s$, Duty cycle $\leq 1\%$.

3. EAS condition: $V_{DD} = 25V, V_{GS} = 10V, L = 0.5mH, R_g = 25\Omega$ Starting $T_J = 25^\circ\text{C}$.

4. Pulse Test : Pulse Width $\leq 300\mu s$, duty cycle $\leq 2\%$.

5. Guaranteed by design, not subject to production.

6. The value of $R_{\theta JA}$ is measured with the device mounted on 1 in 2 FR-4 board with 2oz. Copper, in a still air environment with $T_a = 25^\circ\text{C}$.

Typical Characteristics

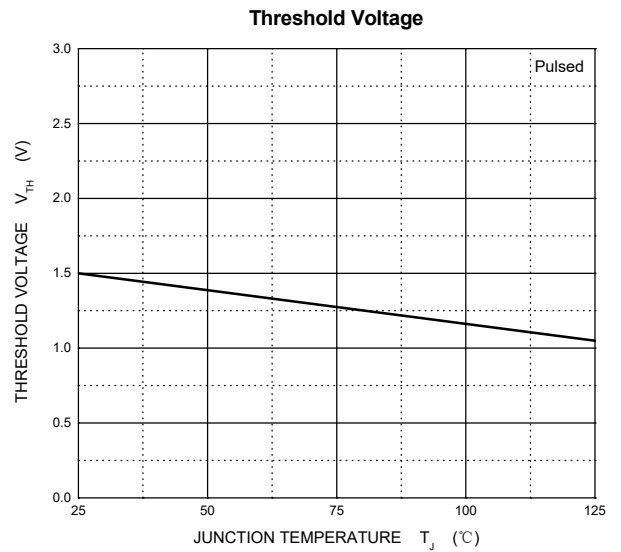
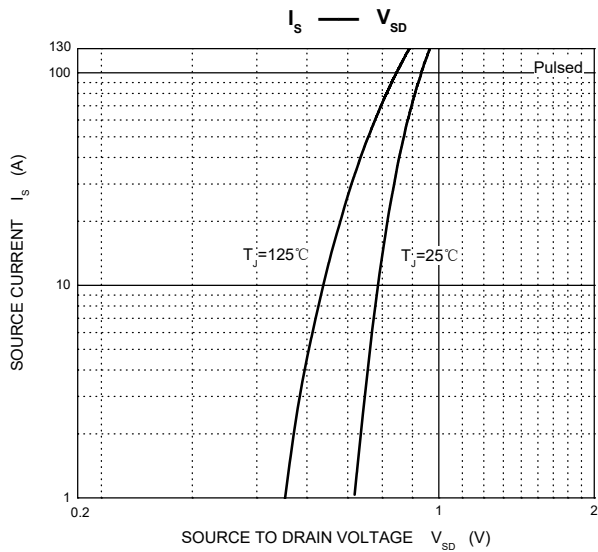
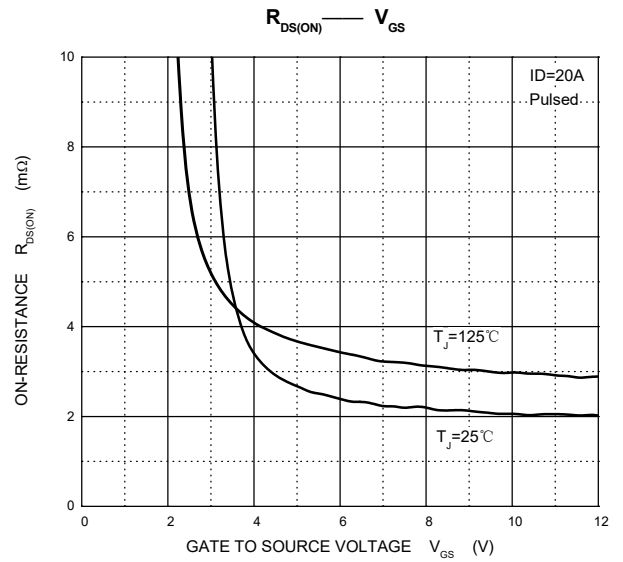
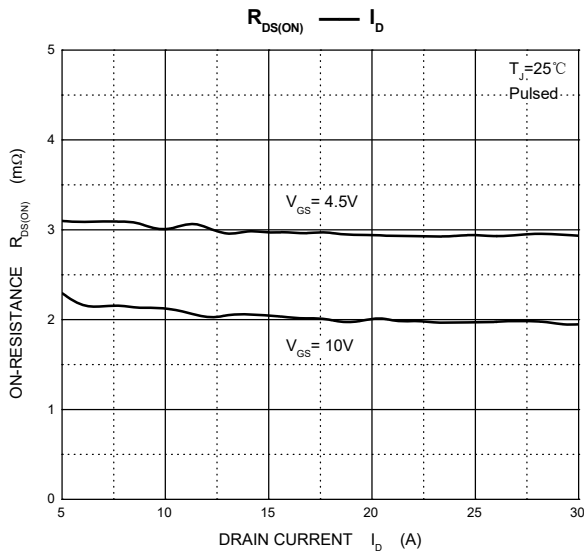
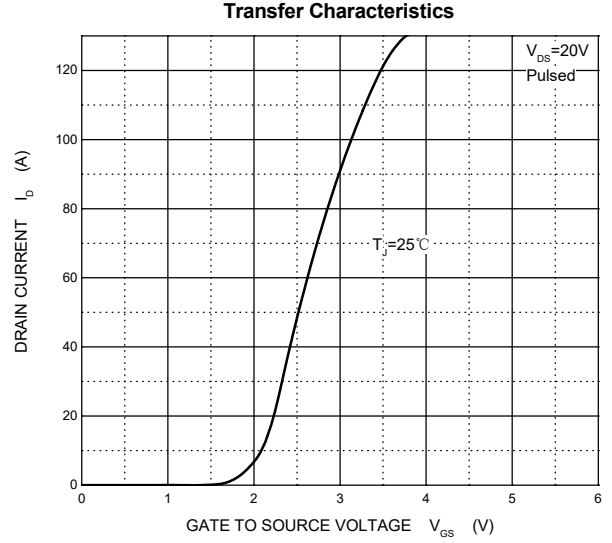
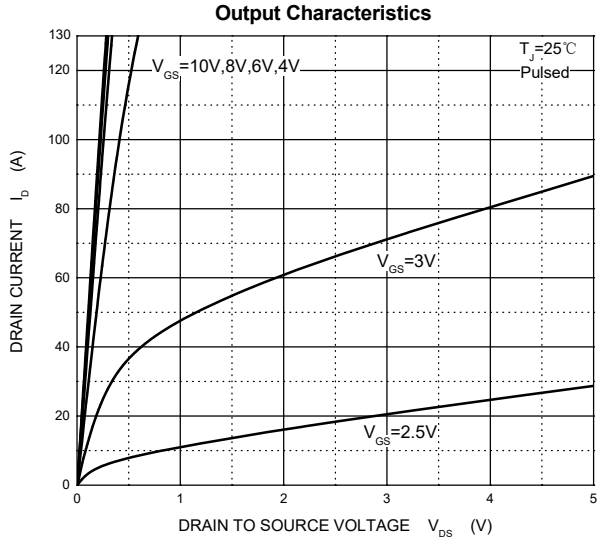

Typical Characteristics

Capacitances

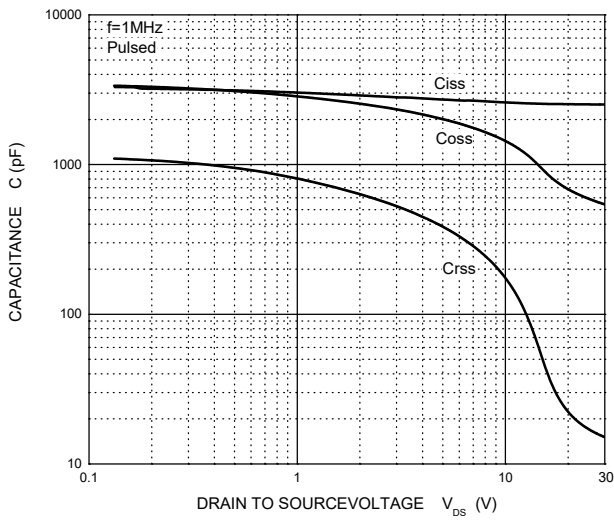

Gate Charge

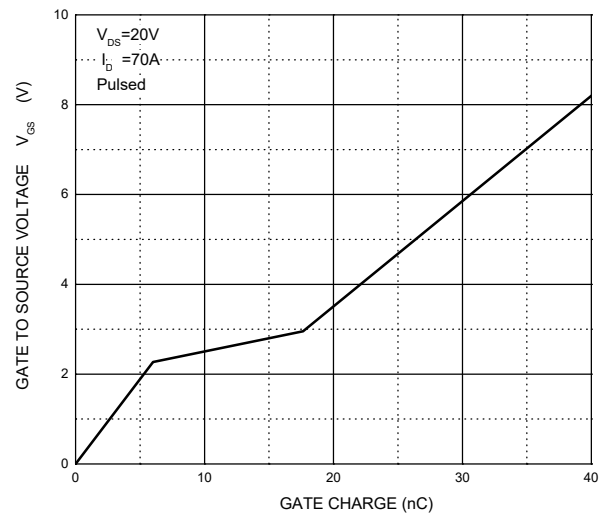

Maximum Safe Operating Area

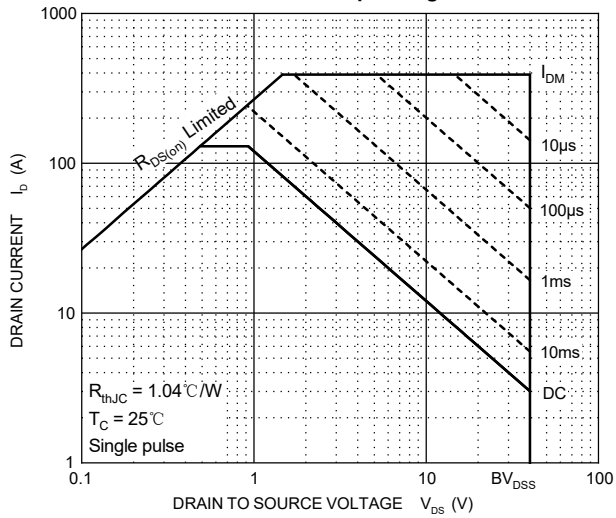

Transient Thermal Impedance, Junction-Case

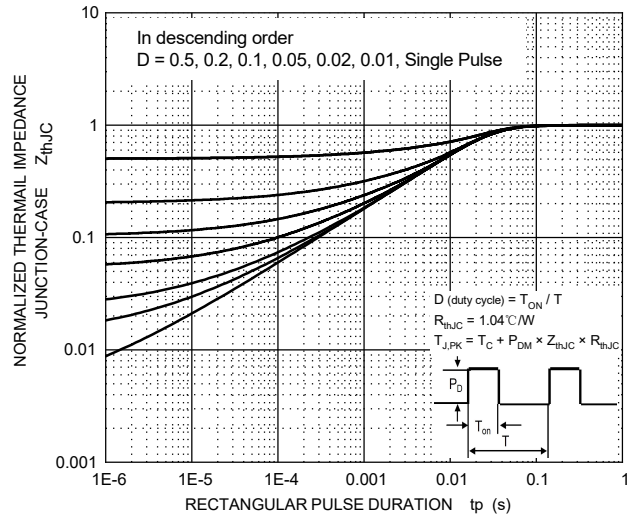

PDFNWB5×6-8L PACKAGE OUTLINE DIMENSIONS

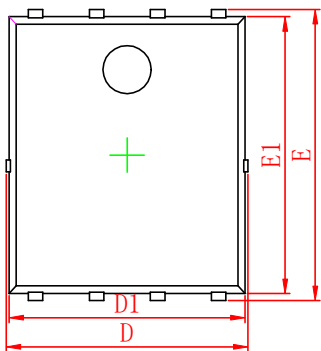

Top View
[顶视图]

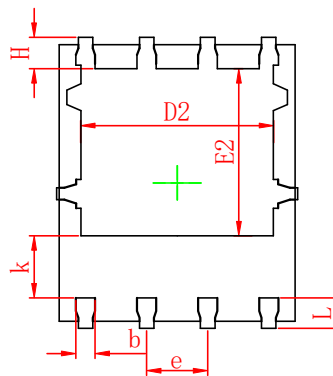

Bottom View
[背视图]

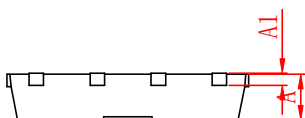

Side View
[侧视图]

Symbol	Dimensions In Millimeters		Dimensions In Inches	
	Min.	Max.	Min.	Max.
A	0.90	1.10	0.035	0.043
A1	0.25 REF.		0.010 REF.	
D	4.90	5.10	0.193	0.201
D1	4.80	5.00	0.189	0.197
D2	3.90	4.10	0.154	0.161
E	5.90	6.10	0.232	0.240
E1	5.65	5.85	0.222	0.230
E2	3.35	3.65	0.132	0.144
k	1.20	1.50	0.047	0.059
b	0.20	0.45	0.008	0.018
e	1.27 BSC		0.050 BSC	
L	0.55	0.75	0.022	0.030
H	0.45	0.75	0.018	0.030

Notes:

- 1 Dimensions exclusive of mold gate burrs.
- 2 Dimensions exclusive of mold flash and cutting burrs.

PDFNWB5×6-8L Suggested Pad Layout

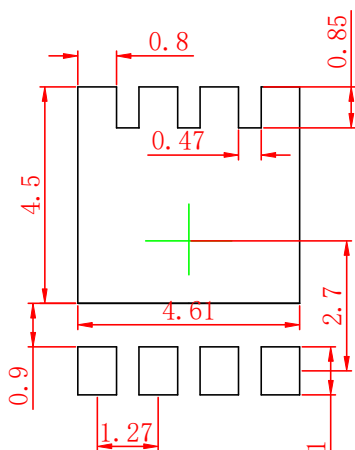

Notes:

- 1 Controlling dimension: in millimeters.
- 2 General tolerance: $\pm 0.05\text{mm}$.
- 3 The pad layout is for reference purpose only.

NOTICE

JSCJ reserves the right to make modifications, enhancements, improvements, corrections or other changes without further notice to any product herein. JSCJ does not assume any liability arising out of the application or use of any product described herein.

PDFNWB5×6-8L Tape and Reel

PDFNWB5×6-8L Embossed Carrier Tape



Packaging Description:
PDFNWB5×6-8L parts are shipped in tape. The carrier tape is made from a dissipative (carbon filled) polycarbonate resin. The cover tape is a multilayer film (Heat Activated Adhesive in nature) primarily composed of polyester film, adhesive layer, sealant, and anti-static sprayed agent. These reeled parts in standard option are shipped with 5,000 units per 13" or 33.0 cm diameter reel. The reels are clear in color and is made of polystyrene plastic (anti-static coated).

Dimensions are in millimeter										
Pkg type	A	B	C	d	E	F	P0	P	P1	W
PDFNWB5×6-8L	6.30	5.30	1.10	Ø1.50	1.75	5.50	4.00	8.00	2.00	12.00

PDFNWB5×6-8L Tape Leader and Trailer

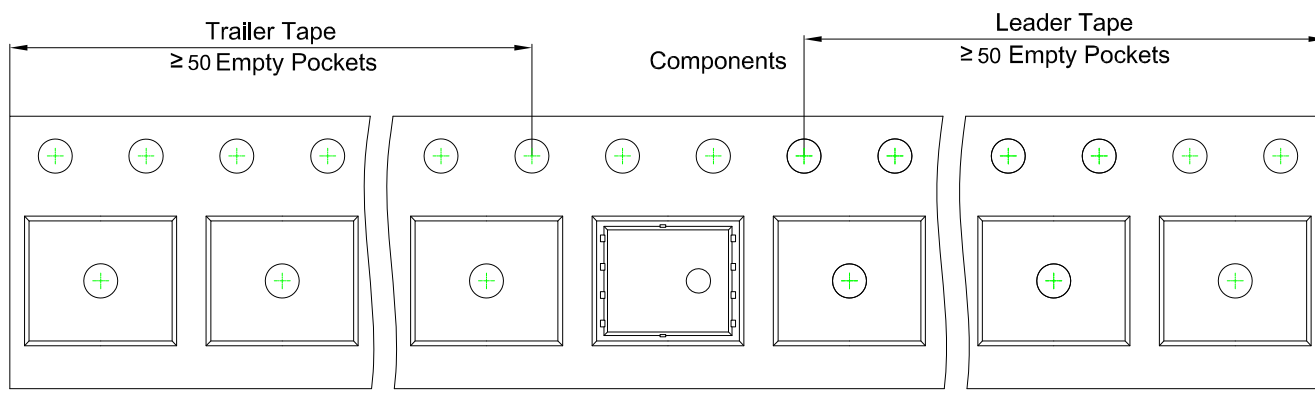

PDFNWB5×6-8L Reel

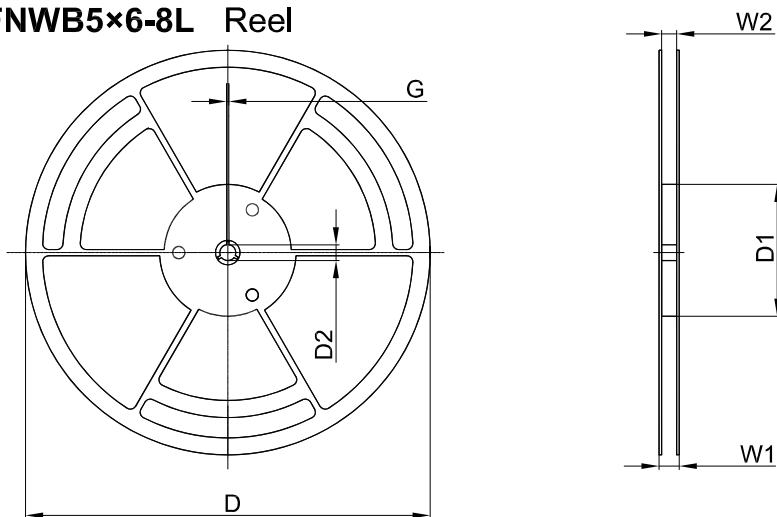

Dimensions are in millimeter						
Reel Option	D	D1	D2	G	W1	W2
13" Dia	φ330.00	100.00	13.00	1.90	17.60	12.40

Reel	Reel Size	Box	Box Size (mm)	Carton	Carton Size (mm)
5,000 pcs	13 inch	10,000 pcs	360×360×65	50,000 pcs	378×358×382