

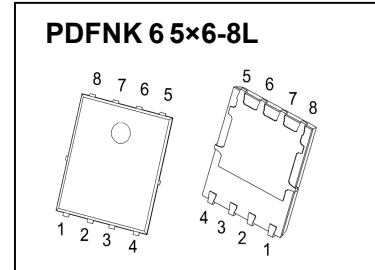

**PDFNK 6 5×6-8L Plastic-Encapsulate MOSFETS**

**CJAC150N03A N-Channel Power MOSFET**

$V_{(BR)DSS}$	$R_{DS(on)TYP}$	$I_D$
30V	1.4mΩ@10V	150A
	2.0mΩ@4.5V	



**DESCRIPTION**

The CJAC150N03A uses trench technology and design to provide excellent  $R_{DS(ON)}$  with low gate charge. It can be used in a wide variety of applications

**FEATURES**

- High Power and current handing capability
- Load switch
- High density cell design for ultra low  $R_{DS(ON)}$
- Lead free product is acquired
- Good stability and uniformity with high  $E_{AS}$
- Excellent package for good heat dissipation

**APPLICATIONS**

- SMPS and general purpose applications
- Hard switched and high frequency circuits
- Uninterruptible Power Supply
- Power management

**MARKING**

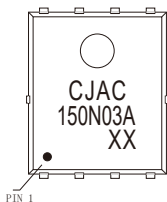

CJAC150N03A = Part No.  
 Solid dot=Pin1 indicator.  
 XX=Code.

**EQUIVALENT CIRCUIT**

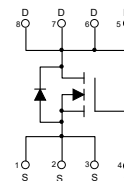

**MAXIMUM RATINGS (  $T_a=25^{\circ}C$  unless otherwise noted )**

Parameter	Symbol	Limit	Unit
Drain-Source Voltage	$V_{DS}$	30	V
Gate-Source Voltage	$V_{GS}$	±20	V
Continuous Drain Current	$I_D$ <sup>①</sup>	150	A
Pulsed Drain Current	$I_{DM}$ <sup>②</sup>	600	A
Single Pulsed Avalanche Energy	$E_{AS}$ <sup>③</sup>	325	mJ
Power Dissipation	$P_D$ <sup>①</sup>	130	W
Thermal Resistance from Junction to Ambient	$R_{\theta JA}$ <sup>⑥</sup>	62.5	°C/W
Thermal Resistance from Junction to Case	$R_{\theta JC}$ <sup>①</sup>	0.96	°C/W
Junction and Storage Temperature Range	$T_J, T_{stg}$	-55 ~+150	°C

# MOSFET ELECTRICAL CHARACTERISTICS

$T_a=25^\circ\text{C}$  unless otherwise specified

Parameter	Symbol	Test Condition	Min	Typ	Max	Unit
<b>Off characteristics</b>						
Drain-source breakdown voltage	$V_{(BR)DSS}$	$V_{GS} = 0V, I_D = 250\mu A$	30			V
Zero gate voltage drain current	$I_{DSS}$	$V_{DS} = 24V, V_{GS} = 0V$	$T_J = 25^\circ\text{C}$		1.0	$\mu A$
			$T_J = 125^\circ\text{C}$		100	
Gate-body leakage current	$I_{GSS}$	$V_{DS} = 0V, V_{GS} = \pm 20V$			$\pm 100$	nA
<b>On characteristics</b> <sup>④</sup>						
Gate-threshold voltage	$V_{GS(th)}$	$V_{DS} = V_{GS}, I_D = 250\mu A$	1.0	1.6	2.5	V
Static drain-source on-state resistance	$R_{DS(on)}$	$V_{GS} = 10V, I_D = 30A$		1.4	2.0	$m\Omega$
		$V_{GS} = 4.5V, I_D = 10A$		2.0	2.7	$m\Omega$
<b>Dynamic characteristics</b> <sup>④ ⑤</sup>						
Input capacitance	$C_{iss}$	$V_{DS} = 15V, V_{GS} = 0V, f = 100\text{KHz}$		10300	20000	$\mu F$
Output capacitance	$C_{oss}$			1020	1800	
Reverse transfer capacitance	$C_{rss}$			806	1500	
Gate resistance	$R_g$	$f = 1\text{MHz}$		1.2		$\Omega$
<b>Switching characteristics</b> <sup>④ ⑤</sup>						
Total gate charge	$Q_g$	$V_{GS} = 10V, V_{DS} = 15V, I_D = 24A$		82		nC
Gate-source charge	$Q_{gs}$			22		
Gate-drain charge	$Q_{gd}$			31		
Turn-on delay time	$t_{d(on)}$	$V_{DS} = 15V, V_{GS} = 10V, R_G = 1\Omega, R_L = 0.75\Omega$		40		ns
Turn-on rise time	$t_r$			58		
Turn-off delay time	$t_{d(off)}$			87		
Turn-off fall time	$t_f$			35		
<b>Drain-Source Diode Characteristics</b>						
Drain-source diode forward voltage	$V_{SD}$ <sup>④</sup>	$V_{GS} = 0V, I_S = 10A$			1.2	V
Continuous drain-source diode forward current	$I_S$ <sup>①</sup>				150	A
Pulsed drain-source diode forward current	$I_{SM}$ <sup>②</sup>				600	A

Notes:

- $T_C = 25^\circ\text{C}$  Limited only by maximum temperature allowed.
- $P_W \leq 10\mu s$ , Duty cycle  $\leq 1\%$ .
- EAS condition:  $V_{DD} = 25V, V_{GS} = 10V, L = 0.5mH, R_g = 25\Omega$  Starting  $T_J = 25^\circ\text{C}$ .
- Pulse Test : Pulse Width  $\leq 300\mu s$ , duty cycle  $\leq 2\%$ .
- Guaranteed by design, not subject to production.
- The value of  $R_{\theta JA}$  is measured with the device mounted on 1 in 2 FR-4 board with 2oz. Copper, in a still air environment with  $T_a = 25^\circ\text{C}$ .

# Typical Characteristics

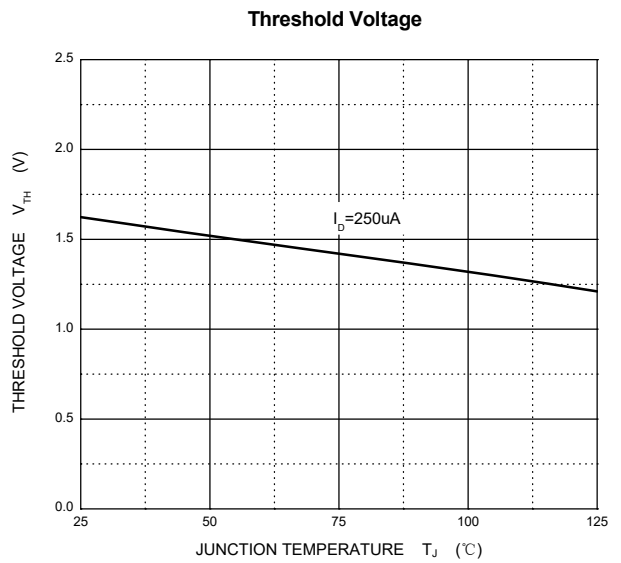
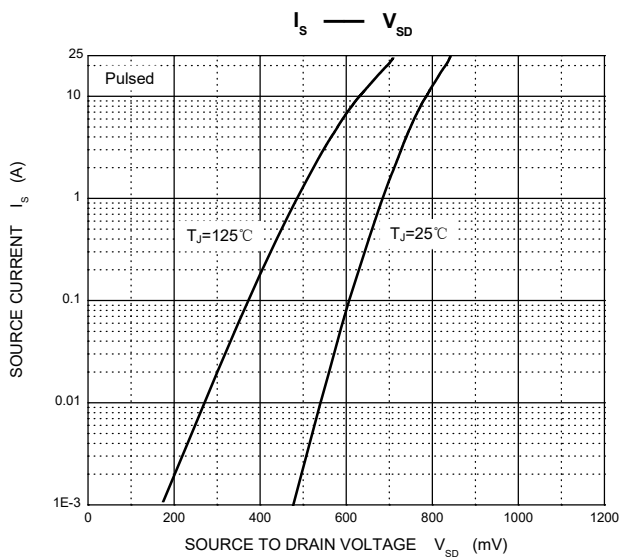
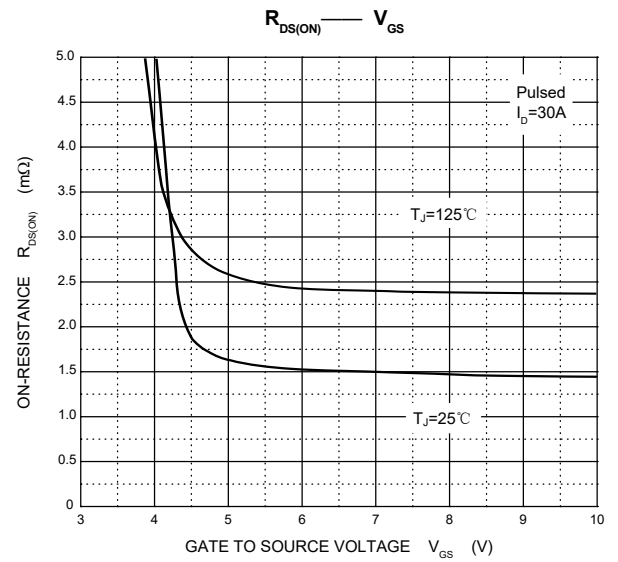
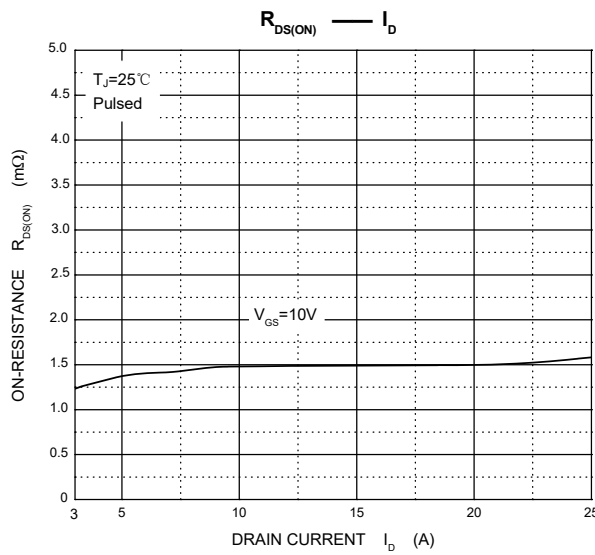
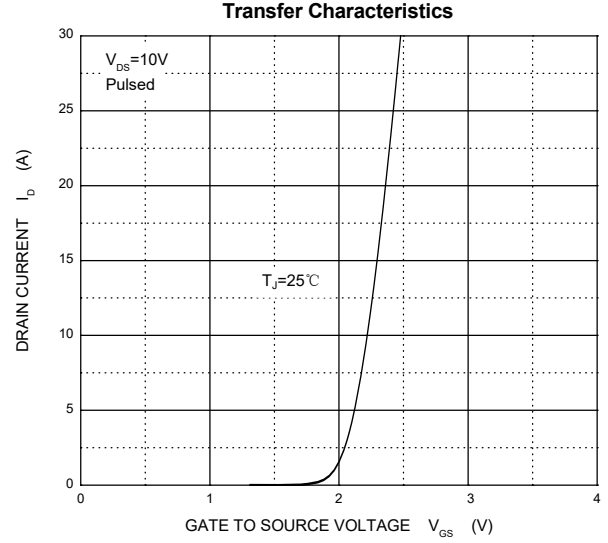
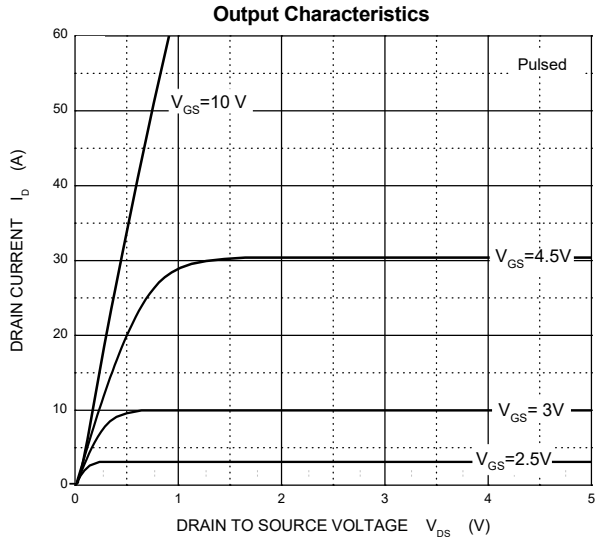

# Typical Characteristics

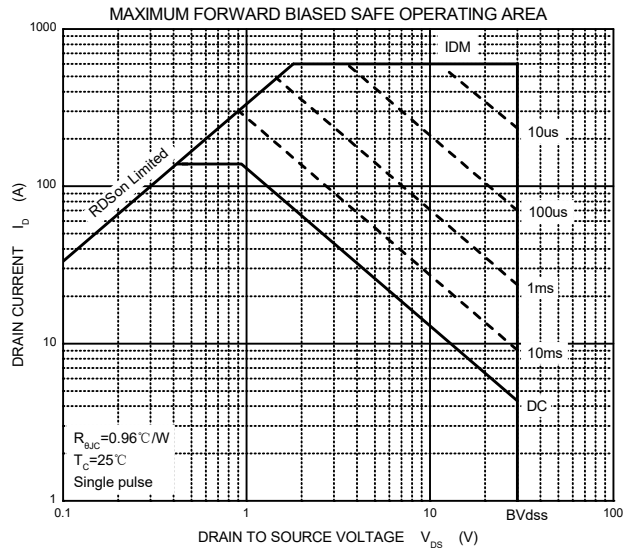
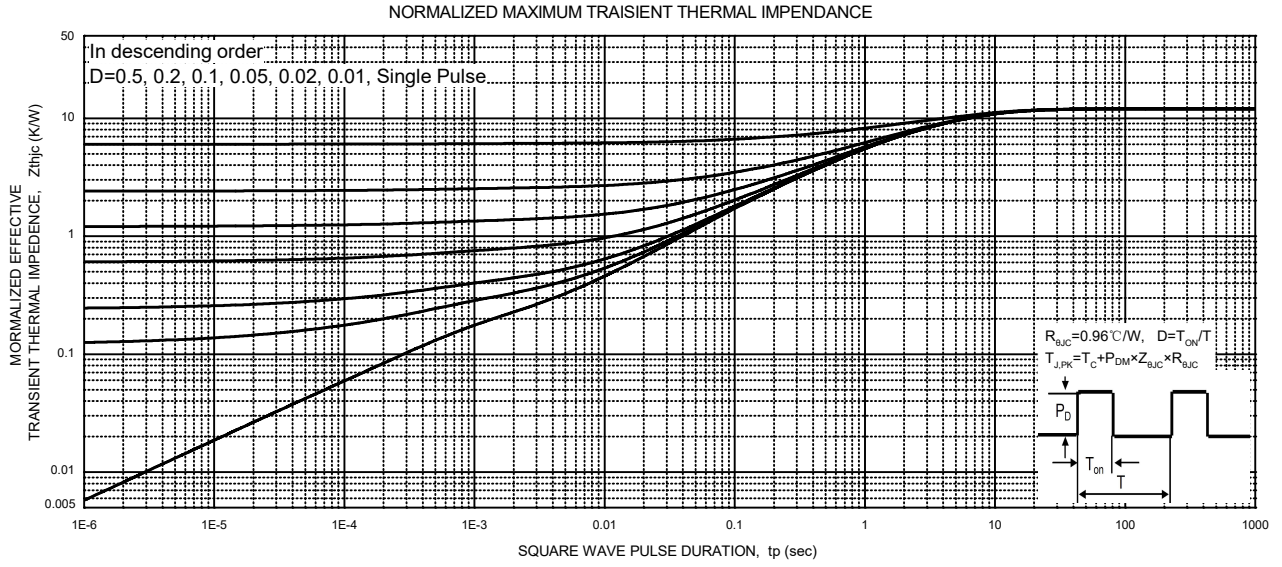

# PDFNWB5×6-8L PACKAGE OUTLINE DIMENSIONS

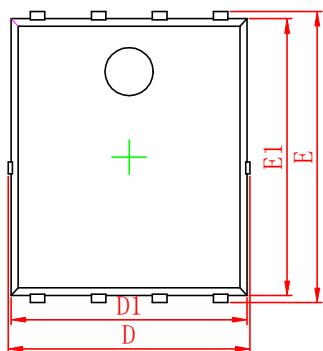

Top View  
[顶视图]

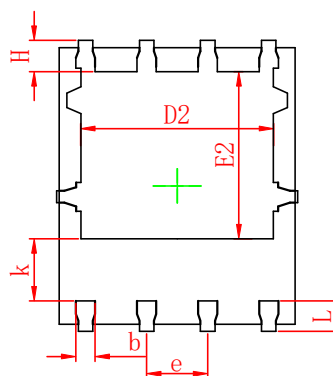

Bottom View  
[背视图]

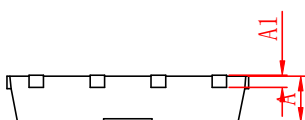

Side View  
[侧视图]

Symbol	Dimensions In Millimeters		Dimensions In Inches	
	Min.	Max.	Min.	Max.
A	0.90	1.10	0.035	0.043
A1	0.25 REF.		0.010 REF.	
D	4.90	5.10	0.193	0.201
D1	4.80	5.00	0.189	0.197
D2	3.90	4.10	0.154	0.161
E	5.90	6.10	0.232	0.240
E1	5.65	5.85	0.222	0.230
E2	3.35	3.65	0.132	0.144
k	1.20	1.50	0.047	0.059
b	0.20	0.45	0.008	0.018
e	1.27 BSC		0.050 BSC	
L	0.55	0.75	0.022	0.030
H	0.45	0.75	0.018	0.030

## Notes:

- 1 Dimensions exclusive of mold gate burrs.
- 2 Dimensions exclusive of mold flash and cutting burrs.

## PDFNWB5×6-8L Suggested Pad Layout

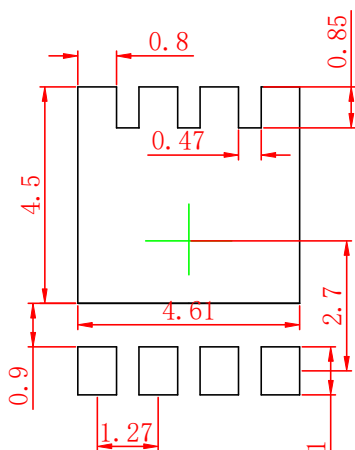

## Notes:

- 1 Controlling dimension: in millimeters.
- 2 General tolerance:  $\pm 0.05\text{mm}$ .
- 3 The pad layout is for reference purpose only.

## NOTICE

JSCJ reserves the right to make modifications, enhancements, improvements, corrections or other changes without further notice to any product herein. JSCJ does not assume any liability arising out of the application or use of any product described herein.

# PDFNWB5×6-8L Tape and Reel

## PDFNWB5×6-8L Embossed Carrier Tape



**Packaging Description:**  
**PDFNWB5×6-8L** parts are shipped in tape. The carrier tape is made from a dissipative (carbon filled) polycarbonate resin. The cover tape is a multilayer film (Heat Activated Adhesive in nature) primarily composed of polyester film, adhesive layer, sealant, and anti-static sprayed agent. These reeled parts in standard option are shipped with 5,000 units per 13" or 33.0 cm diameter reel. The reels are clear in color and is made of polystyrene plastic (anti-static coated).

Dimensions are in millimeter										
Pkg type	A	B	C	d	E	F	P0	P	P1	W
PDFNWB5×6-8L	6.30	5.30	1.10	Ø1.50	1.75	5.50	4.00	8.00	2.00	12.00

## PDFNWB5×6-8L Tape Leader and Trailer

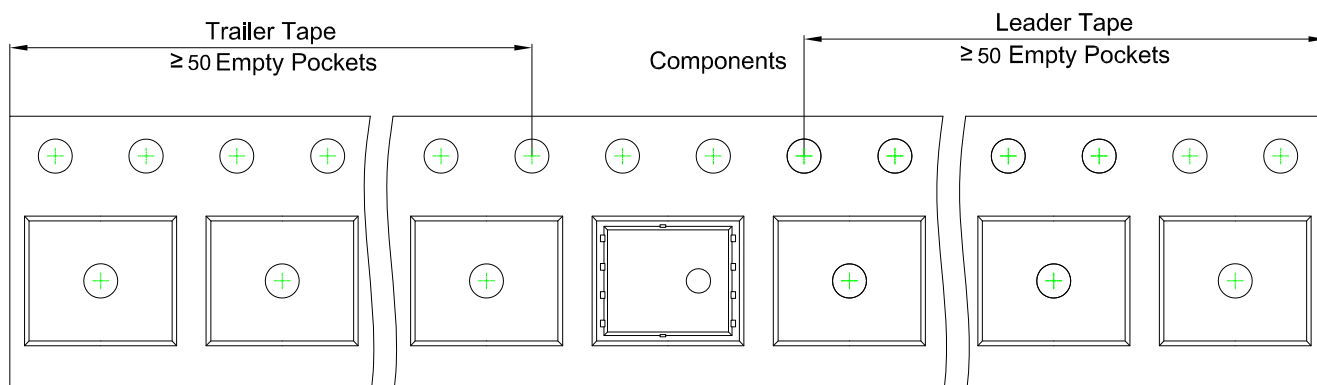

## PDFNWB5×6-8L Reel

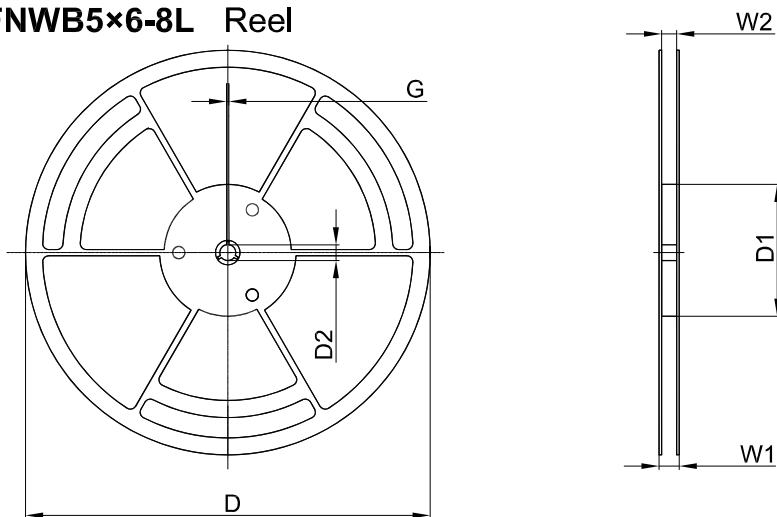

Dimensions are in millimeter						
Reel Option	D	D1	D2	G	W1	W2
13" Dia	φ330.00	100.00	13.00	1.90	17.60	12.40

Reel	Reel Size	Box	Box Size (mm)	Carton	Carton Size (mm)
5,000 pcs	13 inch	10,000 pcs	360×360×65	50,000 pcs	378×358×382