

PDFNWB5x6-8L Plastic-Encapsulate MOSFET

CJAC5R0SN03A N-Channel Power MOSFET

Key Performance Parameters

V_{BR(DSS)}	R_{DS(on)}TYP	I_D
30V	3.7mΩ@10V	80A
	5.7mΩ@4.5V	

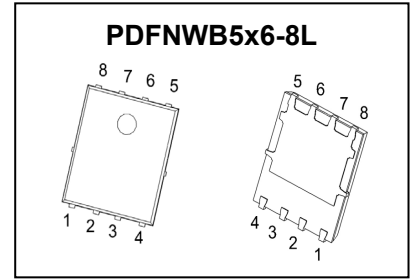

DESCRIPTION

The N-Channel enhancement mode power field effect transistors is using SGT technology. This advanced technology has been especially tailored to minimize on-state resistance, provide superior switching performance. These devices are well suited for high efficiency fast switching applications.

FEATURES

- 100% Avalanche Tested
- Low drain-source on-resistance:
R_{DS(ON)} = 3.7 mΩ (typ.) (V_{GS} = 10V)
- Excellent package for good heat dissipation

APPLICATIONS

- High-Efficiency DC-DC Converters
- Switching Voltage Regulators
- Motor Drivers

MARKING

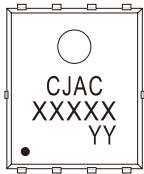

XXXXX = 5R0SN03A
Solid dot = Pin1 indicator.
YY = Code.

EQUIVALENT CIRCUIT

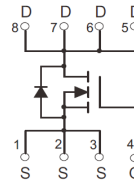

ABSOLUTE MAXIMUM RATINGS (T_J=25°C unless otherwise specified)

Parameter	Symbol	Value	Unit
Drain-Source Voltage	V _{DS}	30	V
Gate-Source Voltage	V _{GS}	±20	V
Continuous Drain Current	I _D	T _C = 25°C	80
		T _C = 100°C	50.6
Pulsed Drain Current	I _{DM} ^{①②}	320	A
Continuous Drain Current	I _D	T _A = 25°C	15.9
		T _A = 75°C	12.3
Avalanche Current	I _{AS} ^③	12	A
Single Pulsed Avalanche Energy	E _{AS} ^③	36	mJ
Power Dissipation	P _D ^①	54	W
Operating Junction and Storage Temperature Range	T _J , T _{stg}	-55~+150	°C

Thermal Characteristics

Parameter	Symbol	Value		Unit
		Typ	Max	
Thermal Resistance from Junction to Case	R _{θJC}	1.5	2.3	°C/W
Thermal Resistance from Junction to Ambient	R _{θJA} ^⑥	50	62.5	°C/W

Typical Characteristics

ELECTRICAL CHARACTERISTICS (T_J=25°C unless otherwise specified)

Static Characteristics

Parameter	Symbol	Test Condition	Value			Unit	
			Min	Typ	Max		
Drain-source breakdown voltage	V _{(BR)DSS}	V _{GS} = 0V, I _D = 250μA	30	-	-	V	
Zero gate voltage drain current	I _{DSS}	V _{DS} = 30V, V _{GS} = 0V	T _J = 25°C	-	-	1.0	μA
			T _J = 125°C	-	-	100	
Gate-body leakage current	I _{GSS}	V _{GS} = ±20V, V _{DS} = 0V	-	-	±100	nA	
Gate-threshold voltage	V _{GS(th)}	V _{DS} = V _{GS} , I _D = 250μA	1.4	1.8	2.2	V	
Static drain-source on-state resistance	R _{DS(on)} ^④	V _{GS} = 10V, I _D = 20A	T _J = 25°C	-	3.7	5.0	mΩ
			T _J = 125°C	-	5.3	7.2	
		V _{GS} = 4.5V, I _D = 20A	-	5.7	7.8		
Forward transconductance	g _{FS}	V _{DS} = 5V, I _D = 20A	-	80	-	S	

Dynamic Characteristics^⑤

Input capacitance	C _{iss}	V _{GS} = 0V, V _{DS} = 15V, f = 1MHz	-	789	-	pF
Output capacitance	C _{oss}		-	595	-	
Reverse transfer capacitance	C _{riss}		-	17	-	
Gate resistance	R _g	f = 1MHz	-	2.0	-	Ω
Total gate charge	Q _g	V _{GS} = 4.5V, V _{DS} = 15V, I _D = 20A	-	5.0	-	nC
Total gate charge	Q _g	V _{GS} = 10V, V _{DS} = 15V, I _D = 20A	-	11	-	
Gate charge at threshold	Q _{G(th)}		-	1.8	-	
Gate-source charge	Q _{gs}		-	2.3	-	
Gate-drain charge	Q _{gd}		-	1.2	-	
Turn-on delay time	t _{d(on)}	V _{DD} = 15V, V _{GS} = 10V, I _D = 20A, R _g = 3Ω	-	3.4	-	ns
Turn-on rise time	t _r		-	2.1	-	
Turn-off delay time	t _{d(off)}		-	10.7	-	
Turn-off fall time	t _f		-	1.8	-	

Reverse Diode Characteristics

Drain-source diode forward voltage	V _{SD} ^④	V _{GS} = 0V, I _S = 20A	-	-	1.2	V
Continuous drain-source diode forward current	I _S ^①		-	-	80	A
Pulsed drain-source diode forward current	I _{SM} ^{①②}		-	-	320	A
Reverse recovery time	t _{rr}	V _{DD} = 15V, I _S = 20A,	-	10.9	-	ns
Reverse recovery charge	Q _{rr}	di/dt = 500A/μs	-	16.2	-	nC

Notes:

- ①. T_C = 25°C Limited only by maximum temperature allowed.
- ②. P_W ≤ 10μs, Duty cycle ≤ 1%.
- ③. EAS condition: V_{DD} = 15V, V_{GS} = 10V, L = 0.5mH, R_g = 25Ω Starting T_J = 25°C.
- ④. Pulse Test : Pulse Width ≤ 380μs, duty cycle ≤ 2%.
- ⑤. Guaranteed by design, not subject to production.
- ⑥. Device mounted on 1 in² FR-4 board with 2oz. double-sided Copper, in a still air environment with T_A = 25°C.

Typical Characteristics

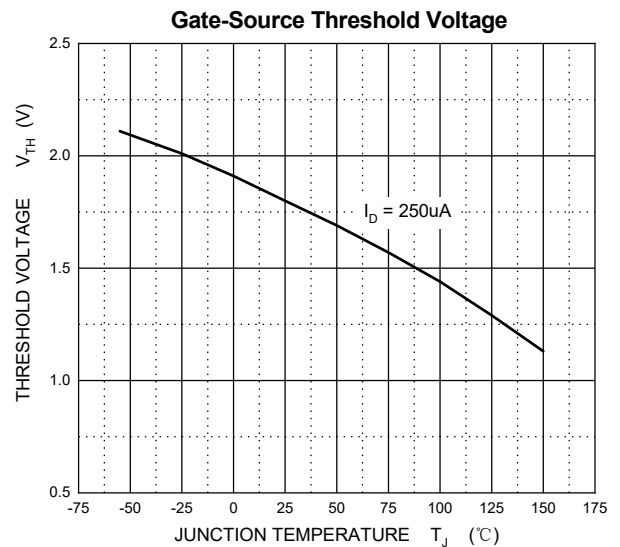
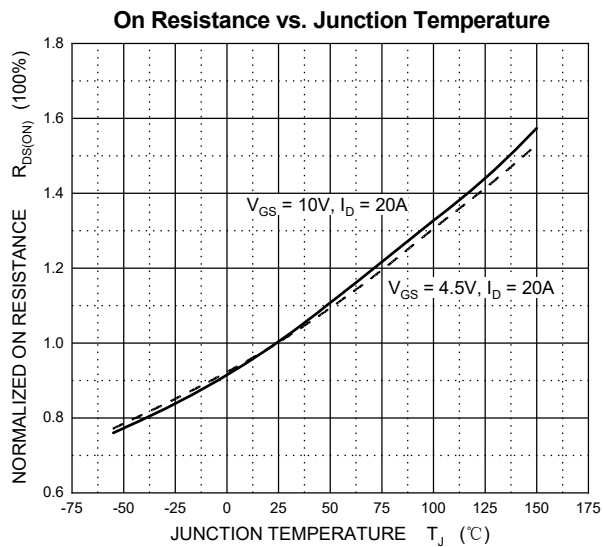
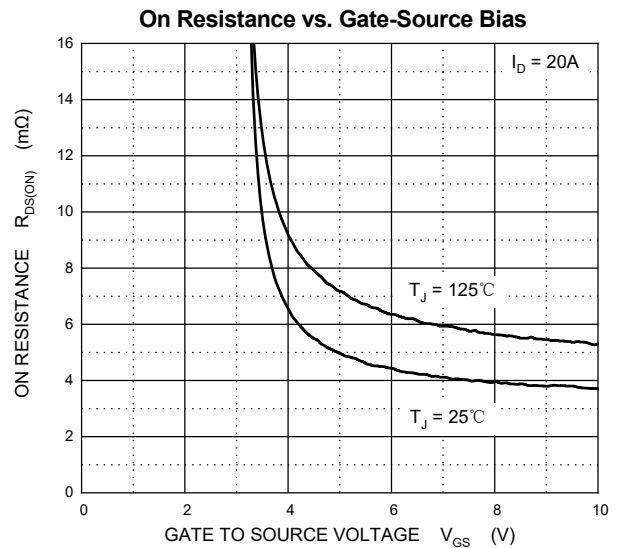
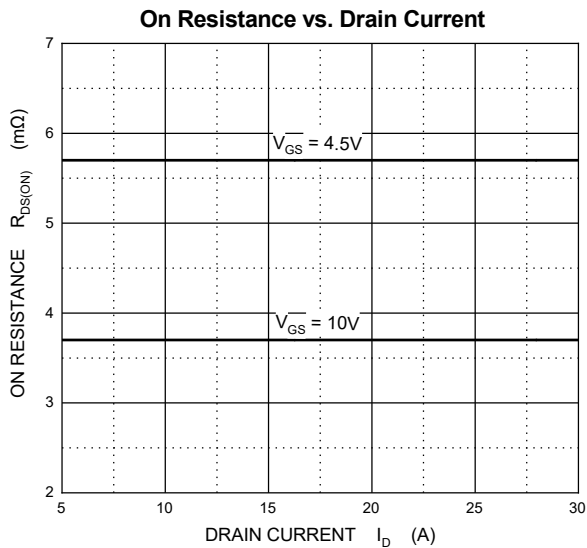
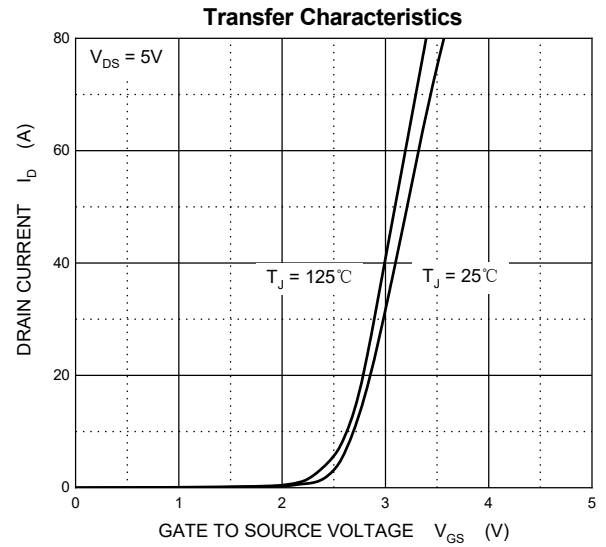
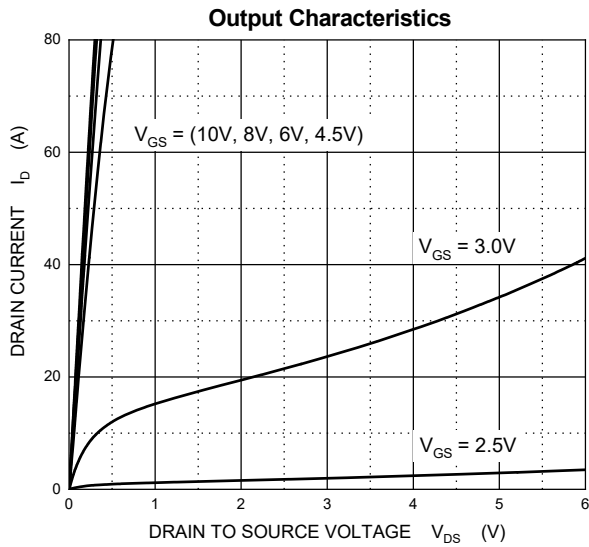

Typical Characteristics

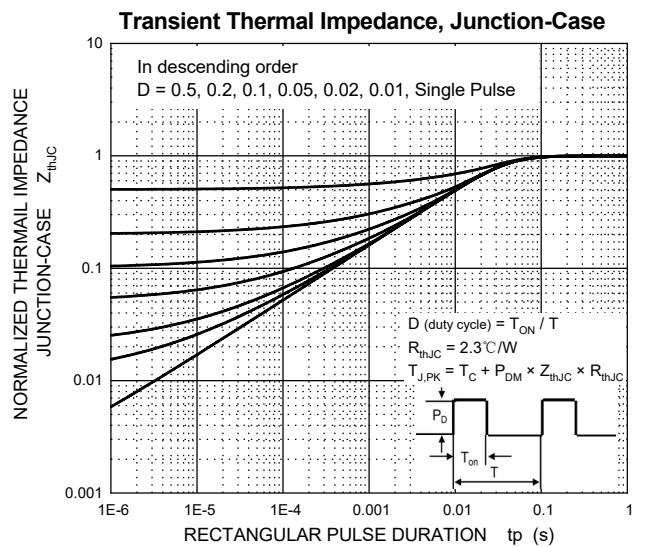
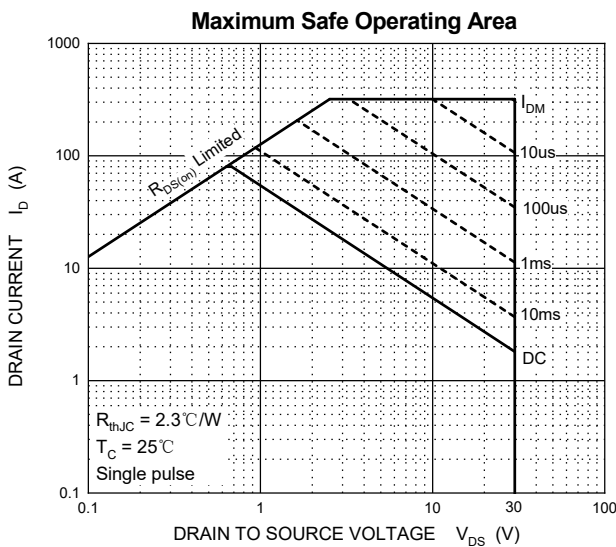
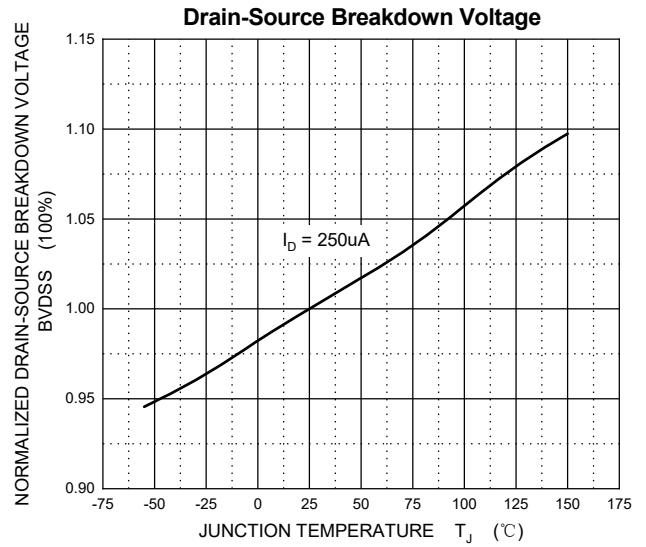
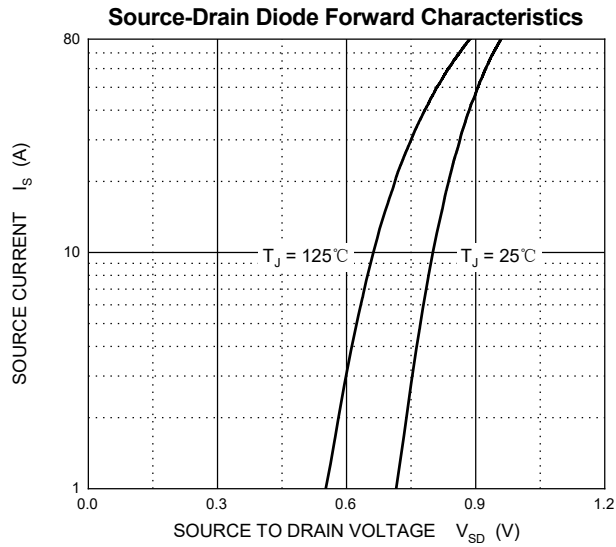
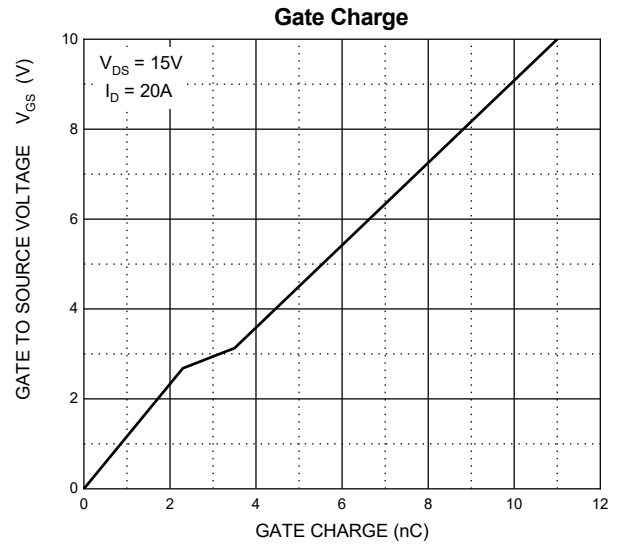
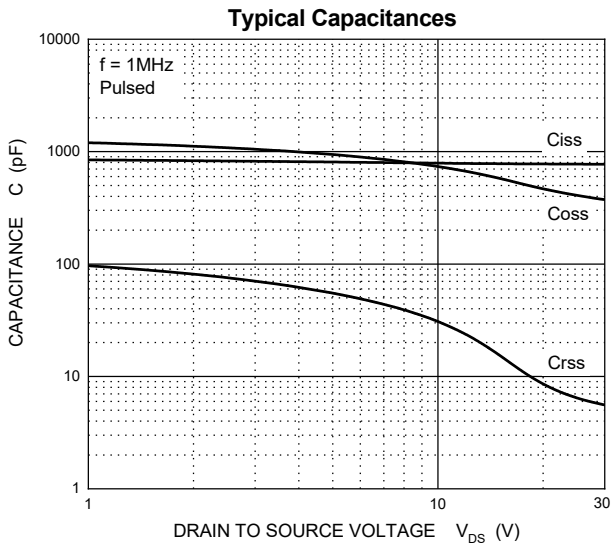

Typical Characteristics

ID vs. TC

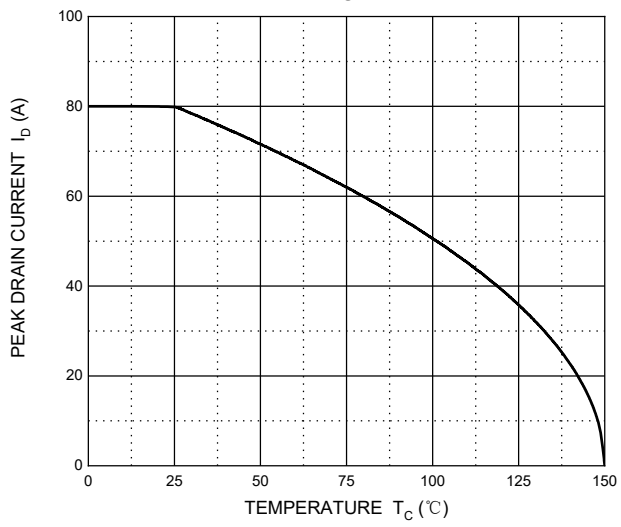

Normalized Threshold Voltage vs. Junction Temperature

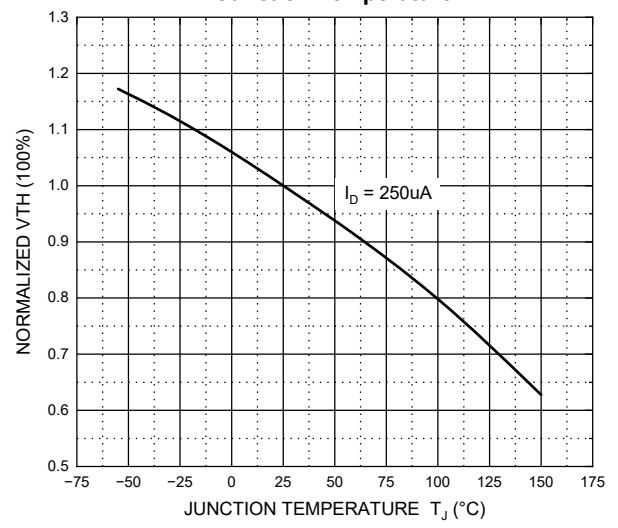

Gate Charge

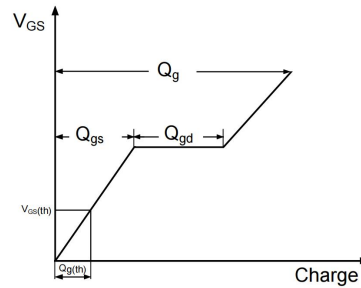
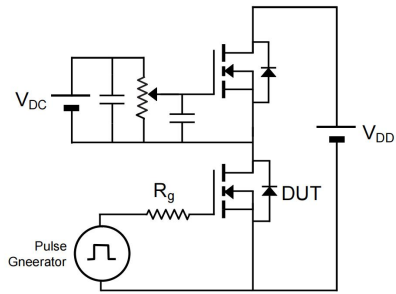

Resistive Load Switching Time

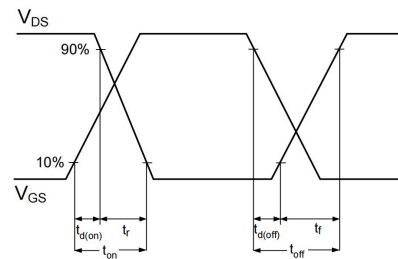
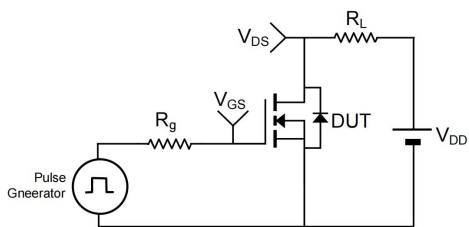

Un-clamped Inductive Load Switching

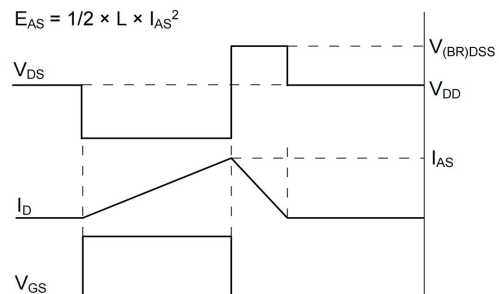
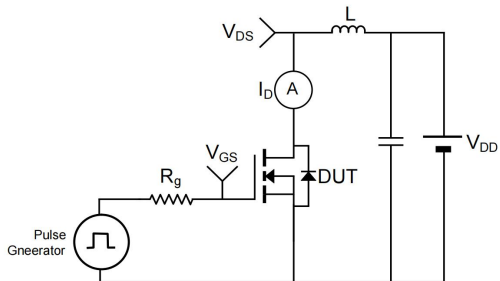

Drain-Source Body Diode Reverse Recovery

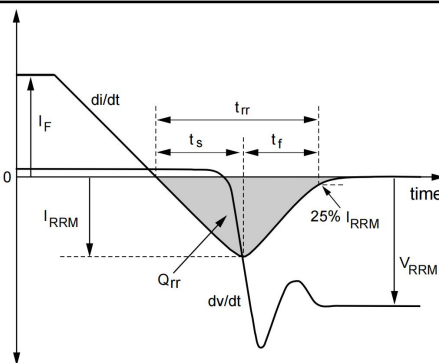
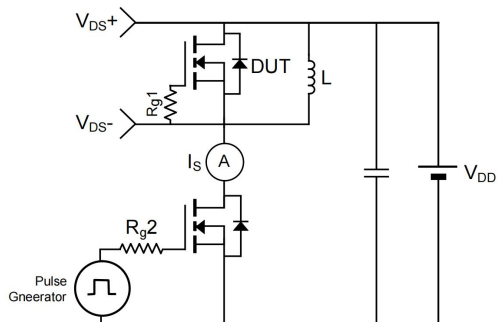

PDFNWB5×6-8L PACKAGE OUTLINE DIMENSIONS

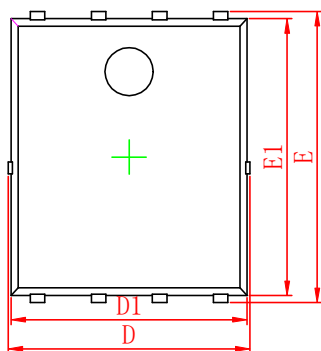

Top View
[顶视图]

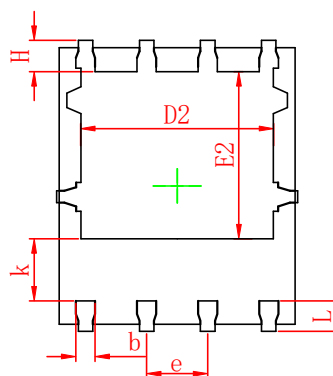

Bottom View
[背视图]

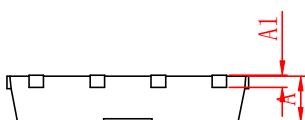

Side View
[侧视图]

Symbol	Dimensions In Millimeters		Dimensions In Inches	
	Min.	Max.	Min.	Max.
A	0.90	1.10	0.035	0.043
A1	0.25 REF.		0.010 REF.	
D	4.90	5.10	0.193	0.201
D1	4.80	5.00	0.189	0.197
D2	3.90	4.10	0.154	0.161
E	5.90	6.10	0.232	0.240
E1	5.65	5.85	0.222	0.230
E2	3.35	3.65	0.132	0.144
k	1.20	1.50	0.047	0.059
b	0.20	0.45	0.008	0.018
e	1.27 BSC		0.050 BSC	
L	0.55	0.75	0.022	0.030
H	0.45	0.75	0.018	0.030

Notes:

- 1 Dimensions exclusive of mold gate burrs.
- 2 Dimensions exclusive of mold flash and cutting burrs.

PDFNWB5×6-8L Suggested Pad Layout

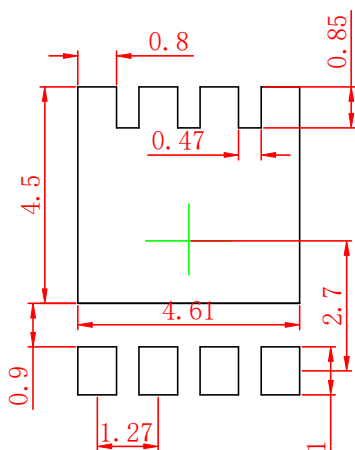

Notes:

- 1 Controlling dimension: in millimeters.
- 2 General tolerance: $\pm 0.05\text{mm}$.
- 3 The pad layout is for reference purpose only.

NOTICE

JSCJ reserves the right to make modifications, enhancements, improvements, corrections or other changes without further notice to any product herein. JSCJ does not assume any liability arising out of the application or use of any product described herein.

PDFNWB5×6-8L Tape and Reel

PDFNWB5×6-8L Embossed Carrier Tape

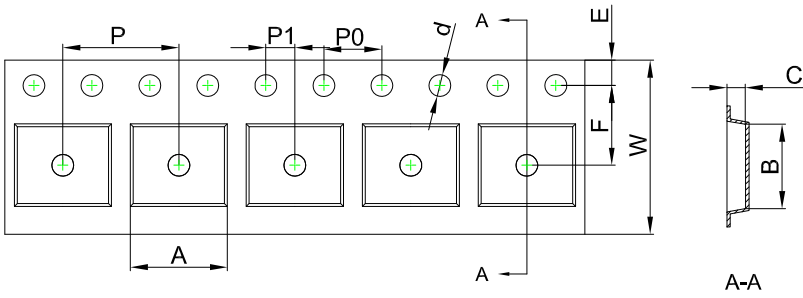

Packaging Description:
PDFNWB5×6-8L parts are shipped in tape. The carrier tape is made from a dissipative (carbon filled) polycarbonate resin. The cover tape is a multilayer film (Heat Activated Adhesive in nature) primarily composed of polyester film, adhesive layer, sealant, and anti-static sprayed agent. These reeled parts in standard option are shipped with 5,000 units per 13" or 33.0 cm diameter reel. The reels are clear in color and is made of polystyrene plastic (anti-static coated).

Dimensions are in millimeter										
Pkg type	A	B	C	d	E	F	P0	P	P1	W
PDFNWB5×6-8L	6.30	5.30	1.10	Ø1.50	1.75	5.50	4.00	8.00	2.00	12.00

PDFNWB5×6-8L Tape Leader and Trailer

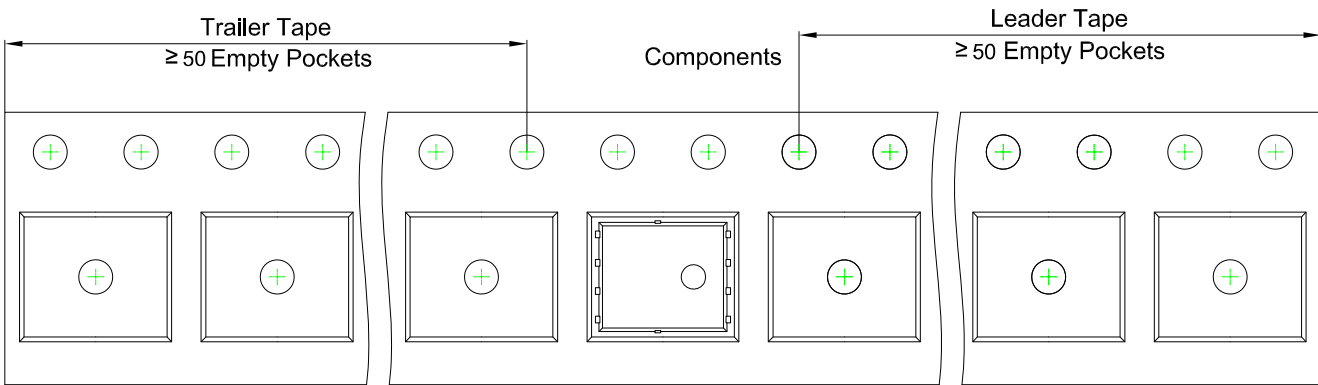

PDFNWB5×6-8L Reel

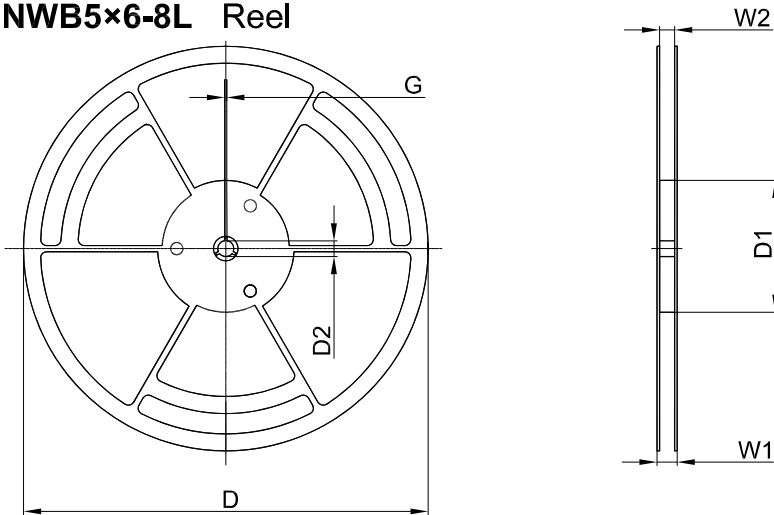

Dimensions are in millimeter						
Reel Option	D	D1	D2	G	W1	W2
13" Dia	φ330.00	100.00	13.00	1.90	17.60	12.40

Reel	Reel Size	Box	Box Size (mm)	Carton	Carton Size (mm)
5,000 pcs	13 inch	10,000 pcs	360×360×65	50,000 pcs	378×358×382