

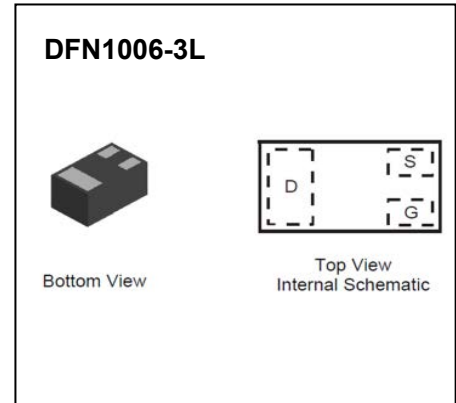

DFN1006-3L Plastic-Encapsulate MOSFETs

CJBA3139K P-Channel MOSFET

$V_{(BR)DSS}$	$R_{DS(on)MAX}$	I_D
-20V	520mΩ@-4.5V	-0.66A
	780mΩ@-2.5V	
	950mΩ(TYP)@-1.8V	



FEATURE

- Lead Free Product is Acquired
- Surface Mount Package
- P-Channel Switch with Low $R_{DS(on)}$
- Operated at Low Logic Level Gate Drive
- ESD Protected Gate

APPLICATION

- Load/ Power Switching
- Interfacing Switching
- Battery Management for Ultra Small Portable Electronics
- Logic Level Shift

MARKING:

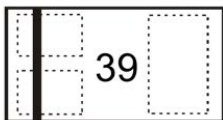

Top View
Bar Denotes Gate and Source Side

Equivalent Circuit

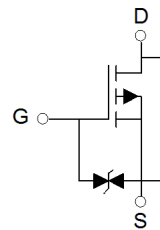

ABSOLUTE MAXIMUM RATINGS ($T_a=25^\circ\text{C}$ unless otherwise noted)

Parameter	Symbol	Value	Unit
Drain-Source Voltage	V_{DS}	-20	V
Typical Gate-Source Voltage	V_{GS}	± 12	V
Continuous Drain Current (note 1)	I_D	-0.66	A
Pulsed Drain Current ($t_p=10\mu\text{s}$)	I_{DM}	-2.64	A
Power Dissipation (note 1)	P_D	275	mW
Thermal Resistance from Junction to Ambient (note 1)	$R_{\theta JA}$	455	$^\circ\text{C}/\text{W}$
Operation Junction and Storage Temperature Range	T_J, T_{STG}	-55~ 150	$^\circ\text{C}$
Lead Temperature for Soldering Purposes(1/8" from case for 10 s)	T_L	260	$^\circ\text{C}$

MOSFET ELECTRICAL CHARACTERISTICS

$T_a=25^{\circ}\text{C}$ unless otherwise noted

Parameter	Symbol	Test Condition	Min	Typ	Max	Unit
STATIC PARAMETERS						
Drain-source breakdown voltage	$V_{(BR)DSS}$	$V_{GS} = 0V, I_D = -250\mu A$	-20			V
Zero gate voltage drain current	I_{DSS}	$V_{DS} = -20V, V_{GS} = 0V$			-1	μA
Gate-body leakage current	I_{GSS}	$V_{GS} = \pm 10V, V_{DS} = 0V$			± 20	μA
Gate threshold voltage (note 2)	$V_{GS(th)}$	$V_{DS} = V_{GS}, I_D = -250\mu A$	-0.35	-0.61	-1.1	V
Drain-source on-resistance(note 2)	$R_{DS(on)}$	$V_{GS} = -4.5V, I_D = -1A$		450	520	$m\Omega$
		$V_{GS} = -2.5V, I_D = -0.8A$		650	780	$m\Omega$
		$V_{GS} = -1.8V, I_D = -0.5A$		950		$m\Omega$
Forward tranconductance(note 2)	g_{FS}	$V_{DS} = -10V, I_D = -0.54A$		1.2		S
Diode forward voltage	V_{SD}	$I_S = -0.5A, V_{GS} = 0V$			-1.2	V
DYNAMIC PARAMETERS(note 4)						
Input Capacitance	C_{iss}	$V_{DS} = -16V, V_{GS} = 0V, f = 1MHz$		113		μF
Output Capacitance	C_{oss}			15		μF
Reverse Transfer Capacitance	C_{rss}			9		μF
SWITCHING PARAMETERS (note 4)						
Turn-on delay time (note 3)	$t_{d(on)}$	$V_{DD} = -4.5V, V_{GS} = -10V,$ $I_D = -200mA, R_{GEN} = 10\Omega$		9		ns
Turn-on rise time (note 3)	t_r			5.7		ns
Turn-off delay time (note 3)	$t_{d(off)}$			32.6		ns
Turn-off fall time (note 3)	t_f			20.3		ns

Notes:

1. Surface mounted on FR4 board using 1 square inch pad size, 1oz copper.
2. Pulse Test : Pulse Width=300 μs , Duty Cycle=2%.
3. Switching characteristics are independent of operating junction temperatures.
4. Guaranteed by design, not subject to producing.

Typical Characteristics

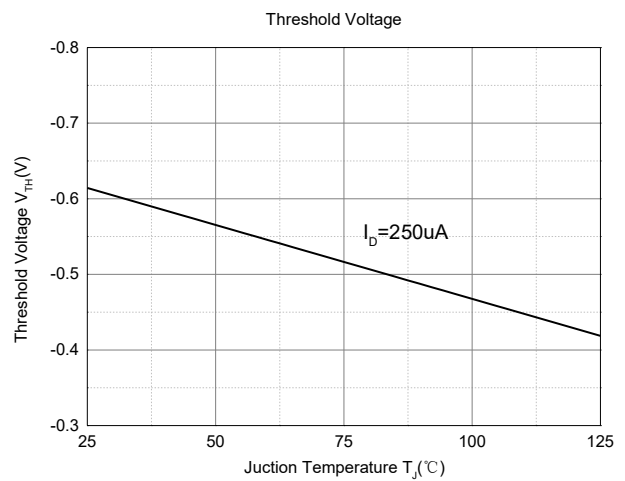
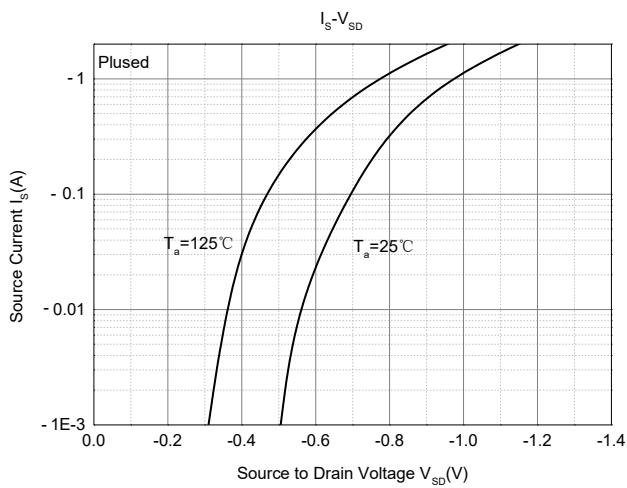
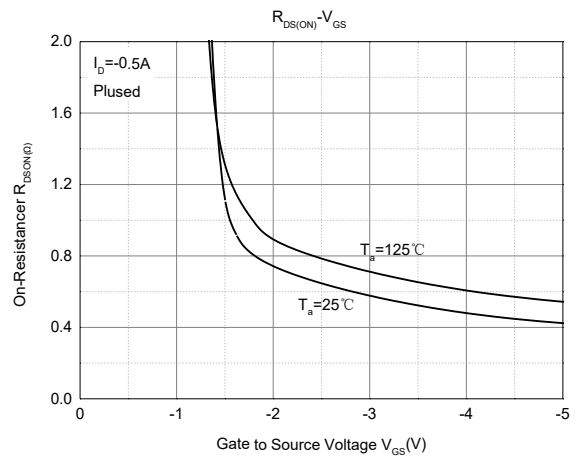
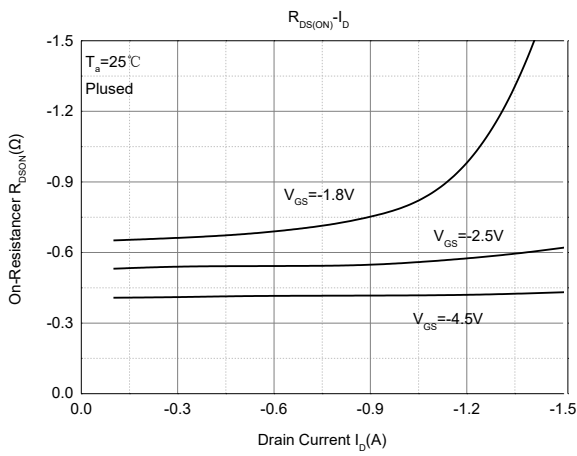
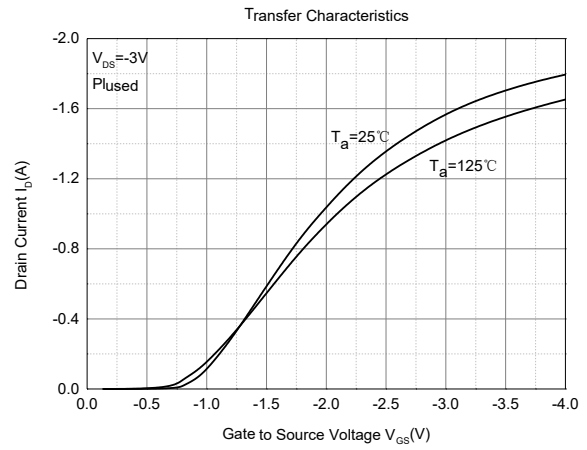
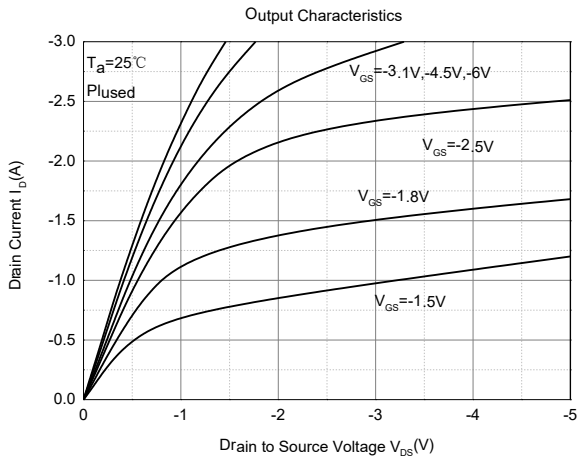

DFN1006-3L Package Outline Dimensions

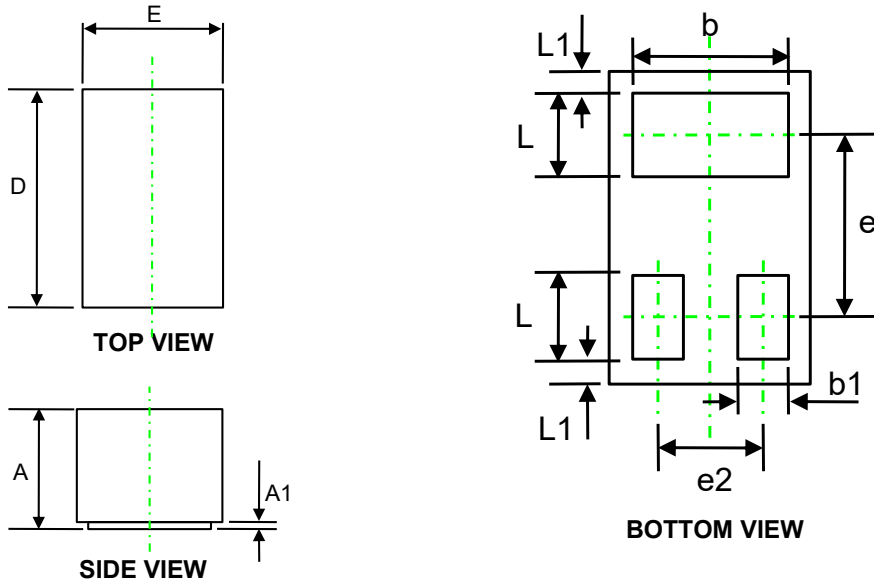

Symbol	Dimensions In Millimeters		Dimensions In Inches	
	Min.	Max.	Min.	Max.
A	0.400	0.550	0.016	0.022
A1	0.000	0.050	0.000	0.002
D	0.950	1.050	0.037	0.041
E	0.550	0.650	0.022	0.026
b	0.450	0.550	0.018	0.022
e	0.650 REF.		0.026 REF.	
e2	0.350 REF.		0.014 REF.	
L1	0.050 REF.		0.002 REF.	
L	0.200	0.300	0.008	0.012
b1	0.100	0.200	0.004	0.008

DFN1006-3L Suggested Pad Layout

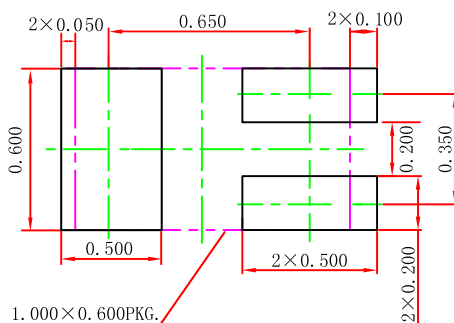

Note:

1. Controlling dimension: in millimeters.
2. General tolerance: ± 0.050 mm.
3. The pad layout is for reference purposes only.

NOTICE

JSCJ reserves the right to make modifications, enhancements, improvements, corrections or other changes without further notice to any product herein. JSCJ does not assume any liability arising out of the application or use of any product described herein.

DFN1006-3L Tape and Reel

DFN1006-3L Embossed Carrier Tape

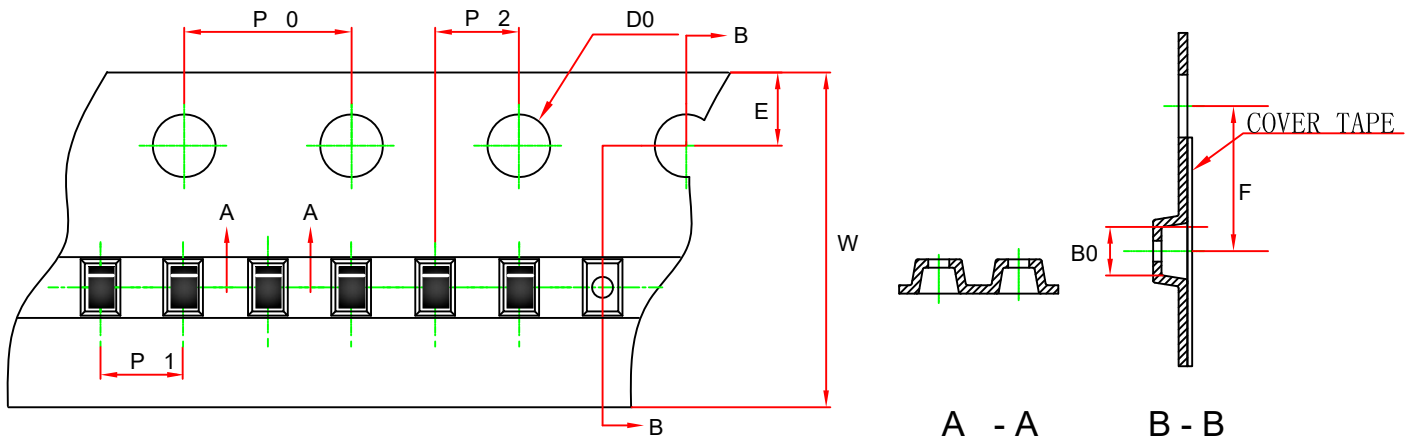

Dimensions In Millimeters (mm)								
Pkg type	B0	P0	P1	P2	E	F	W	D0
DFN1006-3L	1.11	4.00	2.00	2.00	1.75	3.50	8.00	1.55
Tolerance	+/-0.06	+/-0.1	+/-0.1	+/-0.1	+/-0.1	+/-0.1	+/-0.3	+/-0.1

DFN1006-3L Tape Leader and Trailer

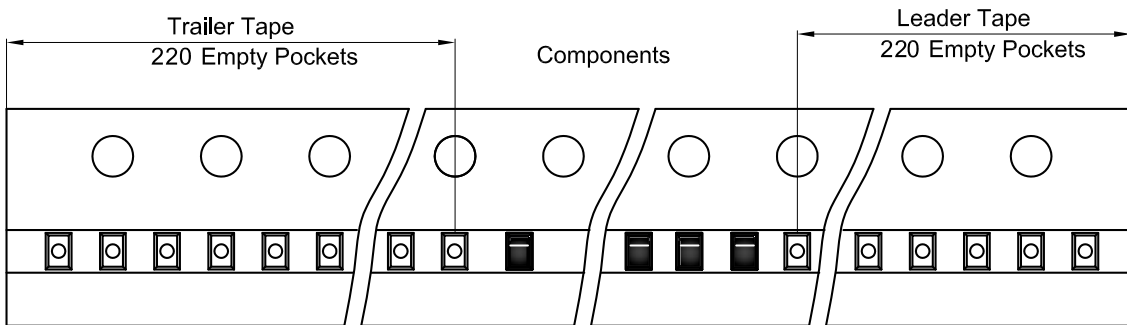

DFN1006-3L Reel

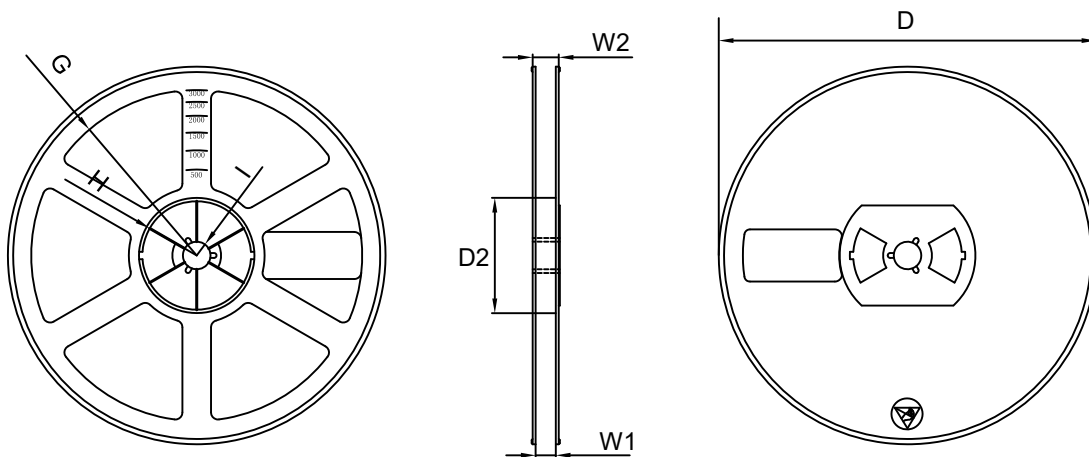

Symbol	Dimensions In Millimeters (mm)						
	D	D2	G	H	I	W1	W2
7" Dia	Φ178.00	54.50	R78.00	R25.6	R6.5	9.50	12.30
Tolerance	+/-2	+/-1	+/-1	+/-1	+/-1	+/-2	+/-1.5

REEL	Reel Size	Box	Box size(mm)	Carton	Carton Size(mm)
10000 pcs	7 inch	150000 pcs	220×220×210	600000 pcs	450×450×240