

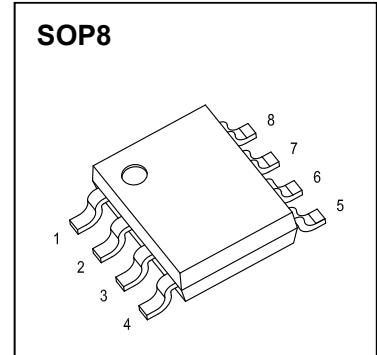

SOP8 Plastic-Encapsulate MOSFETS

CJQ4459A P-Channel Power MOSFET

$V_{(BR)DSS}$	$R_{DS(on)TYP}$	I_D
-30V	28mΩ@-10V	-6A
	40mΩ@-4.5V	



DESCRIPTION

The CJQ4459A combines advanced trench MOSFET technology with a low resistance package to provide extremely low $R_{DS(ON)}$. This device is ideal for load switch and battery protection applications.

APPLICATIONS

- Battery Switch
- Load Switch

MARKING



Q4459A= Device code
 Solid dot = Green molding compound device,
 if none, the normal device
 XX = Code

Equivalent Circuit

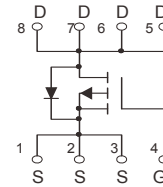

MAXIMUM RATINGS ($T_J=25^{\circ}C$ unless otherwise noted)

Parameter	Symbol	Limit	Unit
Drain-Source Voltage	V_{DS}	-30	V
Gate-Source Voltage	V_{GS}	±20	V
Continuous Drain Current	I_D ①	-6	A
Pulsed Drain Current	I_{DM} ②	-24	A
Single Pulsed Avalanche Energy	E_{AS} ③	34	mJ
Power Dissipation	P_D ⑤	2.3	W
Thermal Resistance from Junction to Ambient	$R_{\theta JA}$ ⑤	54	°C/W
Operating Junction and Storage Temperature Range	T_J, T_{STG}	-55~+150	°C

MOSFET ELECTRICAL CHARACTERISTICS

$T_J=25^{\circ}\text{C}$ unless otherwise specified

Parameter	Symbol	Test Condition	Min	Typ	Max	Unit	
Off characteristics							
Drain-source breakdown voltage	$V_{(BR)DSS}$	$V_{GS} = 0V, I_D = -250\mu A$	-30	-	-	V	
Zero gate voltage drain current	I_{DSS}	$V_{DS} = -24V, V_{GS} = 0V$	$T_J = 25^{\circ}\text{C}$	-	-	-1.0	μA
			$T_J = 125^{\circ}\text{C}$	-	-	-100	
Gate-body leakage current	I_{GSS}	$V_{DS} = 0V, V_{GS} = \pm 20V$	-	-	± 100	nA	
On characteristics ^④							
Gate-threshold voltage	$V_{GS(th)}$	$V_{DS} = V_{GS}, I_D = -250\mu A$	-1.0	-1.6	-2.5	V	
Static drain-source on-state resistance	$R_{DS(on)}$	$V_{GS} = -10V, I_D = -6A$	-	28	36	m Ω	
		$V_{GS} = -4.5V, I_D = -5A$	-	40	52	m Ω	
Dynamic characteristics							
Input capacitance	C_{iss}	$V_{DS} = -15V, V_{GS} = 0V, f = 1\text{MHz}$	-	760	-	μF	
Output capacitance	C_{oss}		-	107	-		
Reverse transfer capacitance	C_{rss}		-	66	-		
Gate resistance	R_g	$f = 1\text{MHz}$	-	12	-	Ω	
Switching characteristics							
Total gate charge	Q_g	$V_{GS} = -4.5V, V_{DD} = -15V, I_D = -6A$ $V_{GS} = -10V, V_{DD} = -15V, I_D = -6A$	-	7.0	-	nC	
Total gate charge	Q_g		-	13.4	-		
Gate-source charge	Q_{gs}		-	2.7	-		
Gate-drain charge	Q_{gd}		-	2.5	-		
Drain-Source Diode Characteristics							
Drain-source diode forward voltage	V_{SD} ^④	$V_{GS} = 0V, I_S = -2A$	-	-	-1.2	V	
Continuous drain-source diode forward current	I_S ^①		-	-	-6	A	
Pulsed drain-source diode forward current	I_{SM} ^{①②}		-	-	-24	A	

Notes:

1. $T_A = 25^{\circ}\text{C}$.

2. Limited only by maximum temperature allowed.

3. $V_{DD} = -15V, V_{GS} = -10V, L = 0.5\text{mH}, R_g = 25\Omega$ Starting $T_J = 25^{\circ}\text{C}$.

4. Pulse Test : Pulse Width $\leq 380\mu s$, duty cycle $\leq 2\%$.

5. Device mounted on 1 in² FR-4 board with 2oz. single-sided Copper, in a still air environment with $T_A = 25^{\circ}\text{C}$.

Typical Characteristics ($T_J = 25^\circ\text{C}$, unless otherwise specified)

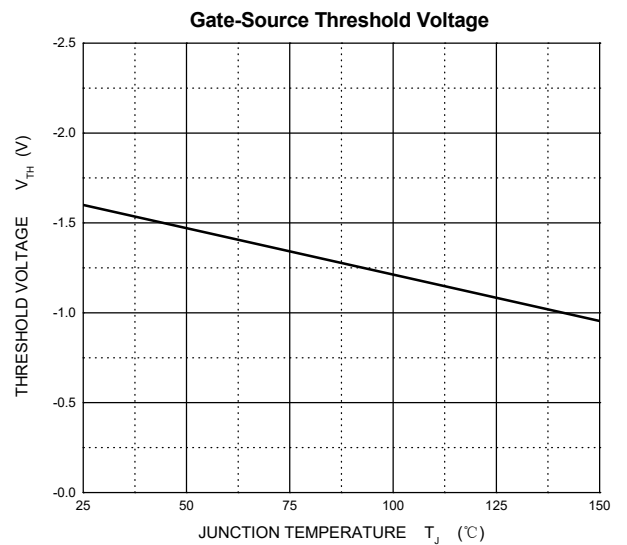
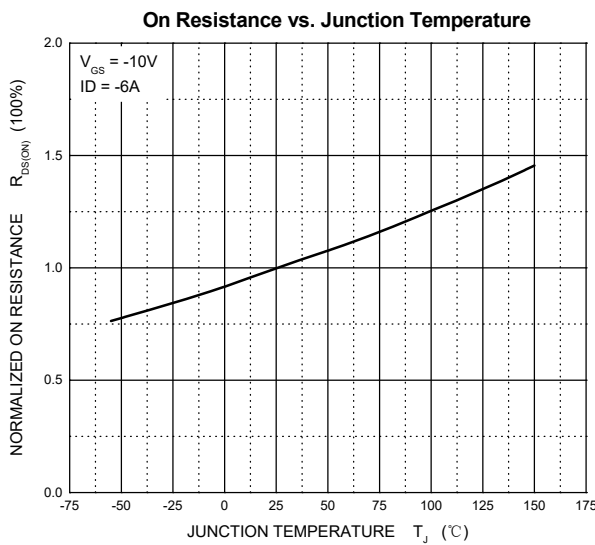
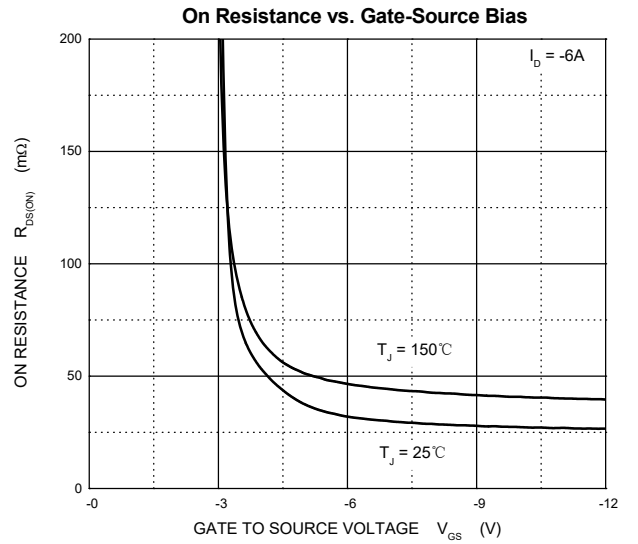
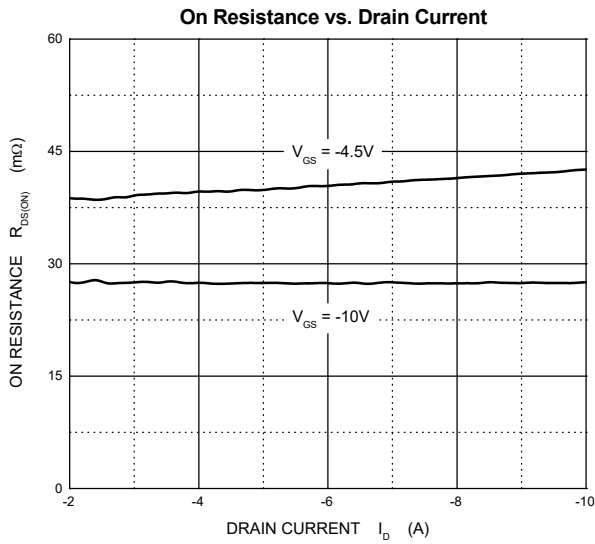
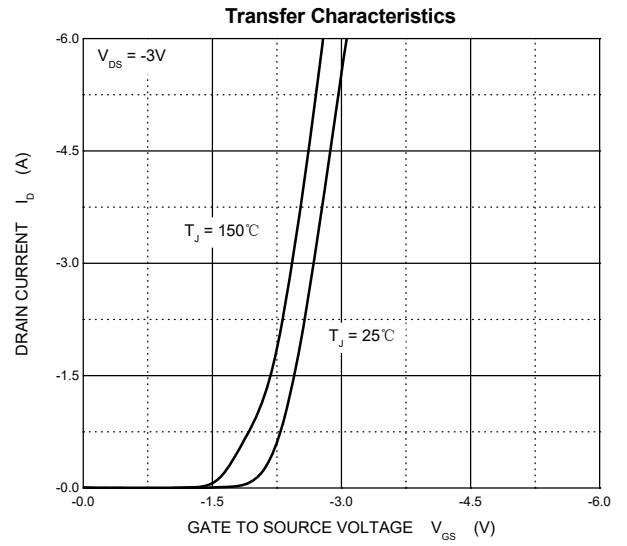
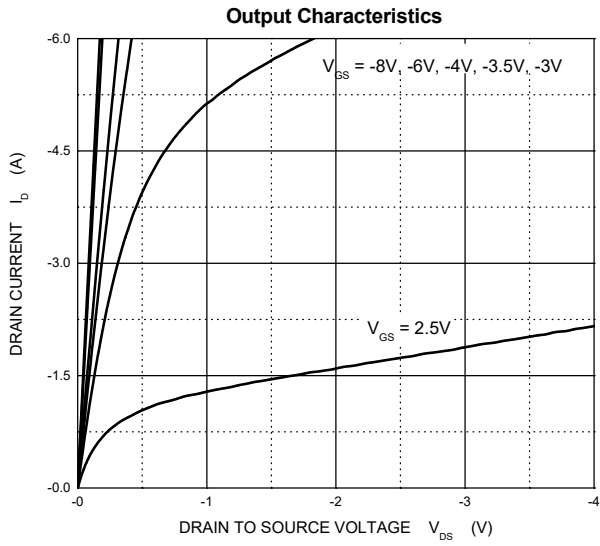

Typical Characteristics ($T_J = 25^\circ\text{C}$, unless otherwise specified)

Typical Capacitances

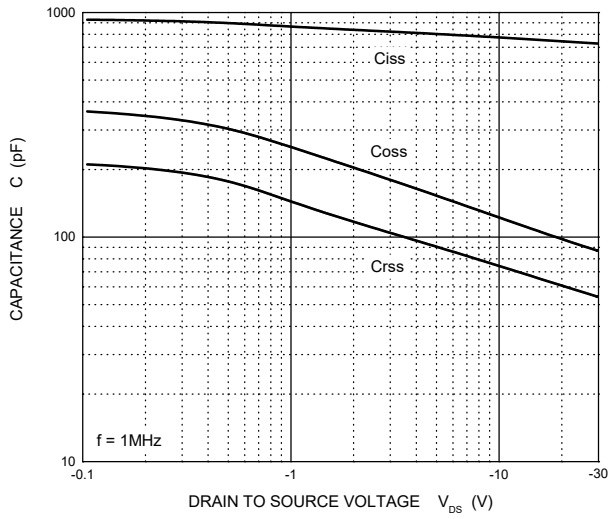

Gate Charge

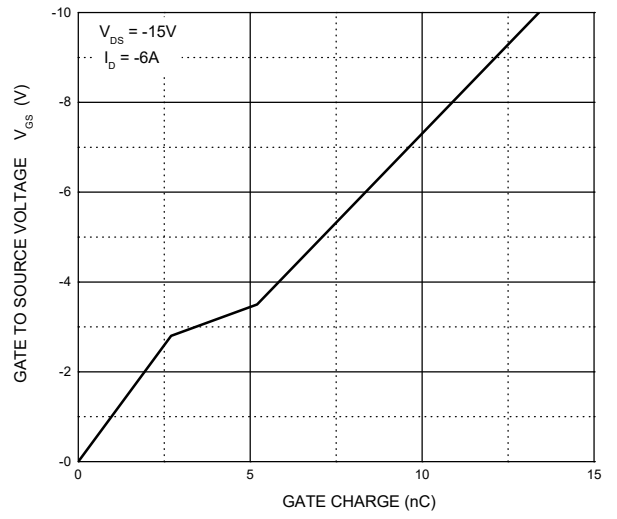

Source-Drain Diode Forward Characteristics

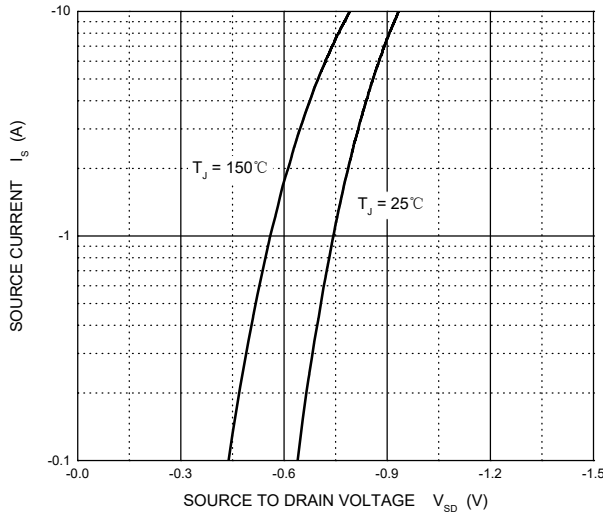

Maximum Safe Operating Area

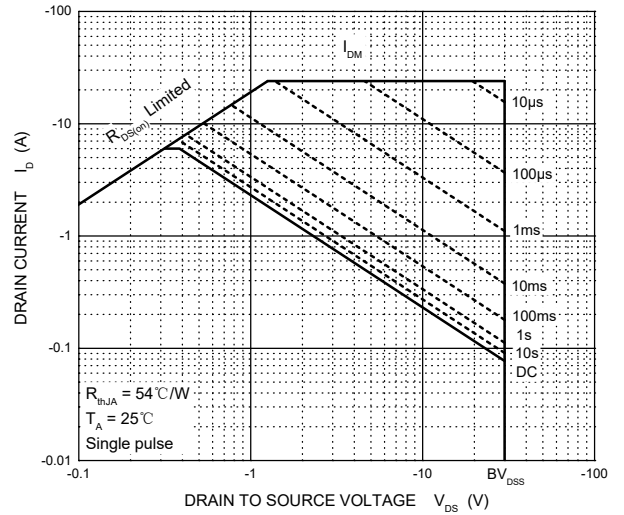

Transient Thermal Impedance, Junction-Ambient

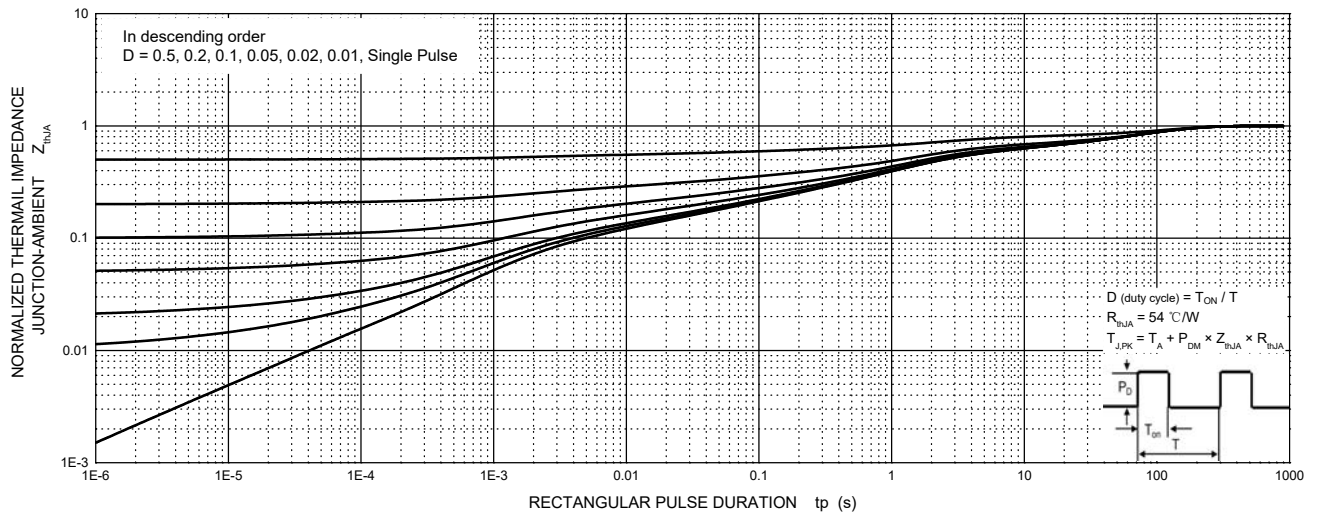

TEST CIRCUIT AND WAVEFORMS

Gate Charge

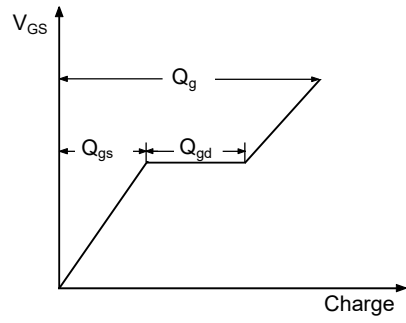

Un-clamped Inductive Load Switching

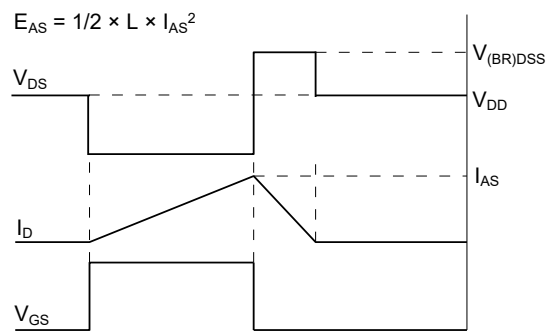
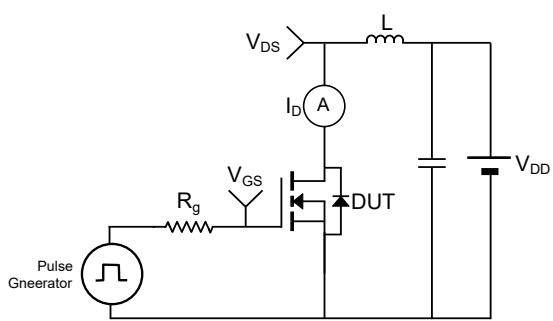

SOP8 Package Outline Dimensions

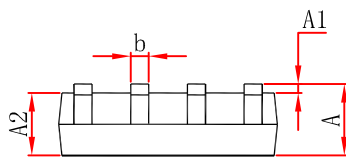
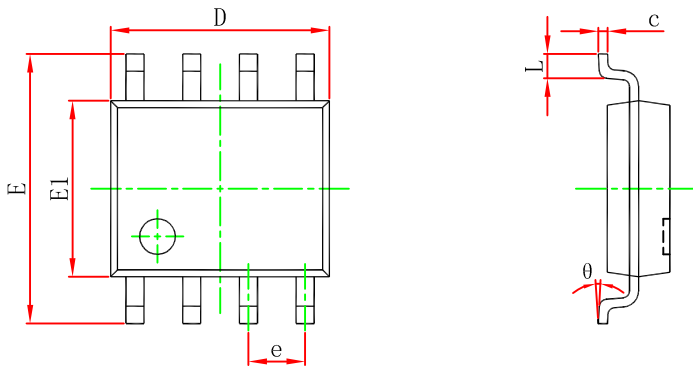

Symbol	Dimensions In Millimeters		Dimensions In Inches	
	Min	Max	Min	Max
A	1.450	1.750	0.053	0.069
A1	0.100	0.250	0.004	0.010
A2	1.350	1.550	0.053	0.061
b	0.330	0.510	0.013	0.020
c	0.170	0.250	0.007	0.010
D	4.700	5.100	0.185	0.201
e	1.270 (BSC)		0.050 (BSC)	
E	5.800	6.200	0.228	0.244
E1	3.800	4.000	0.150	0.157
L	0.400	1.270	0.016	0.050
θ	0°	8°	0°	8°

SOP8 Suggested Pad Layout

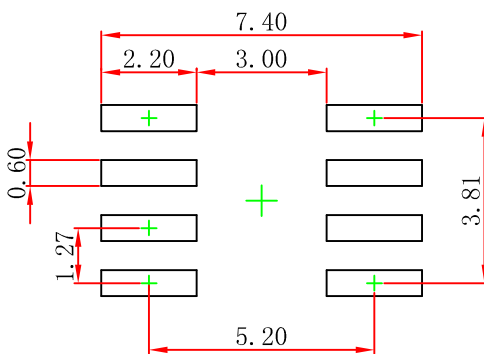

Note:

1. Controlling dimension: in millimeters.
2. General tolerance: $\pm 0.05\text{mm}$.
3. The pad layout is for reference purposes only.

NOTICE

JSCJ reserves the right to make modifications, enhancements, improvements, corrections or other changes without further notice to any product herein. JSCJ does not assume any liability arising out of the application or use of any product described herein.

SOP8 Tape and Reel

SOP8 Embossed Carrier Tape

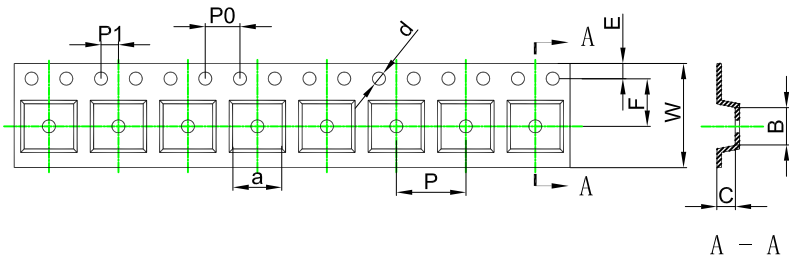

Packaging Description:

SOP8 parts are shipped in tape. The carrier tape is made from a dissipative (carbon filled) polycarbonate resin. The cover tape is a multilayer film (Heat Activated Adhesive in nature) primarily composed of polyester film, adhesive layer, sealant, and anti-static sprayed agent. These reeled parts in standard option are shipped with 2,500 units per 13" or 33cm diameter reel. The reels are clear in color and is made of polystyrene plastic (anti-static coated).

ALL DIM IN mm

Dimensions are in millimeter										
Pkg type	a	B	C	d	E	F	P0	P	P1	W
SOP8	6.40	5.40	2.10	Ø1.50	1.75	5.50	4.00	8.00	2.00	12.00

SOP8 Tape Leader and Trailer

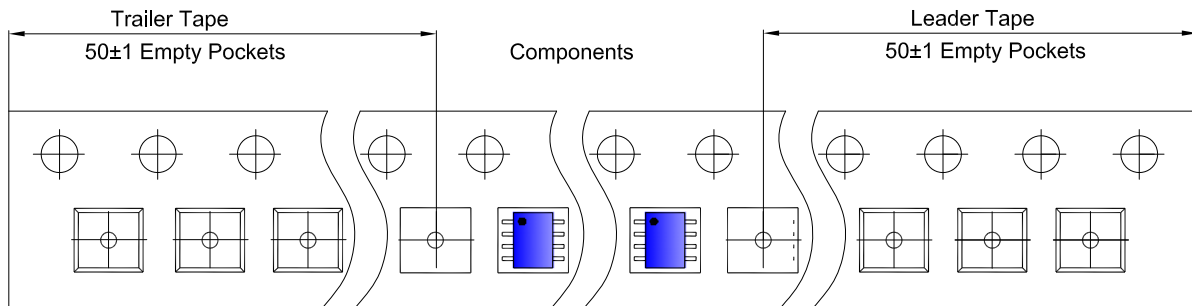

SOP8 Reel

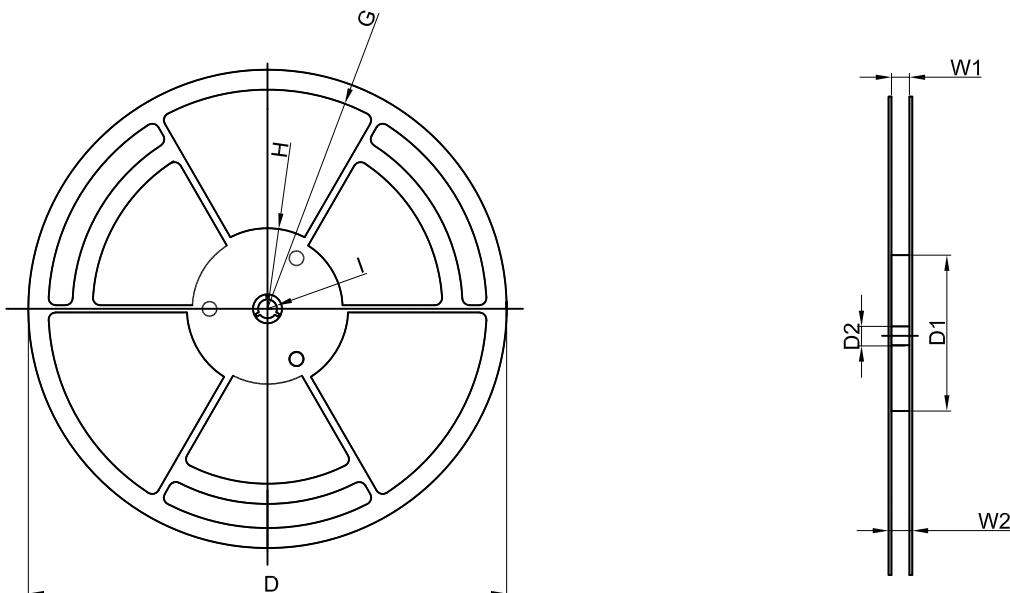

Dimensions are in millimeter								
Reel Option	D	D1	D2	G	H	I	W1	W2
13" Dia	Ø330.00	100.00	13.00	R151.00	R56.00	R6.50	12.40	17.60

REEL	Reel Size	Box	Box Size(mm)	Carton	Carton Size(mm)	G.W.(kg)
4,000 pcs	13 inch	8,000 pcs	360×360×65	40,000 pcs	565×380×390	