

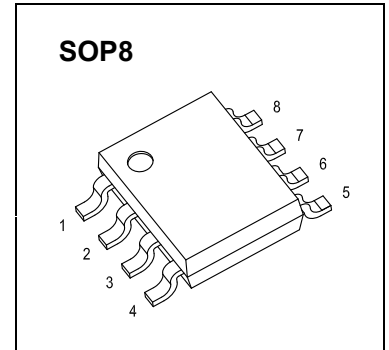

SOP8 Plastic-Encapsulate MOSFETS

CJQ4828 Dual N-Channel MOSFET

$V_{(BR)DSS}$	$R_{DS(on)MAX}$	I_D
60V	56mΩ@10V	4.5A
	77mΩ@4.5V	



DESCRIPTION

The CJQ4828 uses advanced trench technology to provide excellent $R_{DS(ON)}$ and low gate charge. This device is suitable for use as a load switch or in PWM applications.

MARKING:

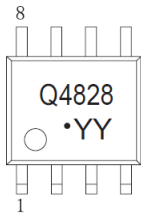

Q4828= Device code
 YY=Date Code
 Solid dot = Pin1 indicator
 Solid dot = Green molding compound device, if none,the normal device.

Equivalent Circuit

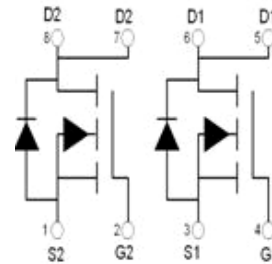

Maximum ratings ($T_a=25^{\circ}C$ unless otherwise noted)

Parameter	Symbol	Value	Units
Drain-Source Voltage	V_{DS}	60	V
Gate-Source Voltage	V_{GS}	± 20	V
Continuous Drain Current (t \leq 10s) (note 1)	I_D	4.5	A
Pulsed Drain Current (note 2)	I_{DM}	20	A
Power Dissipation	P_D	1.25	W
Thermal Resistance from Junction to Ambient (t \leq 10s) (note 1)	$R_{\theta JA}$	100	$^{\circ}C/W$
Avalanche Current (note 2)	I_{AR}, I_{AS}	19	A
Repetitive Avalanche Energy 0.1mH (note 2)	E_{AR}, E_{AS}	18	mJ
Junction Temperature	T_J	150	$^{\circ}C$
Storage Temperature	T_{STG}	-55~ 150	$^{\circ}C$

MOSFET ELECTRICAL CHARACTERISTICS

$T_a=25\text{ }^\circ\text{C}$ unless otherwise specified

Parameter	Symbol	Test Condition	Min	Typ	Max	Unit
STATIC PARAMETERS						
Drain-source breakdown voltage	$V_{(BR)DSS}$	$V_{GS} = 0V, I_D = 250\mu A$	60			V
Zero gate voltage drain current	I_{DSS}	$V_{DS} = 60V, V_{GS} = 0V$			1	μA
Gate-body leakage current	I_{GSS}	$V_{GS} = \pm 20V, V_{DS} = 0V$			± 100	nA
Gate threshold voltage (note 3)	$V_{GS(th)}$	$V_{DS} = V_{GS}, I_D = 250\mu A$	1	2.1	3	V
Drain-source on-resistance (note 3)	$R_{DS(on)}$	$V_{GS} = 10V, I_D = 4.5A$		40	56	m Ω
		$V_{GS} = 4.5V, I_D = 3A$		55	77	m Ω
Forward tranconductance (note 3)	g_{FS}	$V_{DS} = 5V, I_D = 4.5A$	6			S
Diode forward voltage (note 3)	V_{SD}	$I_S = 1A, V_{GS} = 0V$			1	V
DYNAMIC PARAMETERS (note 4)						
Input Capacitance	C_{iss}	$V_{DS} = 30V, V_{GS} = 0V, f = 1MHz$			540	pF
Output Capacitance	C_{oss}			60		pF
Reverse Transfer Capacitance	C_{rss}			25		pF
SWITCHING PARAMETERS (note 4)						
Turn-on delay time	$t_{d(on)}$	$V_{GS} = 10V, V_{DS} = 30V,$ $R_L = 6.7\Omega, R_{GEN} = 3\Omega$		4.7		ns
Turn-on rise time	t_r			2.3		ns
Turn-off delay time	$t_{d(off)}$			15.7		ns
Turn-off fall time	t_f			1.9		ns
Total Gate Charge (10V)	Q_g	$V_{DS} = 30V, V_{GS} = 10V, I_D = 4.5A$			10.5	nC
Total Gate Charge (4.5V)					5.5	nC
Gate-Source Charge	Q_{gs}			1.6		nC
Gate-Drain Charge	Q_{gd}			2.2		nC

Notes :

1. The value in any given application depends on the user's specific board design.
2. Repetitive rating : Pulse width limited by junction temperature.
3. Pulse Test : Pulse Width $\leq 300\mu s$, Duty Cycle $\leq 0.5\%$.
4. These parameters have no way to verify.

Typical Characteristics

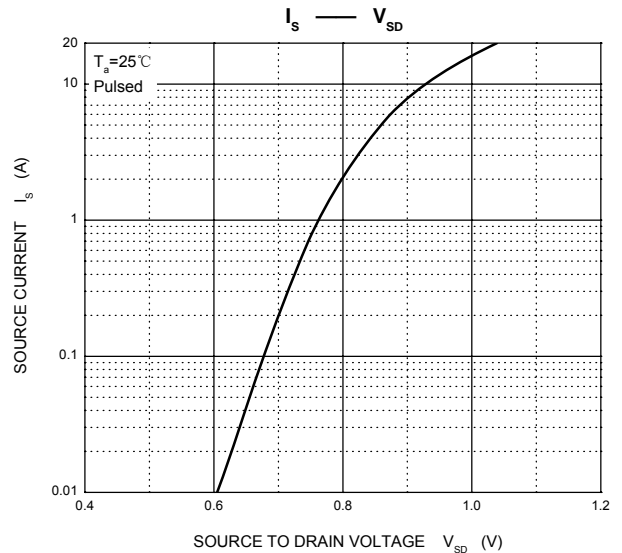
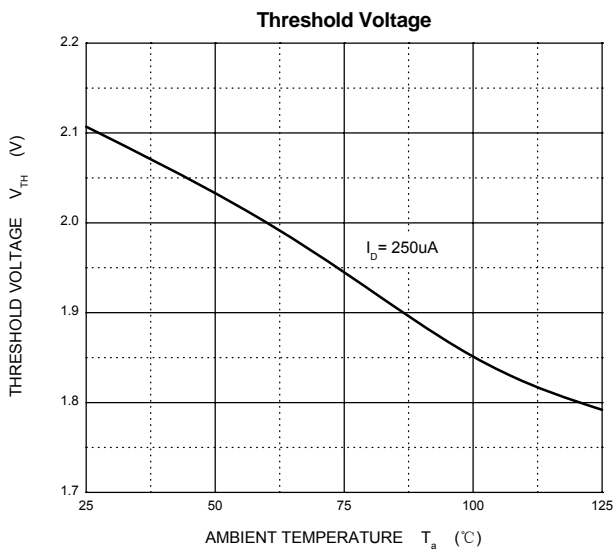
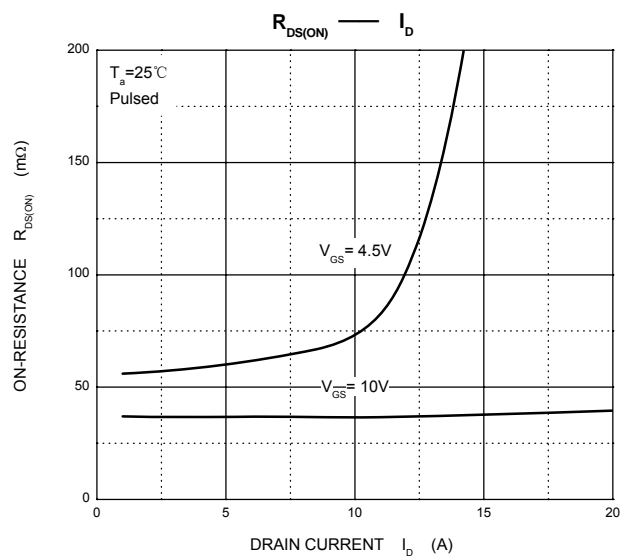
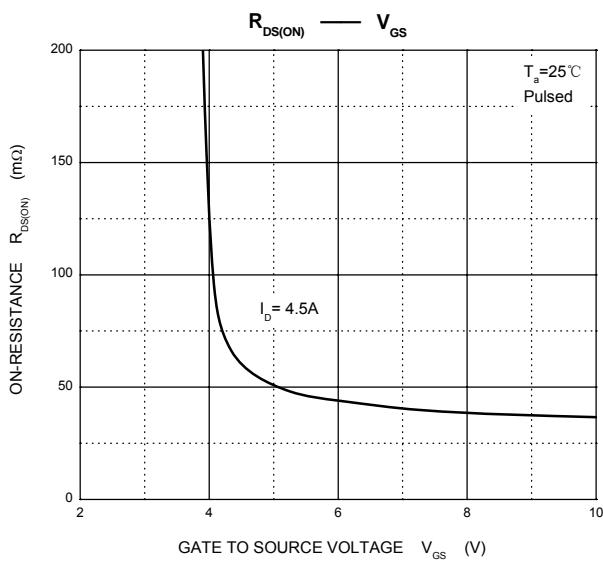
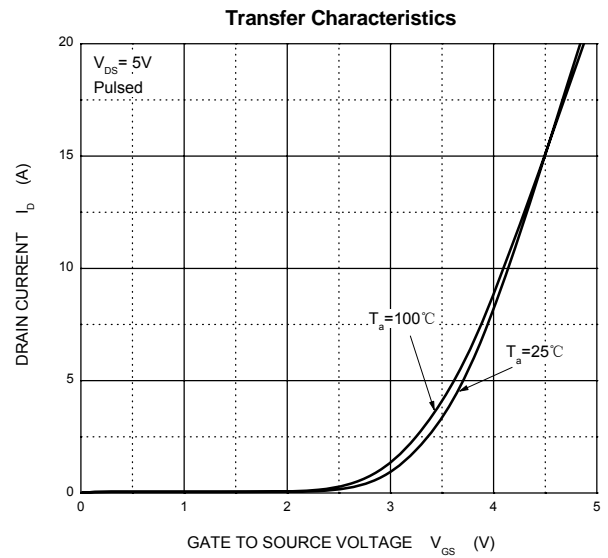
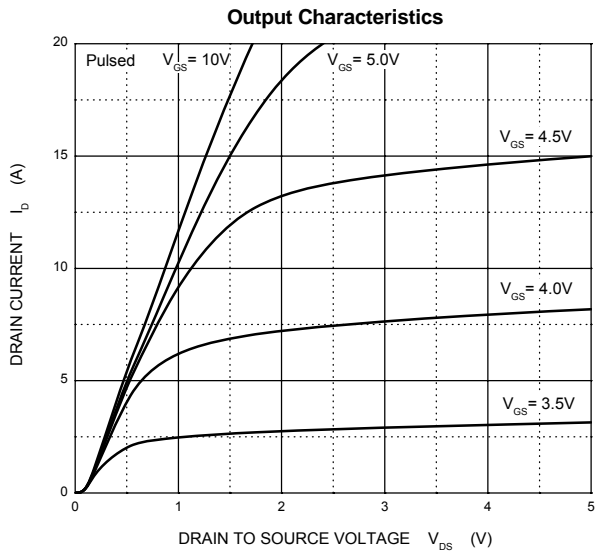

SOP8 Package Outline Dimensions

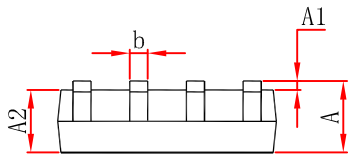
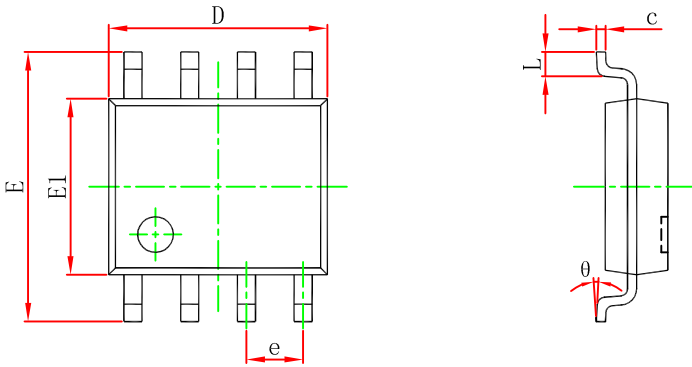

Symbol	Dimensions In Millimeters		Dimensions In Inches	
	Min	Max	Min	Max
A	1.450	1.750	0.053	0.069
A1	0.100	0.250	0.004	0.010
A2	1.350	1.550	0.053	0.061
b	0.330	0.510	0.013	0.020
c	0.170	0.250	0.007	0.010
D	4.700	5.100	0.185	0.201
e	1.270 (BSC)		0.050 (BSC)	
E	5.800	6.200	0.228	0.244
E1	3.800	4.000	0.150	0.157
L	0.400	1.270	0.016	0.050
theta	0°	8°	0°	8°

SOP8 Suggested Pad Layout

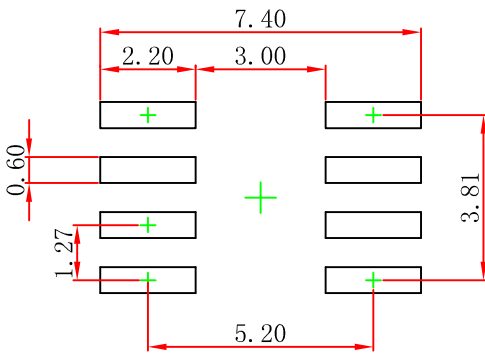

Note:

1. Controlling dimension: in millimeters.
2. General tolerance: $\pm 0.05\text{mm}$.
3. The pad layout is for reference purposes only.

NOTICE

JSCJ reserves the right to make modifications, enhancements, improvements, corrections or other changes without further notice to any product herein. JSCJ does not assume any liability arising out of the application or use of any product described herein.

SOP8 Tape and Reel

SOP8 Embossed Carrier Tape

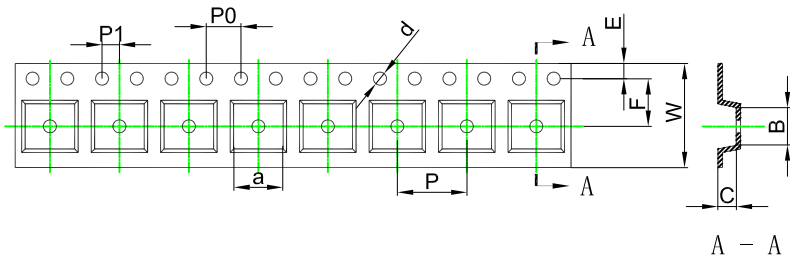

Packaging Description:

SOP8 parts are shipped in tape. The carrier tape is made from a dissipative (carbon filled) polycarbonate resin. The cover tape is a multilayer film (Heat Activated Adhesive in nature) primarily composed of polyester film, adhesive layer, sealant, and anti-static sprayed agent. These reeled parts in standard option are shipped with 4,000 units per 13" or 33cm diameter reel. The reels are clear in color and is made of polystyrene plastic (anti-static coated).

ALL DIM IN mm

Dimensions are in millimeter										
Pkg type	a	B	C	d	E	F	P0	P	P1	W
SOP8	6.40	5.40	2.10	Ø1.50	1.75	5.50	4.00	8.00	2.00	12.00

SOP8 Tape Leader and Trailer

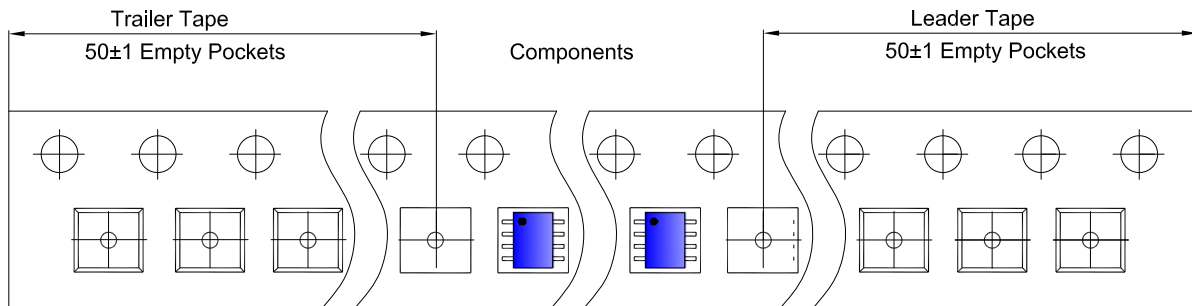

SOP8 Reel

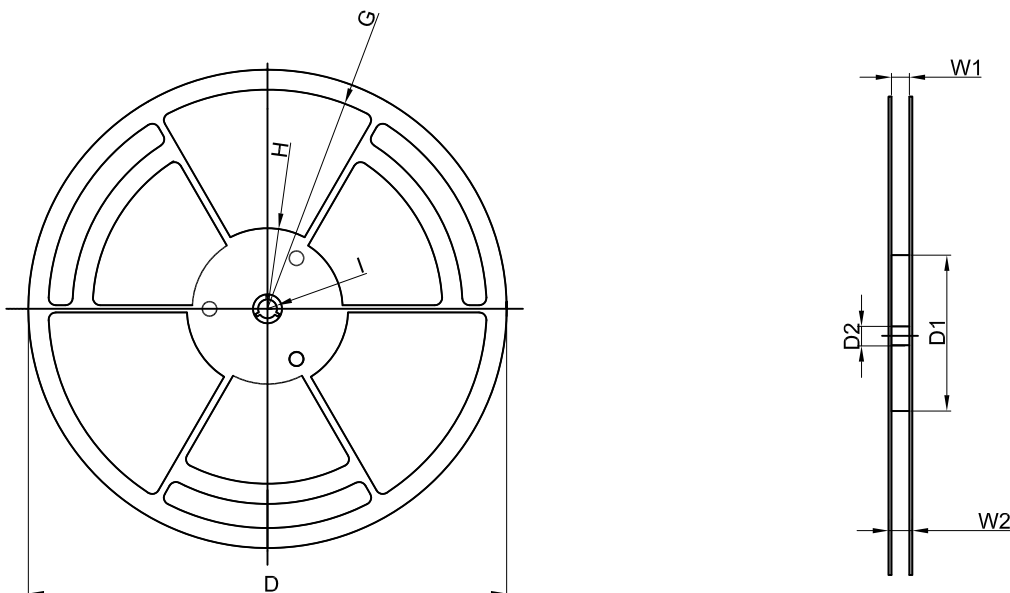

Dimensions are in millimeter								
Reel Option	D	D1	D2	G	H	I	W1	W2
13" Dia	Ø330.00	100.00	13.00	R151.00	R56.00	R6.50	12.40	17.60

REEL	Reel Size	Box	Box Size(mm)	Carton	Carton Size(mm)	G.W.(kg)
4,000 pcs	13 inch	8,000 pcs	360×360×65	40,000 pcs	565×380×390	