

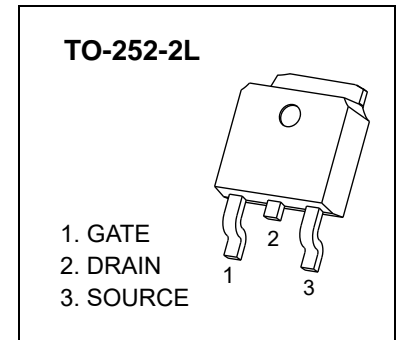

## TO-252-2L Plastic-Encapsulate MOSFETS

### CJU04N50M1 N-Channel Power MOSFET

$V_{(BR)DSS}$	$R_{DS(on)TYP}$	$I_D$
500V	1.2Ω@10V	4A



#### GENERAL DESCRIPTION

The CJU04N50M1 is an N-channel mode power MOSFET using advanced technology to provide customers with planar stripe. This technology specializes in allowing a minimum on-state resistance and superior switching performance. It also can withstand high energy pulse in the avalanche and commutation mode. The CJU04N50M1 is universally applied in high efficiency switch mode power supply.

#### FEATURE

- Excellent package for good heat dissipation
- High switching speed
- 100% avalanche tested

#### APPLICATION

- Power switching application
- DC/DC converters

#### MARKING

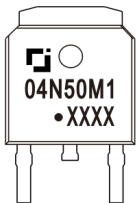

04N50M1= Device code.  
 Solid dot = Green molding compound device,  
 if none, the normal device  
 XXXX=Code

#### EQUIVALENT CIRCUIT

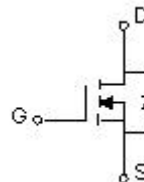

#### Maximum ratings ( $T_J=25^{\circ}C$ unless otherwise noted)

Parameter	Symbol	Value	Unit
Drain-Source Voltage	$V_{DS}$	500	V
Gate-Source Voltage	$V_{GS}$	±30	
Continuous Drain Current	$I_D^{①}$	4	A
Pulsed Drain Current	$I_{DM}^{①②}$	16	
Single Pulsed Avalanche Energy	$E_{AS}^{③}$	180	mJ
Power Dissipation	$P_D^{①}$	104	W
Thermal Resistance from Junction to Ambient	$R_{\theta JA}^{⑥}$	62.5	°C/W
Thermal Resistance from Junction to Case	$R_{\theta JC}^{①}$	1.2	°C/W
Operating Junction and Storage Temperature Range	$T_J, T_{STG}$	-55 ~+150	°C

# MOSFET ELECTRICAL CHARACTERISTICS

$T_J=25^{\circ}\text{C}$  unless otherwise specified

Parameter	Symbol	Test Condition	Min	Typ	Max	Unit	
<b>Off characteristics</b>							
Drain-source breakdown voltage	$V_{(BR)DSS}$	$V_{GS} = 0V, I_D = 250\mu A$	500	-	-	V	
Zero gate voltage drain current	$I_{DSS}$	$V_{DS} = 500V, V_{GS} = 0V$	$T_J = 25^{\circ}\text{C}$	-	-	1.0	$\mu A$
			$T_J = 125^{\circ}\text{C}$	-	-	100	
Gate-body leakage current	$I_{GSS}$	$V_{DS} = 0V, V_{GS} = \pm 30V$	-	-	$\pm 100$	nA	
<b>On characteristics</b> <sup>④</sup>							
Gate-threshold voltage	$V_{GS(th)}$	$V_{DS} = V_{GS}, I_D = 250\mu A$	2.0	3.0	4.0	V	
Static drain-source on-resistance	$R_{DS(on)}$	$V_{GS} = 10V, I_D = 2A$	-	1.2	1.5	$\Omega$	
<b>Dynamic characteristics</b> <sup>⑤</sup>							
Input capacitance	$C_{iss}$	$V_{DS} = 50V, V_{GS} = 0V, f = 1\text{MHz}$	-	639	-	$\mu F$	
Output capacitance	$C_{oss}$		-	41	-		
Reverse transfer capacitance	$C_{rss}$		-	2	-		
Gate resistance	$R_g$	$f = 1\text{MHz}$	-	3.0	-	$\Omega$	
<b>Switching characteristics</b> <sup>⑤</sup>							
Total gate charge	$Q_g$	$V_{DS} = 400V, V_{GS} = 6V, I_D = 4A$	-	6	-	nC	
Total gate charge	$Q_g$	$V_{DS} = 400V, V_{GS} = 10V, I_D = 4A$	-	10	-		
Gate-source charge	$Q_{gs}$		-	3.5	-		
Gate-drain charge	$Q_{gd}$		-	2.5	-		
Turn-on delay time	$t_{d(on)}$	$V_{DD} = 250V, V_{GS} = 10V, R_G = 10\Omega, I_D = 4A$	-	7.2	-	ns	
Turn-on rise time	$t_r$		-	5.5	-		
Turn-off delay time	$t_{d(off)}$		-	13.3	-		
Turn-off fall time	$t_f$		-	6.2	-		
<b>Drain-Source Diode Characteristics</b>							
Drain-source diode forward voltage	$V_{SD}$ <sup>④</sup>	$V_{GS} = 0V, I_S = 7A$	-	-	1.2	V	
Maximum continuous drain-source diode forward current	$I_S$ <sup>①</sup>		-	-	4	A	
Maximum pulsed drain-source diode forward current	$I_{SM}$ <sup>①②</sup>		-	-	16	A	
Reverse recovery time	$t_{rr}$	$dI_F/dt = 100A/\mu s, I_S = 10A, V_{DD} = 50V$	-	293	-	ns	
Reverse recovery charge	$Q_{rr}$		-	2375	-	nC	

## Notes :

- $T_C = 25^{\circ}\text{C}$  Limited only by maximum temperature allowed.
- $P_w \leq 10\mu s$ , Duty cycle  $\leq 1\%$ .
- EAS condition:  $V_{DD} = 50V, V_{GS} = 10V, L = 10\text{mH}, R_g = 25\Omega$  Starting  $T_J = 25^{\circ}\text{C}$ .
- Pulse Test : Pulse Width  $\leq 300\mu s$ , duty cycle  $\leq 2\%$ .
- Guaranteed by design, not subject to production.
- Device mounted on 1 in<sup>2</sup> FR-4 board with 2oz. single-sided Copper, in a still air environment with  $T_A = 25^{\circ}\text{C}$ .

# Typical Characteristics ( $T_J = 25^\circ\text{C}$ , unless otherwise specified)

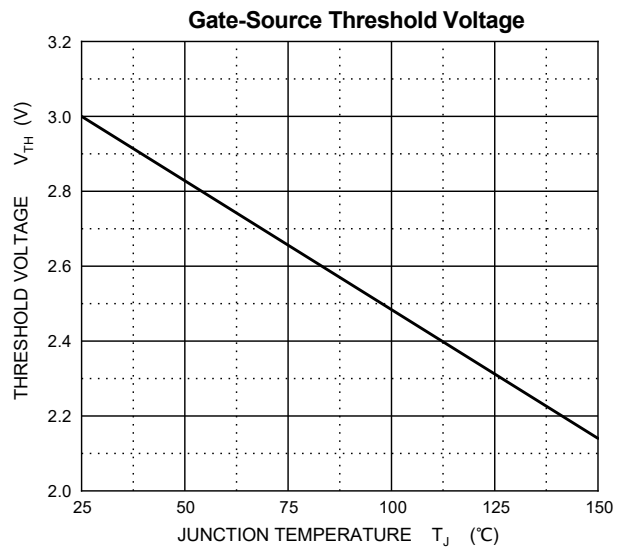
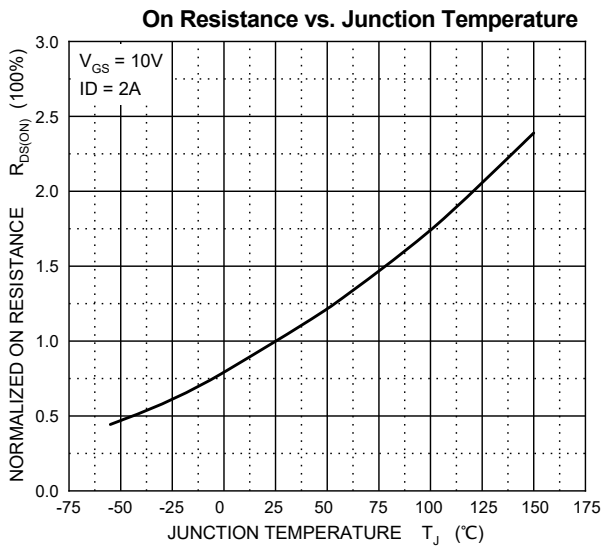
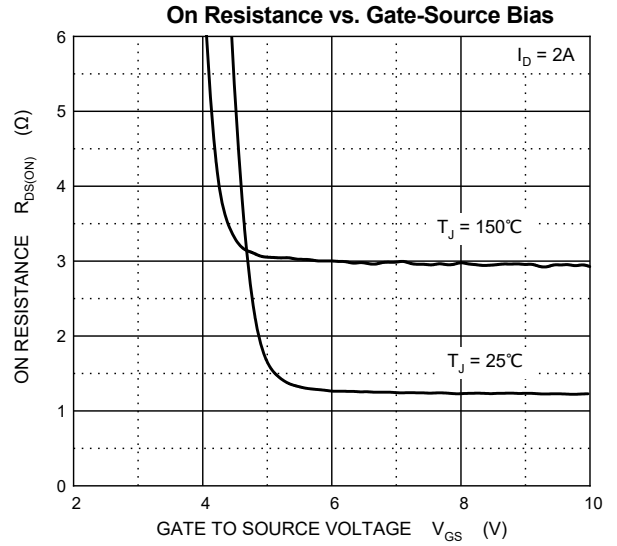
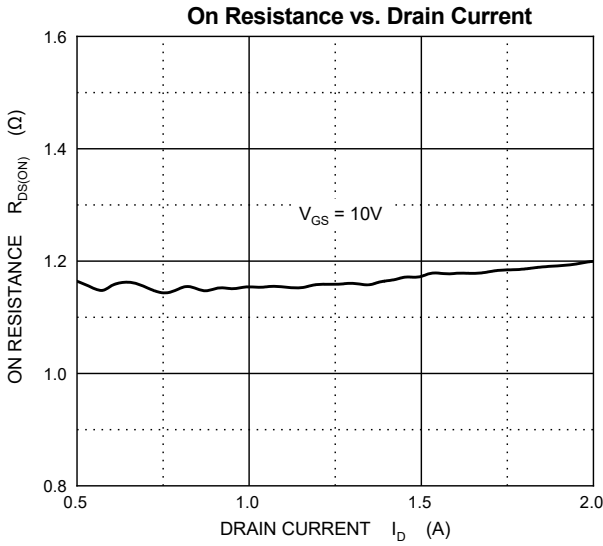
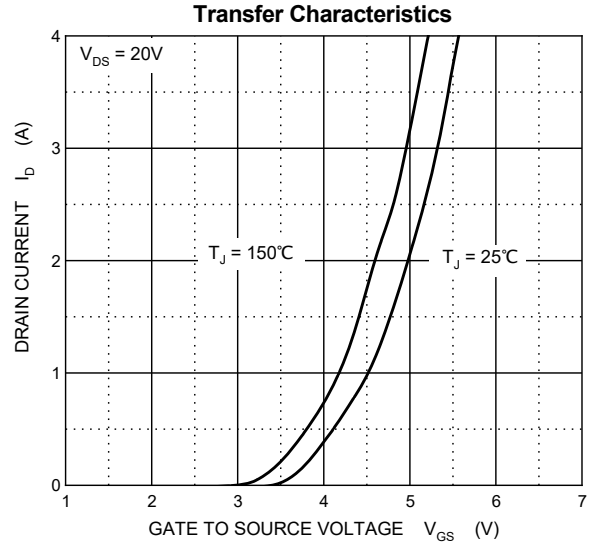
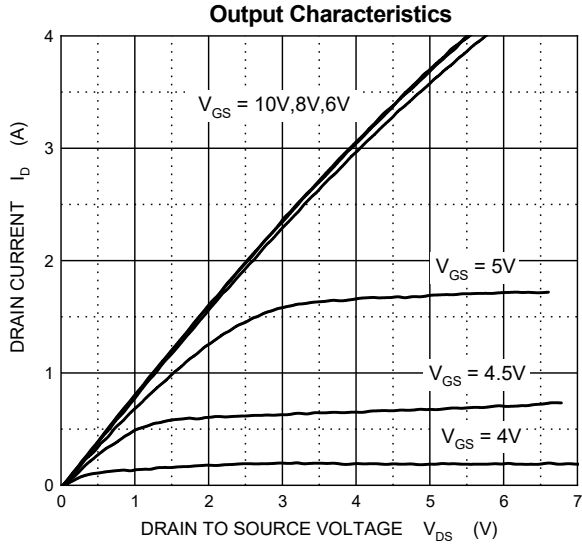

# Typical Characteristics (T<sub>J</sub> = 25°C, unless otherwise specified)

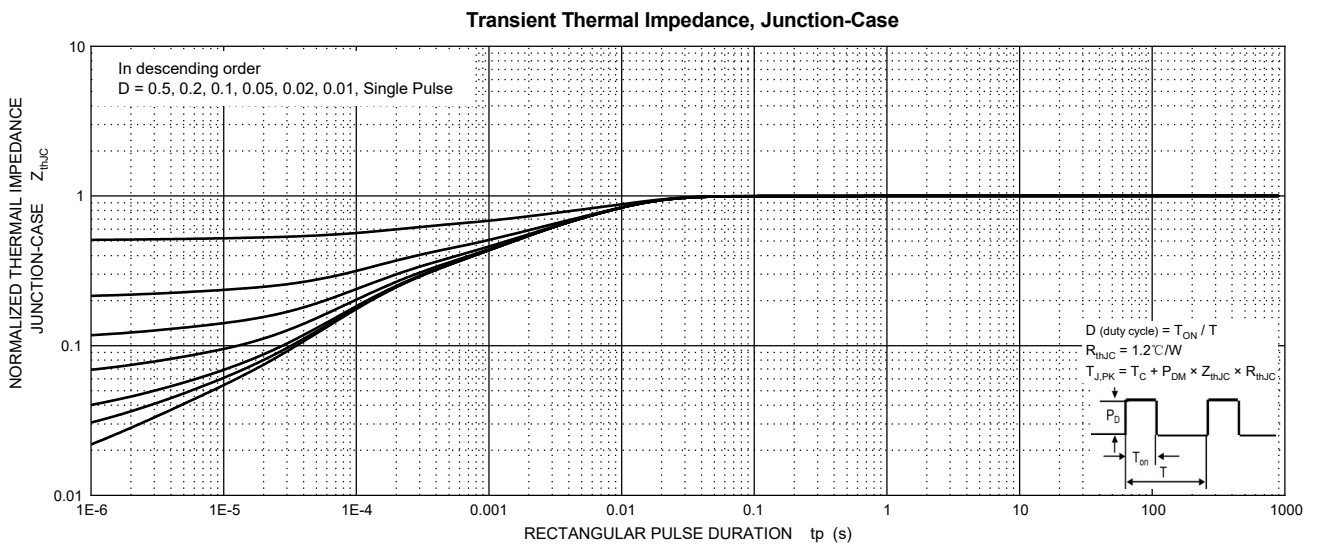
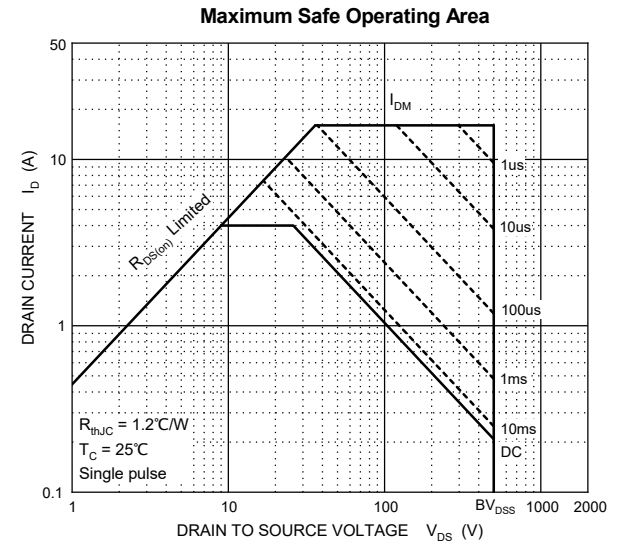
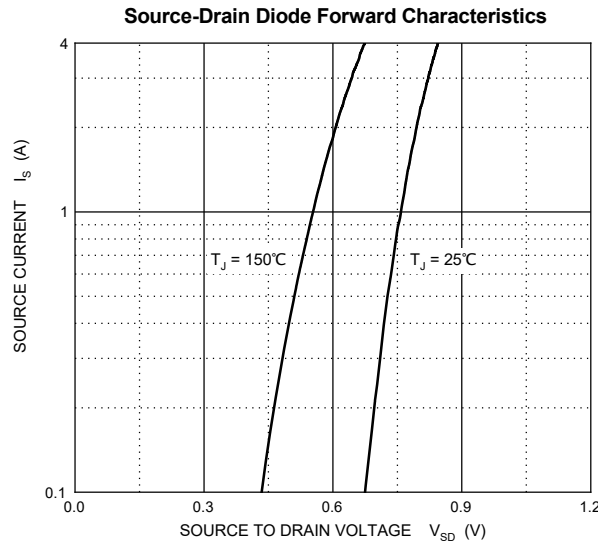
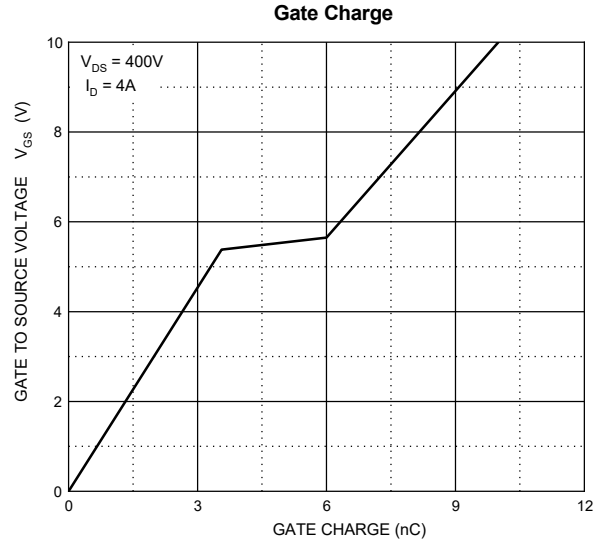
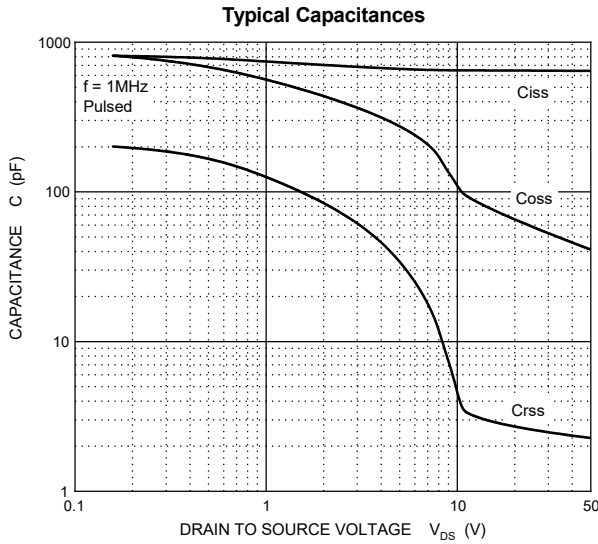

## TO-252-2L Package Outline Dimensions

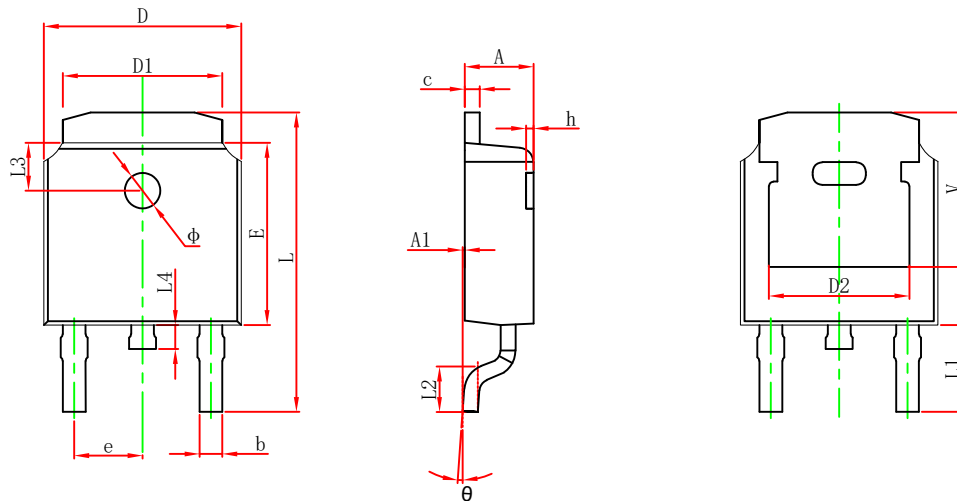

Symbol	Dimensions In Millimeters		Dimensions In Inches	
	Min.	Max.	Min.	Max.
A	2.200	2.400	0.087	0.094
A1	0.000	0.127	0.000	0.005
b	0.635	0.770	0.025	0.030
c	0.460	0.580	0.018	0.023
D	6.500	6.700	0.256	0.264
D1	5.100	5.460	0.201	0.215
D2	4.830 REF.		0.190 REF.	
E	6.000	6.200	0.236	0.244
e	2.186	2.386	0.086	0.094
L	9.712	10.312	0.382	0.406
L1	2.900 REF.		0.114 REF.	
L2	1.400	1.700	0.055	0.067
L3	1.600 REF.		0.063 REF.	
L4	0.600	1.000	0.024	0.039
$\Phi$	1.100	1.300	0.043	0.051
$\theta$	0°	8°	0°	8°
h	0.000	0.300	0.000	0.012
V	5.250 REF.		0.207 REF.	

## TO-252-2L Suggested Pad Layout

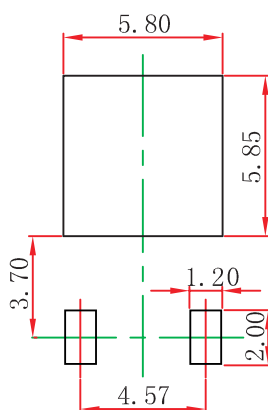

- Note:
1. Controlling dimension: in millimeters.
  2. General tolerance:  $\pm 0.05$  mm.
  3. The pad layout is for reference purposes only.

### NOTICE

JSCJ reserves the right to make modifications, enhancements, improvements, corrections or other changes without further notice to any product herein. JSCJ does not assume any liability arising out of the application or use of any product described herein.

# TO-252-2L Tape and Reel

## TO-252-2L Embossed Carrier Tape



### Packaging Description:

TO-252-2L parts are shipped in tape. The carrier tape is made from a dissipative (carbon filled) polycarbonate resin. The cover tape is a multilayer film (Hear Activated Adhesive in nature) primarily composed of polyester film, adhesive layer, sealant, and anti-static sprayed agent. These reeled parts in standard option are shipped with 2500 units per 13" or 33.0 cm diameter reel. The reels are clear in color and is made of polystyrene plastic (anti-static coated).

Dimensions are in millimeter										
Pkg type	A	B	C	d	E	F	P0	P	P1	W
TO-252	6.90	10.50	2.70	Φ1.55	1.75	7.50	4.00	8.00	2.00	16.00

## TO-252-2L Tape Leader and Trailer

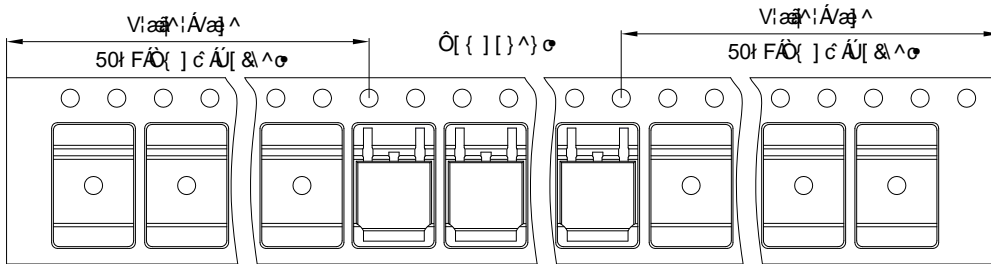

## TO-252-2L Reel

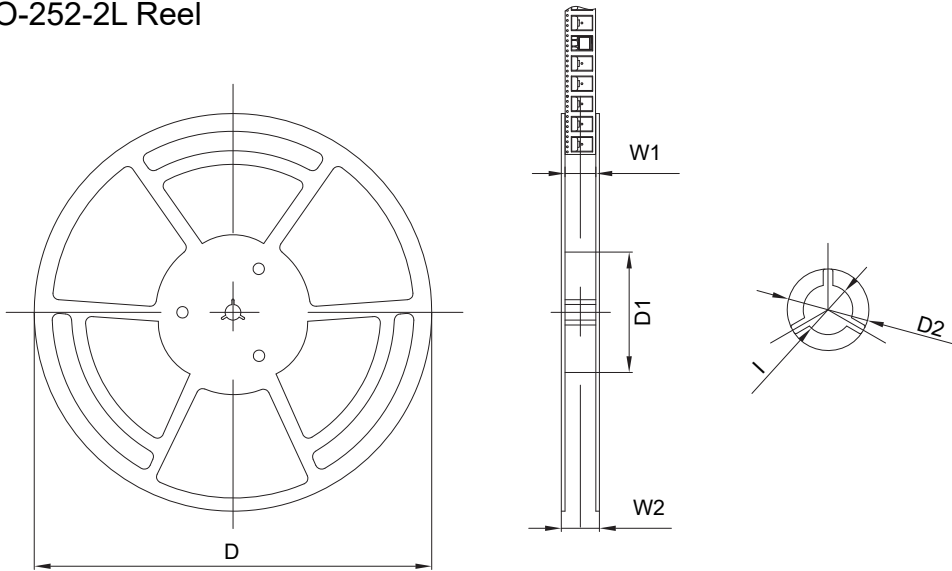

Dimensions are in millimeter						
Reel	D	D1	D2	W1	W2	l
13" Dia	330.00	100.00	Φ21.00	16.40	21.40	Φ13.00

Reel	Reel Size	Box	Box Size(mm)	Carton	Carton Size(mm)
2500 pcs	13 inch	5000 pcs	360×360×65	25000 pcs	378×358×382