



## TO-252-2L Plastic-Encapsulate MOSFETS

### CJU12P10 P-Channel Power MOSFET

$V_{(BR)DSS}$	$R_{DS(on)}$ TYP	$I_D$
-100V	195mΩ@-10V	-12A
	220mΩ@-4.5V	

#### GENERAL DESCRIPTION

The CJU12P10 uses advanced trench technology and design to provide excellent  $R_{DS(on)}$  with low gate charge. It can be used in a wide variety of applications. It is ESD protected.

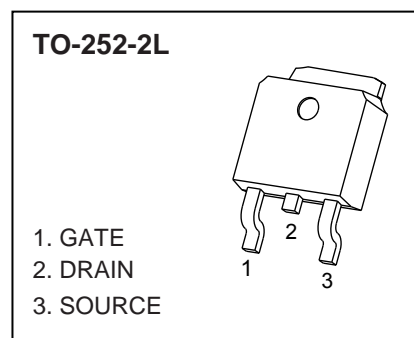

#### FEATURE

- $V_{DS} = -100V, I_D = -12A$   
 $R_{DS(on)} < 250m\Omega @ V_{GS} = -10V$  (Typ: 195mΩ)
- ESD Protection
- Advanced trench process technology
- Reliable and rugged
- High density cell design for ultra low On-Resistance

#### APPLICATION

- Power management in notebook computer
- Portable equipment and battery powered systems

#### MARKING

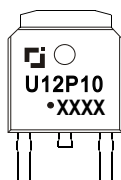

U12P10 = Device code.  
Solid dot = Green molding compound device,  
if none, the normal device.  
XXXX = Code.

#### EQUIVALENT CIRCUIT

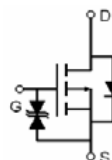

#### Maximum ratings ( $T_a = 25^\circ C$ unless otherwise noted)

Parameter	Symbol	Value	Unit
Drain-Source Voltage	$V_{DS}$	-100	V
Gate-Source Voltage	$V_{GS}$	±20	
Continuous Drain Current	$I_D$	-12	A
Pulsed Drain Current	$I_{DM}$	-48	
Single Pulsed Avalanche Energy (note1)	$E_{AS}$	49	mJ
Thermal Resistance from Junction to Ambient	$R_{\theta JA}$	100	°C/W
Junction Temperature	$T_J$	150	°C
Storage Temperature Range	$T_{STG}$	-55 ~ +150	
Maximum lead temperature for soldering purposes , 1/8" from case for 5 seconds	$T_L$	260	

## MOSFET ELECTRICAL CHARACTERISTICS

$T_a=25^\circ\text{C}$  unless otherwise specified

Parameter	Symbol	Test Condition	Min	Typ	Max	Unit
<b>Off characteristics</b>						
Drain-source breakdown voltage	$V_{(BR)DSS}$	$V_{GS} = 0V, I_D = -250\mu A$	-100			V
Zero gate voltage drain current	$I_{DSS}$	$V_{DS} = -100V, V_{GS} = 0V$			-1	$\mu A$
Gate-body leakage current	$I_{GSS}$	$V_{DS} = 0V, V_{GS} = \pm 20V$			$\pm 10$	$\mu A$
<b>On characteristics (note2)</b>						
Gate-threshold voltage	$V_{GS(th)}$	$V_{DS} = V_{GS}, I_D = -250\mu A$	-1	-2.1	-3	V
Static drain-source on-state resistance	$R_{DS(on)}$	$V_{GS} = -10V, I_D = -6A$		195	250	m $\Omega$
		$V_{GS} = -4.5V, I_D = -6A$		220	280	
<b>Dynamic characteristics (note 3)</b>						
Input capacitance	$C_{iss}$	$V_{DS} = -25V, V_{GS} = 0V,$ $f = 1MHz$		760		pF
Output capacitance	$C_{oss}$			260		
Reverse transfer capacitance	$C_{rss}$			170		
<b>Switching characteristics (note 3)</b>						
Total gate charge	$Q_g$	$V_{DS} = -50V, V_{GS} = -10V,$ $I_D = -10A$		25		nC
Gate-source charge	$Q_{gs}$			5		
Gate-drain charge	$Q_{gd}$			7		
Turn-on delay time	$t_{d(on)}$	$V_{DD} = -50V, V_{GS} = -10V,$ $R_G = 9.1\Omega, I_D = -10A$		14		ns
Turn-on rise time	$t_r$			18		
Turn-off delay time	$t_{d(off)}$			50		
Turn-off fall time	$t_f$			18		
<b>Drain-Source Diode Characteristics</b>						
Drain-source diode forward voltage(note2)	$V_{SD}$	$V_{GS} = 0V, I_S = -10A$			-1.2	V
Continuous drain-source diode forward current	$I_S$				-12	A
Pulsed drain-source diode forward current	$I_{SM}$				-48	A

Notes:

1.  $L=0.5mH, V_{DD}=-50V, V_G=-10V, R_G=25\Omega, \text{Starting } T_J=25^\circ\text{C}.$
2. Pulse Test : Pulse Width $\leq 300\mu s$ , duty cycle  $\leq 2\%$ .
3. Guaranteed by design, not subject to production.

# Typical Characteristics

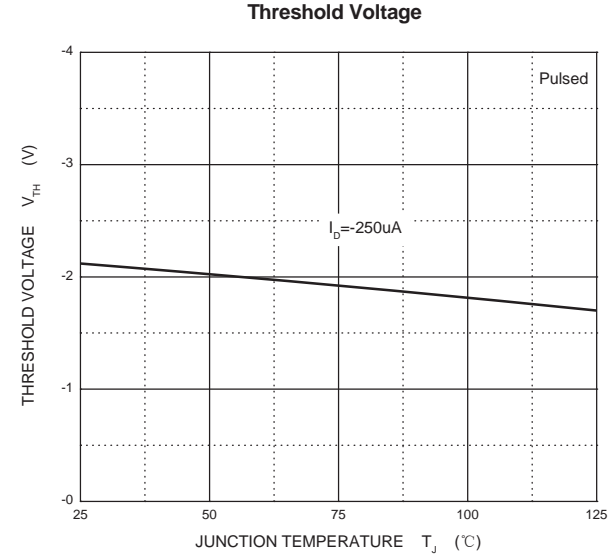
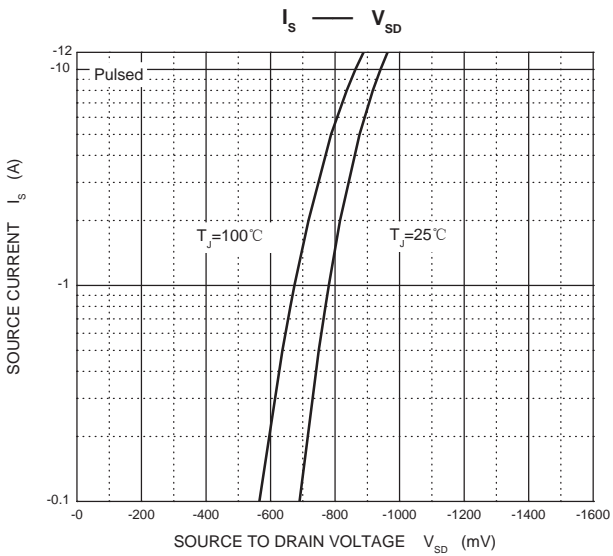
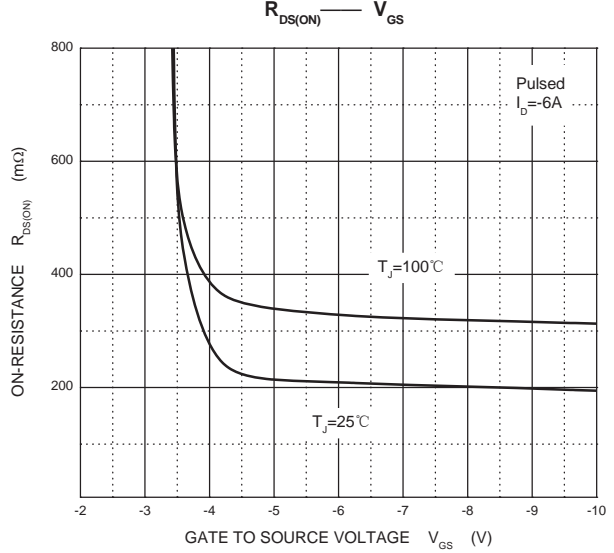
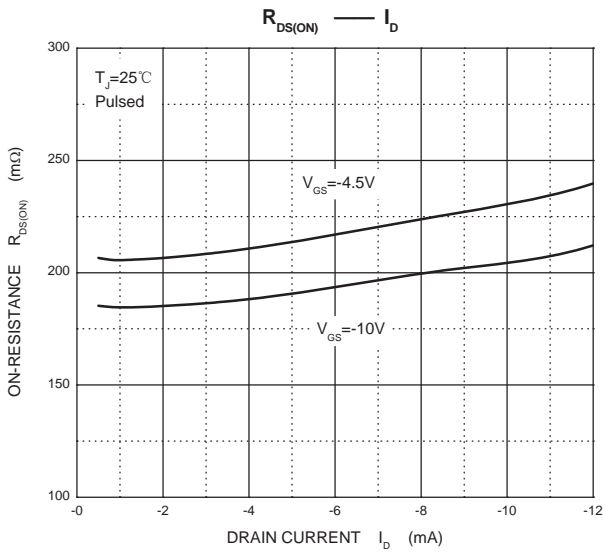
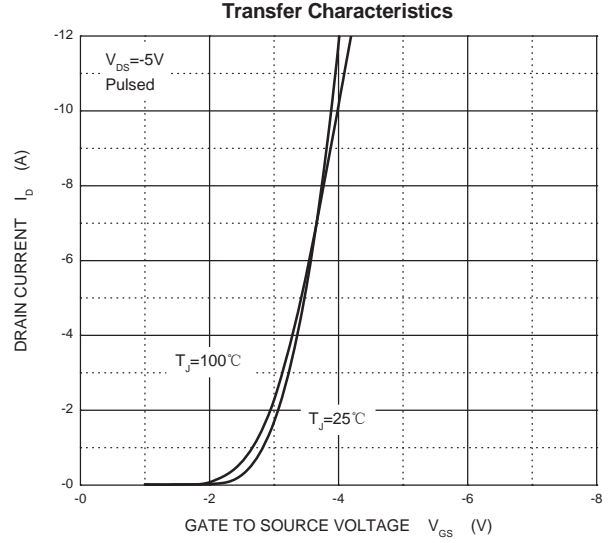
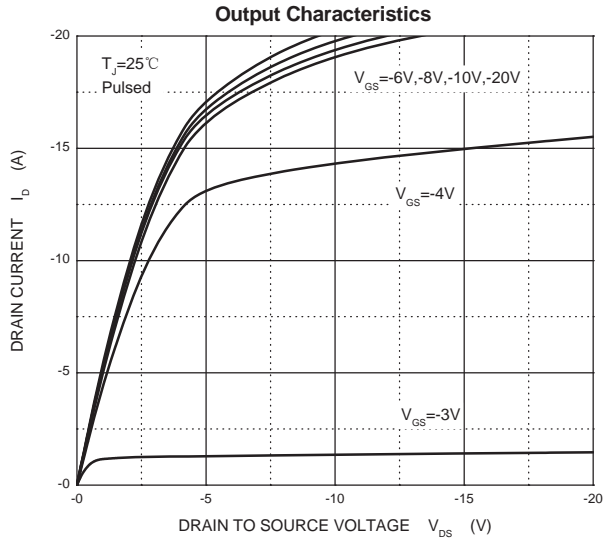

## TO-252-2L Package Outline Dimensions

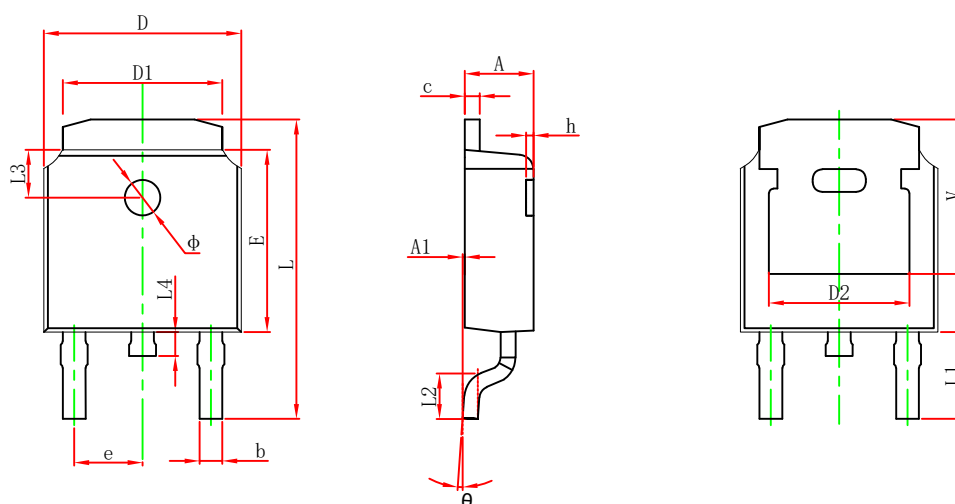

Symbol	Dimensions In Millimeters		Dimensions In Inches	
	Min.	Max.	Min.	Max.
A	2.200	2.400	0.087	0.094
A1	0.000	0.127	0.000	0.005
b	0.635	0.770	0.025	0.030
c	0.460	0.580	0.018	0.023
D	6.500	6.700	0.256	0.264
D1	5.100	5.460	0.201	0.215
D2	4.830 REF.		0.190 REF.	
E	6.000	6.200	0.236	0.244
e	2.186	2.386	0.086	0.094
L	9.712	10.312	0.382	0.406
L1	2.900 REF.		0.114 REF.	
L2	1.400	1.700	0.055	0.067
L3	1.600 REF.		0.063 REF.	
L4	0.600	1.000	0.024	0.039
$\Phi$	1.100	1.300	0.043	0.051
$\theta$	0°	8°	0°	8°
h	0.000	0.300	0.000	0.012
V	5.250 REF.		0.207 REF.	

## TO-252-2L Suggested Pad Layout

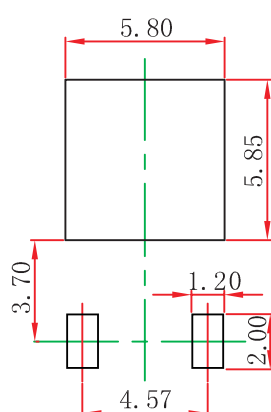

- Note:
1. Controlling dimension: in millimeters.
  2. General tolerance:  $\pm 0.05$  mm.
  3. The pad layout is for reference purposes only.

### NOTICE

JSCJ reserves the right to make modifications, enhancements, improvements, corrections or other changes without further notice to any product herein. JSCJ does not assume any liability arising out of the application or use of any product described herein.

# TO-252-2L Tape and Reel

## TO-252-2L Embossed Carrier Tape

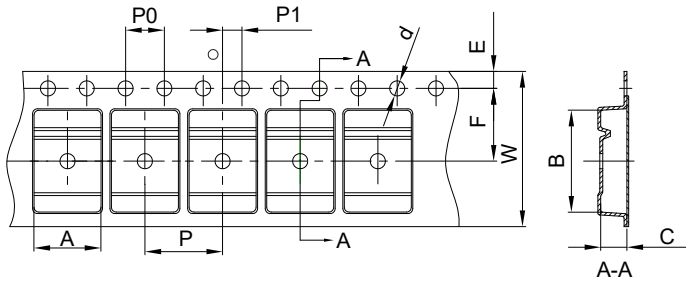

### Packaging Description:

TO-252-2L parts are shipped in tape. The carrier tape is made from a dissipative (carbon filled) polycarbonate resin. The cover tape is a multilayer film (Hear Activated Adhesive in nature) primarily composed of polyester film, adhesive layer, sealant, and anti-static sprayed agent. These reeled parts in standard option are shipped with 2500 units per 13" or 33.0 cm diameter reel. The reels are clear in color and is made of polystyrene plastic (anti-static coated).

Dimensions are in millimeter										
Pkg type	A	B	C	d	E	F	P0	P	P1	W
TO-252	6.90	10.50	2.70	Φ1.55	1.75	7.50	4.00	8.00	2.00	16.00

## TO-252-2L Tape Leader and Trailer

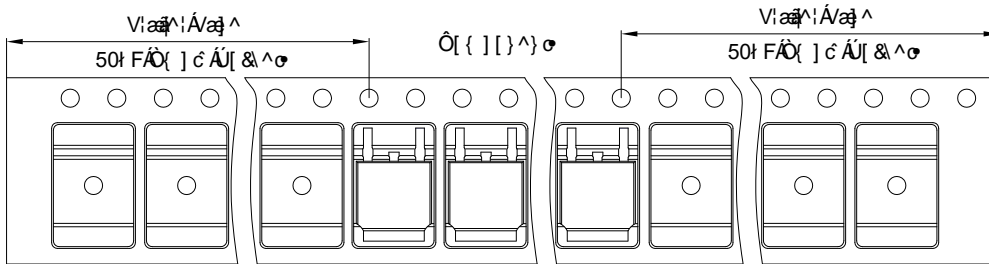

## TO-252-2L Reel

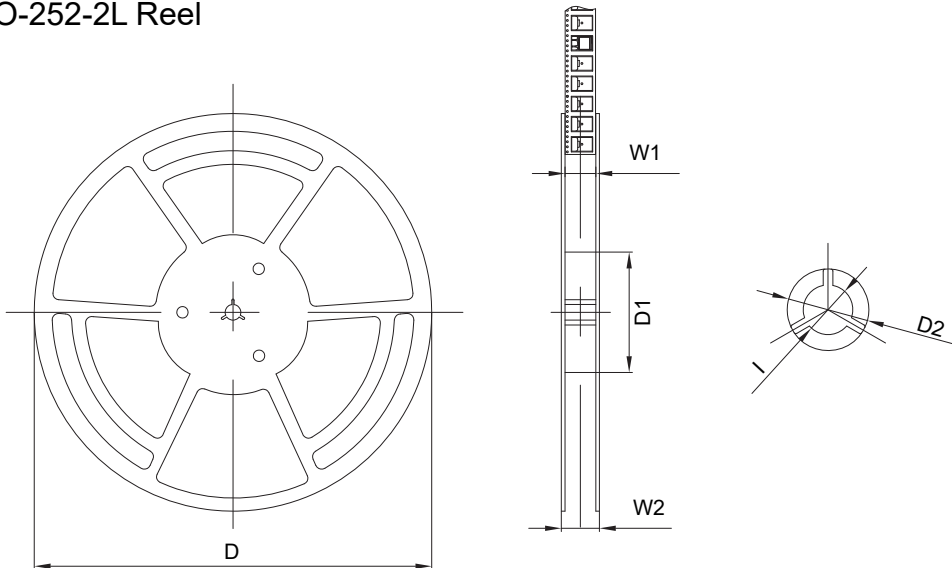

Dimensions are in millimeter						
Reel	D	D1	D2	W1	W2	l
13" Dia	330.00	100.00	Φ21.00	16.40	21.40	Φ13.00

Reel	Reel Size	Box	Box Size(mm)	Carton	Carton Size(mm)
2500 pcs	13 inch	5000 pcs	360×360×65	25000 pcs	378×358×382