



DFN1006-3L Plastic-Encapsulate Diodes

ESDBLD5V0B2 Bi-direction ESD Protection Diode

DESCRIPTION

Designed to protect voltage sensitive electronic components from ESD and other transients. Excellent clamping capability, low leakage, and fast response time provide best in class protection on designs that are exposed to ESD.

The combination of small size, high level of ESD protection makes them a flexible solution for applications such as HDMI, Display Port TM, and MDDI interfaces. It is designed to replace multi-layer varistors (MLV) in consumer equipments applications such as mobile phone, notebook, PAD, STB, LCD TV etc.

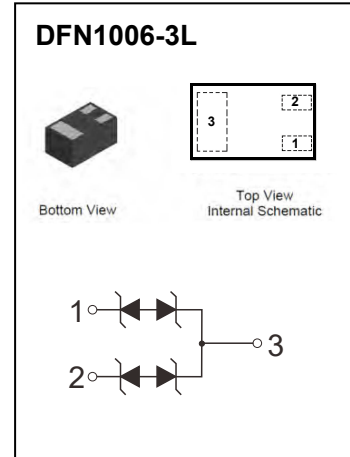

FEATURES

- Bi-directional ESD protection of two lines
- Reverse stand-off voltage: 5V
- Low reverse clamping voltage
- Low leakage current
- Excellent package: 1.0mm × 0.6mm × 0.47mm
- Fast response time
- JESD22-A114-B ESD Rating of class 3B per human body model
- IEC 61000-4-2 Level 4 ESD protection

APPLICATIONS

- Computers and peripherals
- Audio and video equipment
- Cellular handsets and accessories
- Portable electronics
- Other electronics equipments communication systems

MARKING

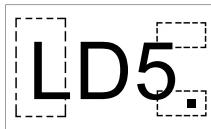

Front side

LD5= Device code
Solid dot=Pin1 indicator

MAXIMUM RATINGS (T_a=25°C unless otherwise noted)

Parameter	Symbol	Limit	Unit
IEC 61000-4-2 ESD Voltage	Air Model	±20	kV
	Contact Model	±20	
	Per Human Body Model	±30	
	Machine Model	±0.4	
JESD22-A114-B ESD Voltage	V _{ESD} ⁽¹⁾		
ESD Voltage	P _{PP} ⁽²⁾	55	W
Peak Pulse Power	I _{PP} ⁽²⁾	3.5	A
Peak Pulse Current	T _L	260	°C
Lead Solder Temperature – Maximum (10 Second Duration)	T _J , T _{stg}	-55 ~ +150	°C
Operation Junction and Storage Temperature Range			

(1).Device stressed with ten non-repetitive ESD pulses.

(2).Non-repetitive current pulse 8/20µs exponential decay waveform according to IEC61000-4-5.

ESD standards compliance

IEC61000-4-2 Standard

Contact Discharge		Air Discharge	
Level	Test Voltage kV	Level	Test Voltage kV
1	2	1	2
2	4	2	4
3	6	3	8
4	8	4	15

JESD22-A114-B Standard

ESD Class	Human Body Discharge V
0	0~249
1A	250~499
1B	500~999
1C	1000~1999
2	2000~3999
3A	4000~7999
3B	8000~15999

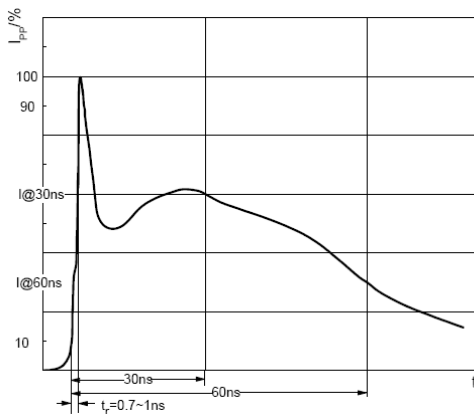

ESD pulse waveform according to IEC61000-4-2



8/20µs pulse waveform according to IEC 61000-4-5

ELECTRICAL PARAMETER

Symbol	Parameter
V_C	Clamping Voltage @ I_{PP}
I_{PP}	Peak Pulse Current
V_{BR}	Breakdown Voltage @ I_T
I_T	Test Current
I_R	Reverse Leakage Current @ V_{RWM}
V_{RWM}	Reverse Standoff Voltage

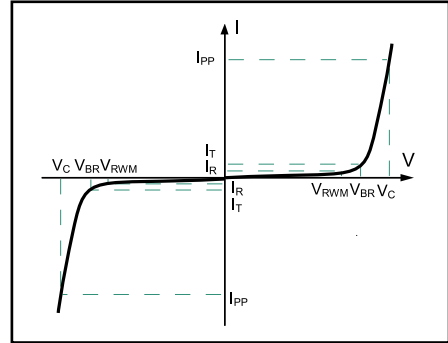

V-I characteristics for a Bi-direction ESD Protection Diode

ELECTRICAL CHARACTERISTICS ($T_a=25^\circ\text{C}$ unless otherwise specified)

Parameter	Symbol	Test conditions	Min	Typ	Max	Unit
Reverse stand off voltage	$V_{RWM}^{(1)}$				5	V
Reverse leakage current	I_R	$V_{RWM}=5V$			0.1	μA
Breakdown voltage	$V_{(BR)}$	$I_T=1\text{mA}$	6.0		9.0	V
Clamping voltage	V_C	$I_{PP}=3.5\text{A}$		14.4	17	V
TLP clamping voltage	V_C	$I_{TLP}=8\text{A}$, Pulse Width=100ns		12.7		V
		$I_{TLP}=16\text{A}$, Pulse Width=100ns		14.6		V
Dynamic resistance	$R_{DYN}^{(3)}$	Pulse Width=100ns		0.24		Ω
Junction capacitance	C_J	$V_R=0V, f=1\text{MHz}$		3	4	pF

(1).Other voltages available upon request.

(2).Non-repetitive current pulse 8/20 μs exponential decay waveform according to IEC61000-4-5.

(3). R_{DYN} is calculated from 8A to 16A.

TYPICAL CHARACTERISTICS

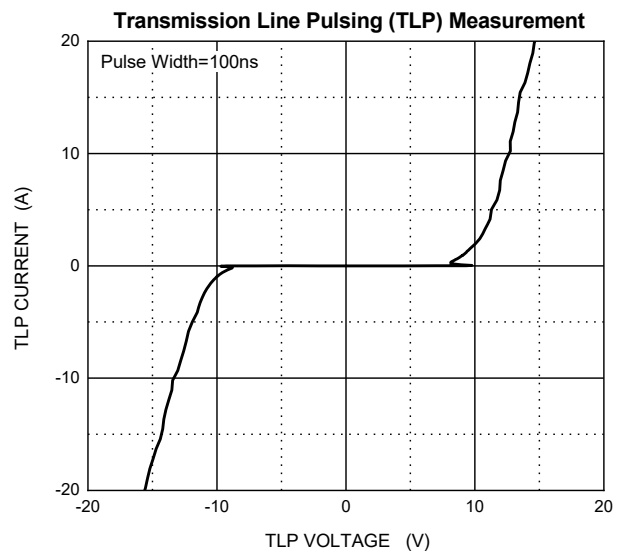
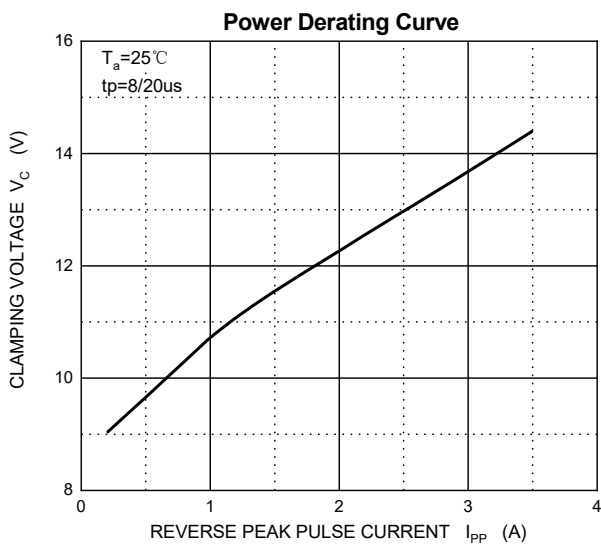
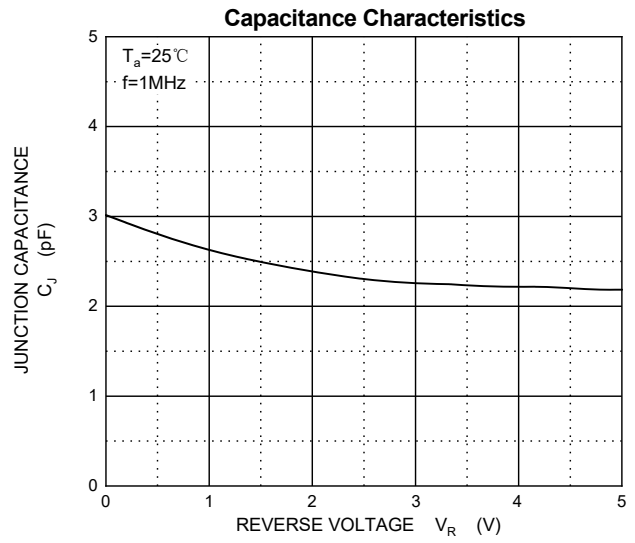
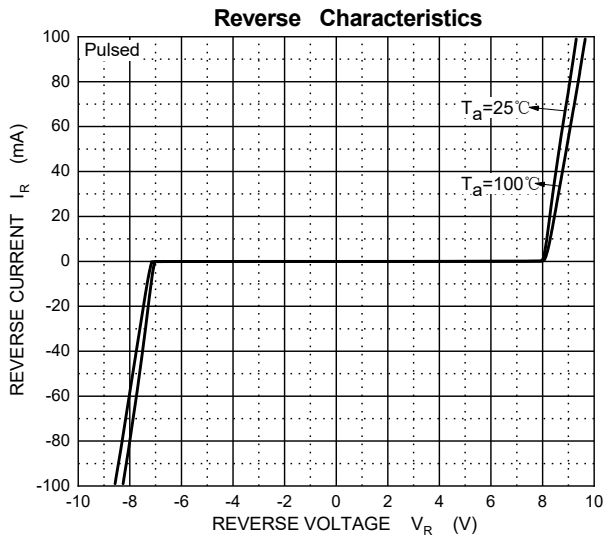

PACKAGE OUTLINE AND PAD LAYOUT INFORMATION

DFN1006-3L Package Outline Dimensions

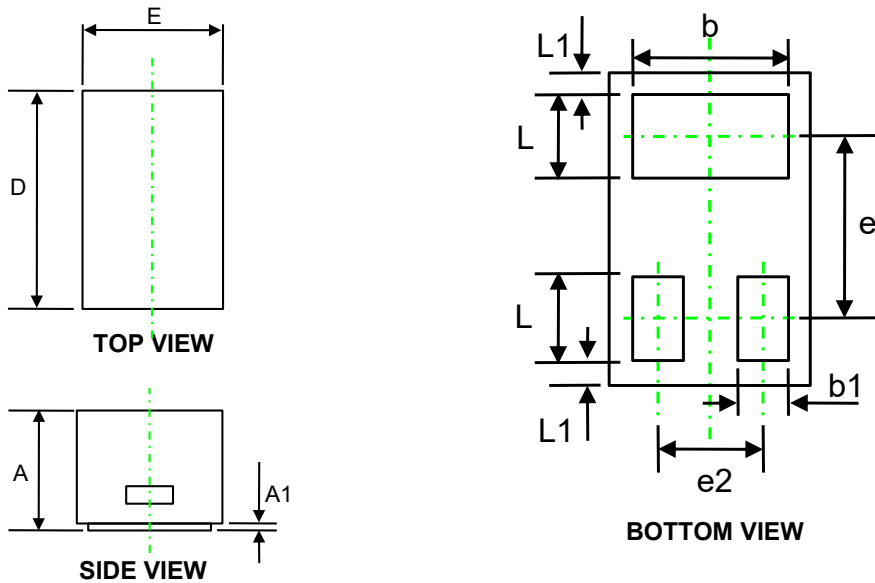

Symbol	Dimensions In Millimeters		Dimensions In Inches	
	Min.	Max.	Min.	Max.
A	0.400	0.550	0.016	0.022
A1	0.000	0.050	0.000	0.002
D	0.950	1.050	0.037	0.041
E	0.550	0.650	0.022	0.026
b	0.450	0.550	0.018	0.022
e	0.650 REF.		0.026 REF.	
e2	0.350 REF.		0.014 REF.	
L1	0.050 REF.		0.002 REF.	
L	0.200	0.300	0.008	0.012
b1	0.100	0.200	0.004	0.008

DFN1006-3L Suggested Pad Layout

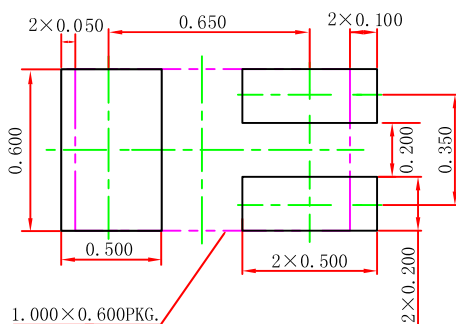

Note:

1. Controlling dimension: in millimeters.
2. General tolerance: ± 0.050 mm.
3. The pad layout is for reference purposes only.

NOTICE

JSCJ reserves the right to make modifications, enhancements, improvements, corrections or other changes without further notice to any product herein. JSCJ does not assume any liability arising out of the application or use of any product described herein.

TAPE AND REEL INFORMATION

DFN1006-3L Embossed Carrier Tape

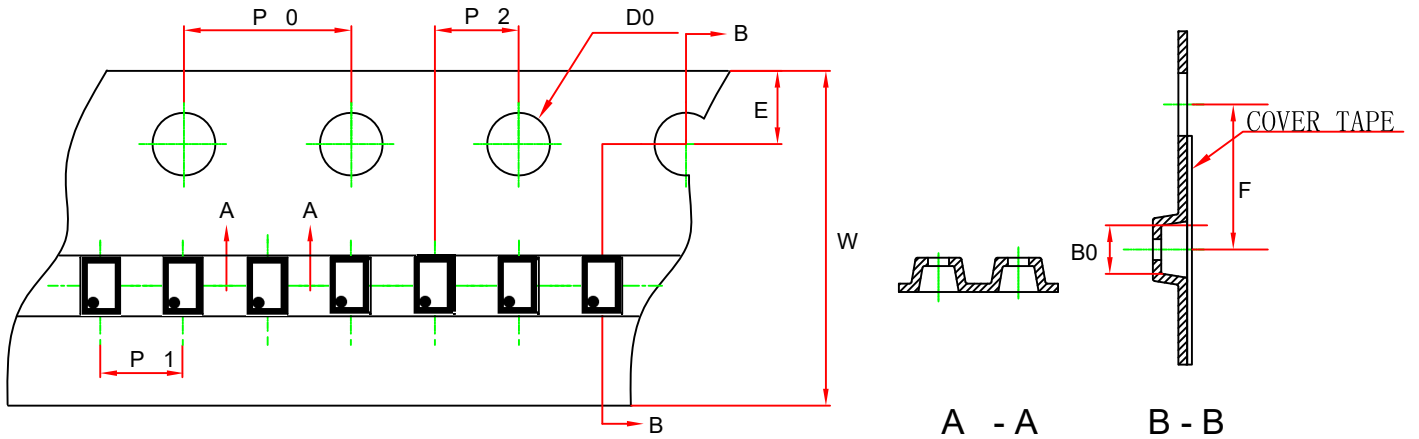

Dimensions In Millimeters (mm)								
Pkg type	B0	P0	P1	P2	E	F	W	D0
DFN1006-3L	1.11	4.00	2.00	2.00	1.75	3.50	8.00	1.55
Tolerance	+/-0.06	+/-0.1	+/-0.1	+/-0.1	+/-0.1	+/-0.1	+/-0.3	+/-0.1

DFN1006-3L Tape Leader and Trailer

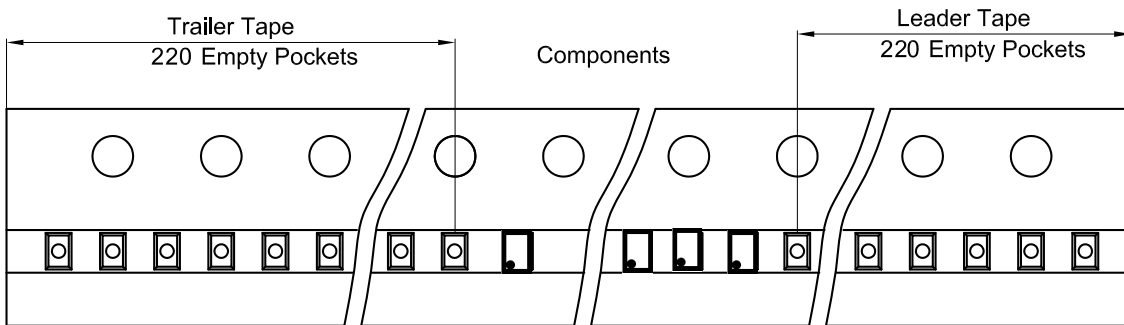

DFN1006-3L Reel

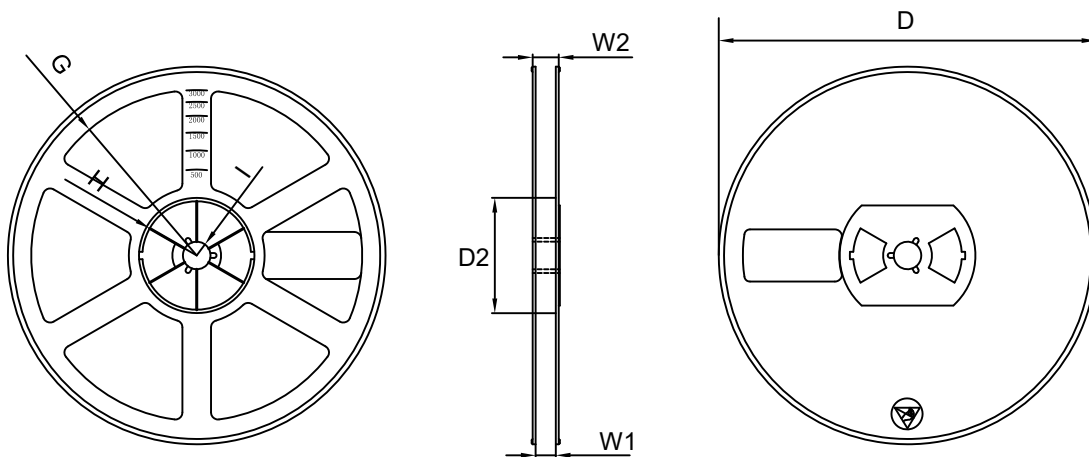

Symbol	Dimensions In Millimeters (mm)						
	D	D2	G	H	I	W1	W2
7" Dia	Φ178.00	54.50	R78.00	R25.6	R6.5	9.50	12.30
Tolerance	+/-2	+/-1	+/-1	+/-1	+/-1	+/-2	+/-1.5

REEL	Reel Size	Box	Box size(mm)	Carton	Carton Size(mm)
10000 pcs	7 inch	150000 pcs	220×220×210	600000 pcs	450×450×240