



TO-92 Plastic-Encapsulate Transistors

KTC3192 TRANSISTOR(NPN)

FEATURE

- High Power Gain: $G_{pe}=29\text{dB(Typ)}(f=10.7\text{MHz})$

TO-92

1. EMITTER
2. COLLECTOR
3. BASE

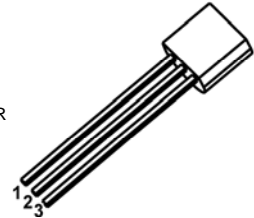

MARKING

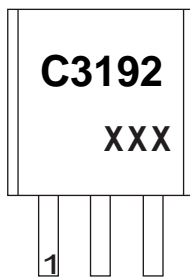

C3192=Device code
 XXX=Code
 GXX=Green molding compound device
 CXX=Normal molding compound device

Equivalent Circuit

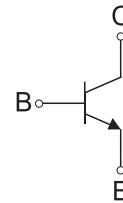

ORDERING INFORMATION

Part Number	Package	Packing Method	Pack Quantity
KTC3192	TO-92	Bulk	1000pcs/Bag
KTC3192-TA	TO-92	Tape	2000pcs/Box

MAXIMUM RATINGS ($T_a=25\text{ }^\circ\text{C}$ unless otherwise noted)

Symbol	Parameter	Value	Unit
V_{CBO}	Collector-Base Voltage	35	V
V_{CEO}	Collector-Emitter Voltage	30	V
V_{EBO}	Emitter-Base Voltage	4	V
I_C	Collector Current -Continuous	50	mA
P_C	Collector Power Dissipation	625	mW
T_J, T_{stg}	Operation Junction and Storage Temperature Range	-55-150	$^\circ\text{C}$

ELECTRICAL CHARACTERISTICS

$T_a=25^\circ\text{C}$ unless otherwise specified

Parameter	Symbol	Test conditions	MIN	TYP	MAX	UNIT
Collector-base breakdown voltage	$V_{(BR)CBO}$	$I_C=100\mu\text{A}, I_E=0$	35			V
Collector-emitter breakdown voltage	$V_{(BR)CEO}$	$I_C=1\text{mA}, I_B=0$	30			V
Emitter-base breakdown voltage	$V_{(BR)EBO}$	$I_E=100\mu\text{A}, I_C=0$	4			V
Collector cut-off current	I_{CBO}	$V_{CB}=35\text{V}, I_E=0$			0.1	μA
Emitter cut-off current	I_{EBO}	$V_{EB}=4\text{V}, I_C=0$			1.0	μA
DC current gain	h_{FE}	$V_{CE}=12\text{V}, I_C=2\text{mA}$	40		240	
Collector-emitter saturation voltage	$V_{CE(sat)}$	$I_C=10\text{mA}, I_B=1\text{mA}$			0.4	V
Base-emitter saturation voltage	$V_{BE(sat)}$	$I_C=10\text{mA}, I_B=1\text{mA}$			1.0	V
Transition frequency	f_T	$V_{CE}=10\text{V}, I_C=1\text{mA}$	100		400	MHz
Collector output capacitance	C_{ob}	$V_{CB}=10\text{V}, I_E=0, f=1\text{MHz}$	1.4		3.2	pF
Collector-base time constant	$C_{c.rbb'}$	$V_{CE}=10\text{V}, I_C=1\text{mA}, f=30\text{MHz}$	10		50	pS
Power gain	G_{pe}	$V_{CC}=6\text{V}, I_C=1\text{mA}, f=10.7\text{MHz}$	27		33	dB

CLASSIFICATION OF h_{FE}

Rank	R	O	Y
Range	40-80	70-140	120-240

TO-92 Package Outline Dimensions

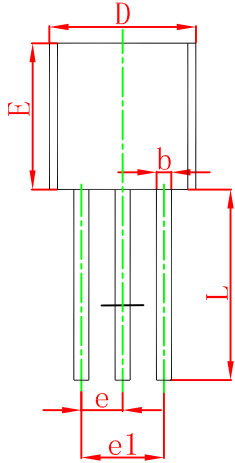
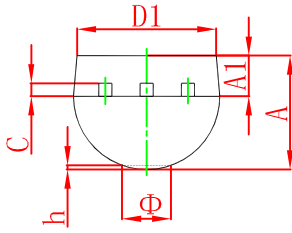

Symbol	Dimensions In Millimeters		Dimensions In Inches	
	Min	Max	Min	Max
A	3.300	3.700	0.130	0.146
A1	1.100	1.400	0.043	0.055
b	0.380	0.550	0.015	0.022
c	0.360	0.510	0.014	0.020
D	4.300	4.700	0.169	0.185
D1	3.430		0.135	
E	4.300	4.700	0.169	0.185
e	1.270 TYP		0.050 TYP	
e1	2.440	2.640	0.096	0.104
L	14.100	14.500	0.555	0.571
Φ		1.600		0.063
h	0.000	0.380	0.000	0.015

TO-92 Suggested Pad Layout

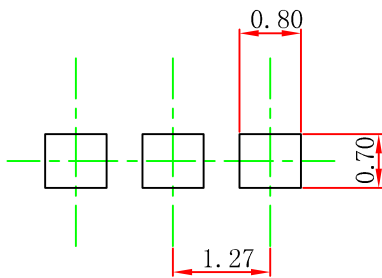

Note:

1. Controlling dimension: in millimeters.
2. General tolerance: ± 0.05 mm.
3. The pad layout is for reference purposes only.

NOTICE

JSCJ reserves the right to make modifications, enhancements, improvements, corrections or other changes without further notice to any product herein. JSCJ does not assume any liability arising out of the application or use of any product described herein.

TO-92 PACKAGE TAPING DIMENSION

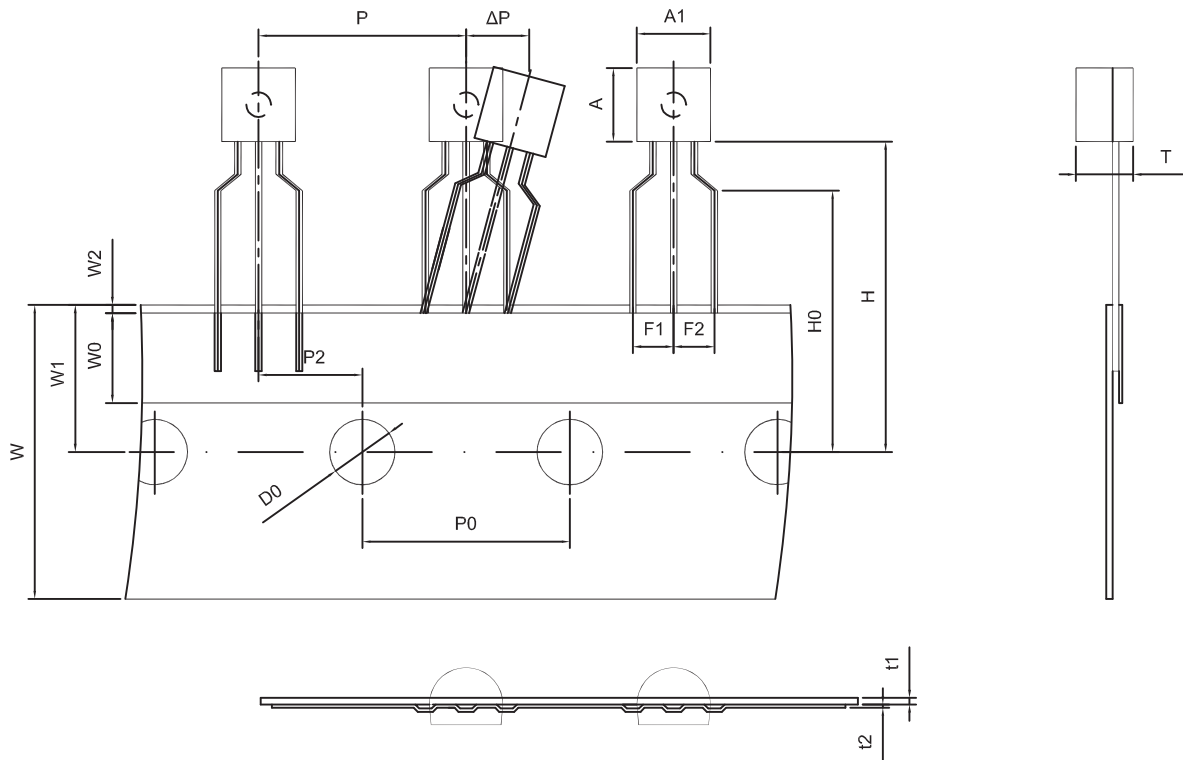

Dimensions are in millimeter

A1	A	T	P	P0	P2	F1	F2	W
4.5	4.5	3.5	12.7	12.7	6.35	2.5	2.5	18.0
W0	W1	W2	H	H0	D0	t1	t2	ΔP
6.0	9.0	1.0 MAX.	19.0	16.0	4.0	0.4	0.2	0

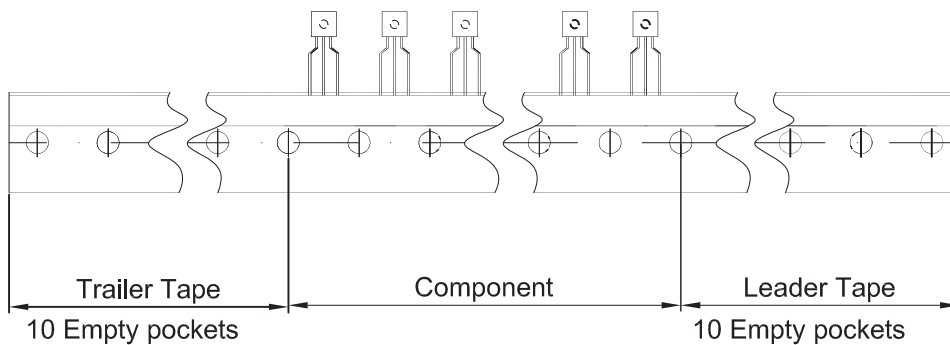

Package	Box	Box Size(mm)	Carton	Carton Size(mm)
TO-92	2000 pcs	333×162×43	20,000 pcs	350×340×250