

SOD-323 Plastic-Encapsulate Diodes

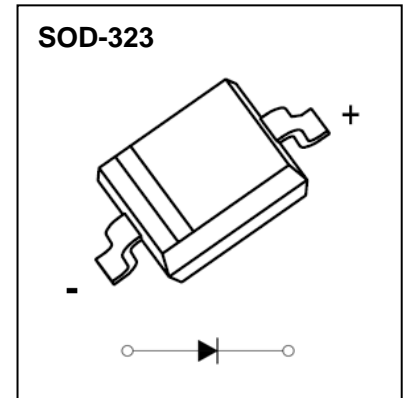

MBRX0520-MBRX0560 SCHOTTKY BARRIER DIODE

FEATURES

- Low Forward Voltage
- Lead Free Finish/RoHS Compliant
- For Surface Mount Application and High Current Capability

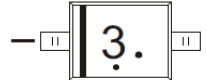

MARKING

MBRX0520:2.	MBRX0530:3.	MBRX0540:4.	MBRX0560:6.
			

The marking bar indicates the cathode
 Solid dot = Green molding compound device.

MAXIMUM RATINGS ($T_a=25^{\circ}\text{C}$ unless otherwise noted)

Symbol	Parameter	MBRX 0520	MBRX 0530	MBRX 0540	MBRX 0560	Unit
V_{RRM}	Peak Repetitive Reverse Voltage	20	30	40	60	V
$V_{R(RMS)}$	RMS Reverse Voltage	14	21	28	42	V
I_o	Average Rectified Output Current	0.5				A
I_{FSM}	Non-repetitive Peak Forward Surge Current@t=8.3ms	5				A
P_D	Power Dissipation	250				mW
$R_{\theta JA}$	Thermal Resistance from Junction to Ambient	400				$^{\circ}\text{C}/\text{W}$
T_j	Operating Junction Temperature Range	-40 ~ +125				$^{\circ}\text{C}$
T_{stg}	Storage Temperature Range	-55 ~ +150				$^{\circ}\text{C}$

ELECTRICAL CHARACTERISTICS

$T_a=25\text{ }^\circ\text{C}$ unless otherwise specified

Parameter	Symbol	Test conditions	Min	Typ	Max	Unit
Reverse voltage						
MBRX0520	$V_{(BR)}$	$I_R=1\text{mA}$	20			V
MBRX0530			30			
MBRX0540			40			
MBRX0560			60			
Reverse current						
MBRX0520	I_R	$V_R=20\text{V}$			0.08	mA
MBRX0530		$V_R=30\text{V}$				
MBRX0540		$V_R=40\text{V}$				
MBRX0560		$V_R=60\text{V}$				
Forward voltage						
MBRX0520	V_F	$I_F=0.5\text{A}$			0.45	V
MBRX0530					0.55	
MBRX0540					0.55	
MBRX0560					0.70	
Total capacitance	C_T	$V_R=4\text{V}, f=1\text{MHz}$		30		pF

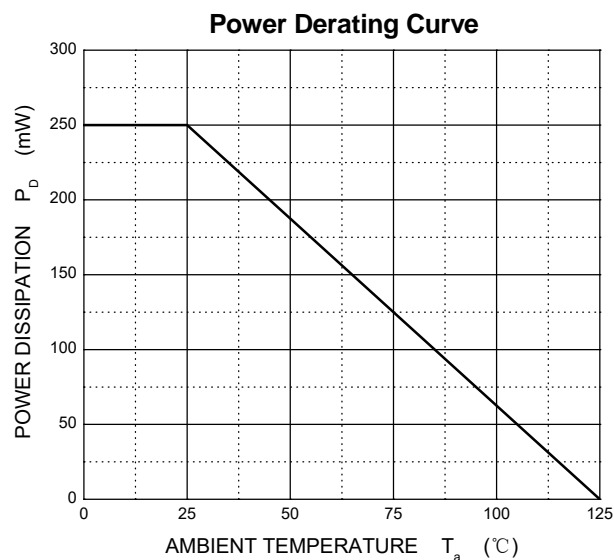
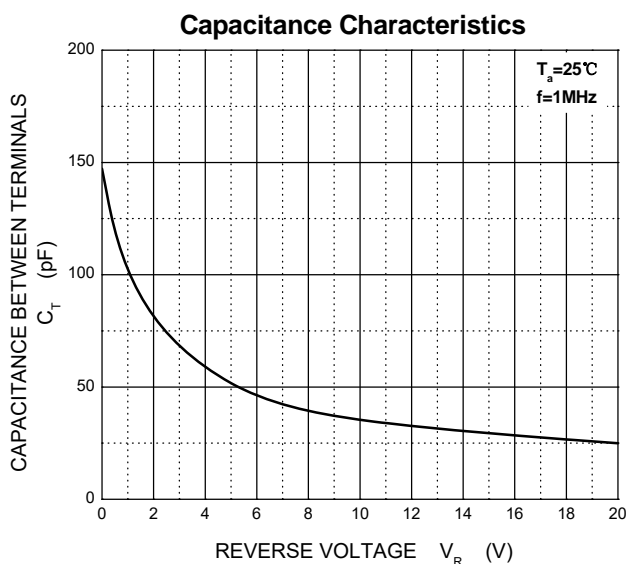
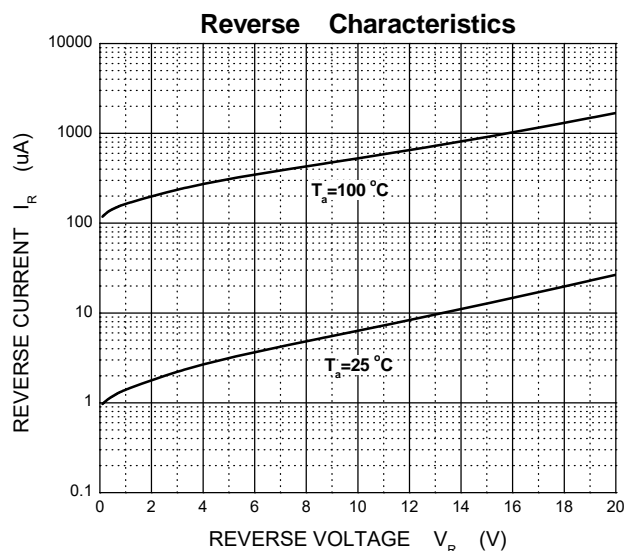
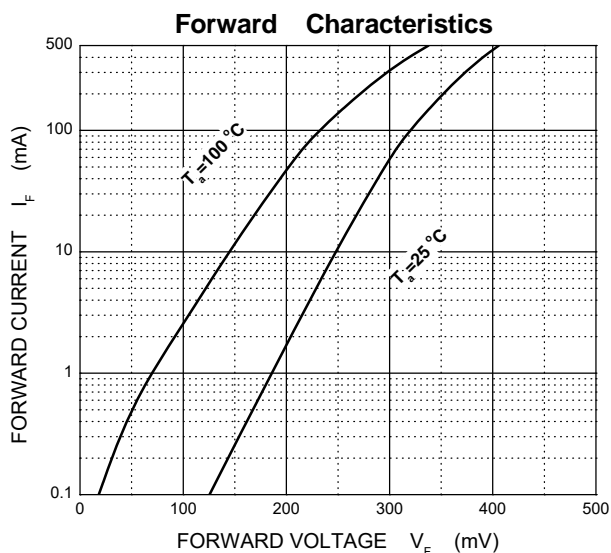

SOD-323 Package Outline Dimensions

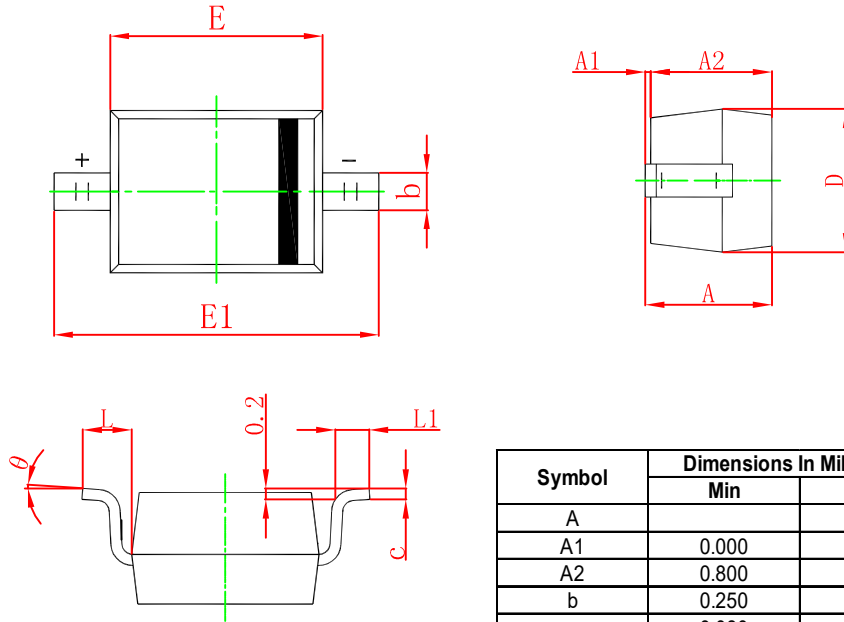

Symbol	Dimensions In Millimeters		Dimensions In Inches	
	Min	Max	Min	Max
A		1.100		0.043
A1	0.000	0.100	0.000	0.004
A2	0.800	1.000	0.031	0.039
b	0.250	0.350	0.010	0.014
c	0.080	0.150	0.003	0.006
D	1.200	1.400	0.047	0.055
E	1.600	1.800	0.063	0.071
E1	2.500	2.750	0.098	0.108
L	0.475 REF		0.019 REF	
L1	0.250	0.400	0.010	0.016
θ	0°		8°	

SOD-323 Suggested Pad Layout

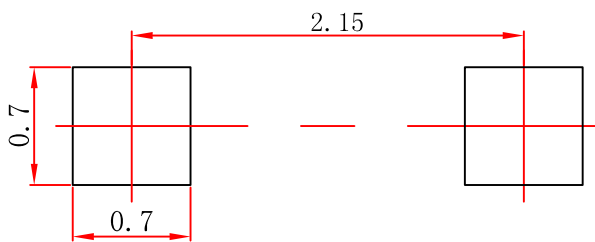

- Note:**
1. Controlling dimension: in millimeters.
 2. General tolerance: ± 0.05mm.
 3. The pad layout is for reference purposes only.

NOTICE

JSCJ reserves the right to make modifications, enhancements, improvements, corrections or other changes without further notice to any product herein. JSCJ does not assume any liability arising out of the application or use of any product described herein.

SOD-323 Tape and Reel

SOD-323 Embossed Carrier Tape

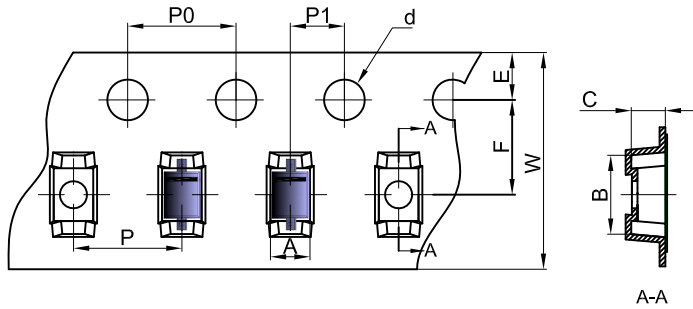

Packaging Description:

SOD-323 parts are shipped in tape. The carrier tape is made from a dissipative (carbon filled) polycarbonate resin. The cover tape is a multilayer film (Heat Activated Adhesive in nature) primarily composed of polyester film, adhesive layer, sealant, and anti-static sprayed agent. These reeled parts in standard option are shipped with 3,000 units per 7" or 17.8cm diameter reel. The reels are clear in color and is made of polystyrene plastic (anti-static coated).

Dimensions are in millimeter										
Pkg type	A	B	C	d	E	F	P0	P	P1	W
SOD-323	1.48	3.3	1.25	Ø1.50	1.75	3.50	4.00	4.00	2.00	8.00

SOD-323 Tape Leader and Trailer

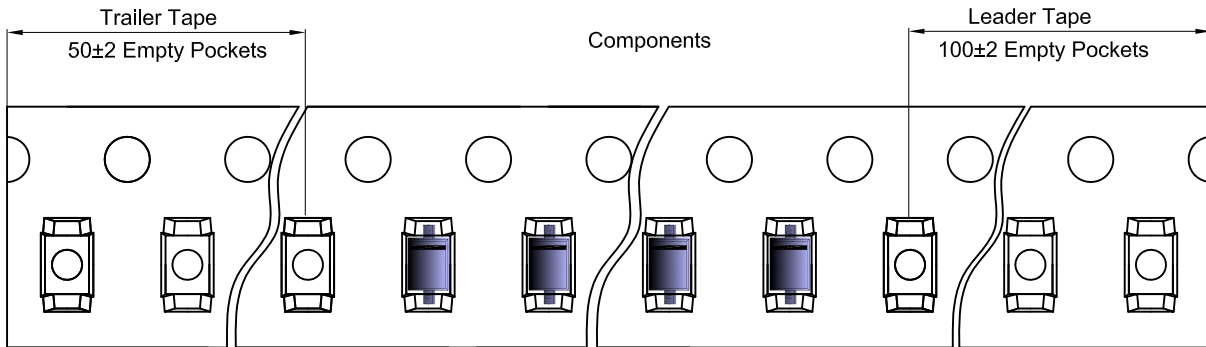

SOD-323 Reel

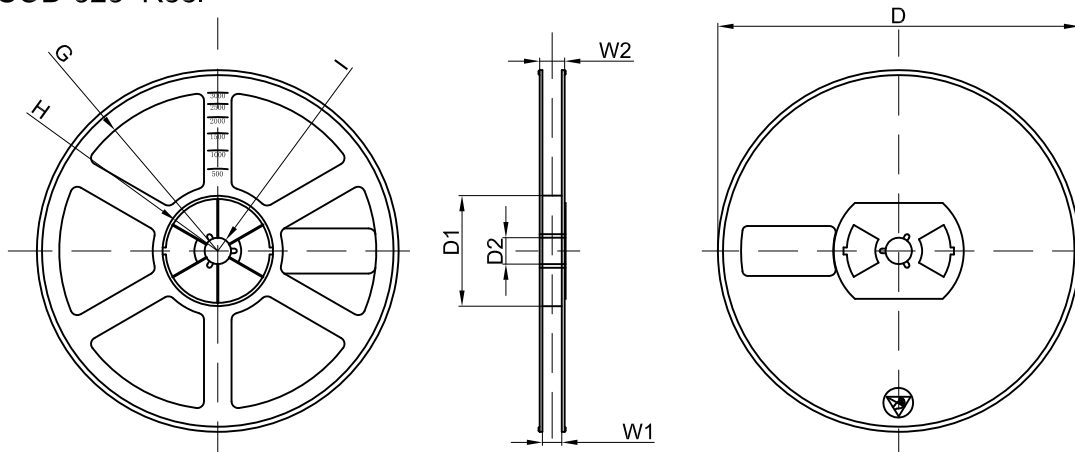

Dimensions are in millimeter								
Reel Option	D	D1	D2	G	H	I	W1	W2
7"Dia	Ø178.00	54.40	13.00	R78.00	R25.60	R6.50	9.50	12.30

REEL	Reel Size	Box	Box Size(mm)	Carton	Carton Size(mm)	G.W.(kg)
3000 pcs	7 inch	45,000 pcs	203×203×195	180,000 pcs	438×438×220	