

TO-220-2L Plastic-Encapsulate Diode

MUR10H60 HYPERFAST RECTIFIER, FRED

MAIN CHARACTERISTICS

I_o	10A
V_{RRM}	600V
T_{rr}	24ns
T_j	175°C
$V_{F(typ)}$	1.06V(@ $T_j=150^\circ\text{C}$)

FEATURES

- Ultrafast Recovery Times and Low Recovery Loss
- Low Forward Voltage
- Low Reverse Leakage Current

APPLICATIONS

Specifically designed to improve efficiency of PFC and output rectification stages of EV / HEV battery charging stations, booster stage of solar inverters and UPS applications, these devices are perfectly matched to operate with MOSFETs or high speed IGBTs.

MARKING

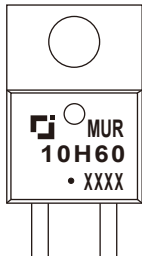

MUR10H60 = Device code
 Solid dot = Green molding compound device
 if none, the normal device
 XXXX = Code

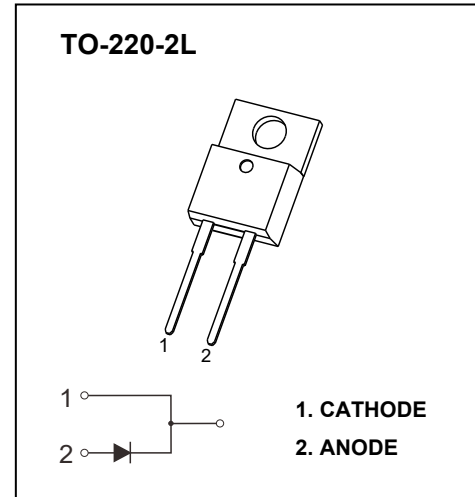

MAXIMUM RATINGS ($T_c=25^\circ\text{C}$ unless otherwise noted)

Symbol	Parameter	MUR10H60	Unit
V_{RRM}	Peak Repetitive Reverse Voltage	600	V
V_R	DC Blocking Voltage		
$I_{F(AV)}$	Average Forward Current($T_c=146^\circ\text{C}$)	10	A
$I_{F(RMS)}$	RMS Forward Current($T_c=146^\circ\text{C}$)	14	A
I_{FSM}	Non-Repetitive Surge Forward Current (8.3ms)	160	A
P_D	Power dissipation	62.5	W
$R_{\theta JC}$	Thermal Resistance From Junction to Case	2.4	$^\circ\text{C/W}$
T_j	Operating Junction Temperature Range	-55 ~ +175	$^\circ\text{C}$
T_{stg}	Storage Temperature Range	-55 ~ +175	$^\circ\text{C}$

Typical Characteristics

ELECTRICAL CHARACTERISTICS ($T_c=25^\circ\text{C}$ unless otherwise specified)

Symbol	Parameter	Test Conditions	Min.	Typ.	Max.	Unit
$V_{(BR)}$	Reverse Voltage	$I_R=100\mu\text{A}$	600			V
I_R	Reverse Current	$V_R=600\text{V}$	$T_J=25^\circ\text{C}$		10	μA
			$T_J=150^\circ\text{C}$		500	μA
V_F	Forward Voltage	$I_F=10\text{A}$	$T_J=25^\circ\text{C}$	1.3	1.6	V
			$T_J=150^\circ\text{C}$	1.06		V
C_{tot}	Total Capacitance	$V_R=200\text{V}, f=1\text{MHz}$		12		pF
t_{rr}	Reverse Recovery time	$I_F=0.5\text{A}, I_R=1\text{A}, I_{rr}=0.25\text{A}$		32		ns
		$I_F=1\text{A}, V_R=30\text{V}, di_F/dt = 200\text{A/us}$		24		ns

ELECTRICAL CHARACTERISTICS ($T_c=25^\circ\text{C}$ unless otherwise specified)

Symbol	Parameter	Test Conditions	Min.	Typ.	Max.	Unit
t_{rr}	Reverse Recovery Time	$I_F=10\text{A}, V_R=400\text{V}, di_F/dt=200\text{A}/\mu\text{s}$		76		ns
I_{RRM}	Max. Reverse Recovery Current			4.8		A
Q_{rr}	Reverse Recovery Charge			223		nC
t_{rr}	Reverse Recovery Time	$I_F=10\text{A}, V_R=400\text{V}, di_F/dt=200\text{A}/\mu\text{s}, T_J=125^\circ\text{C}$		105		ns
I_{RRM}	Max. Reverse Recovery Current			8		A
Q_{rr}	Reverse Recovery Charge			495		nC
t_{rr}	Reverse Recovery Time	$I_F=10\text{A}, V_R=400\text{V}, di_F/dt=600\text{A}/\mu\text{s}, T_J=125^\circ\text{C}$		60		ns
I_{RRM}	Max. Reverse Recovery Current			19		A
Q_{rr}	Reverse Recovery Charge			646		nC

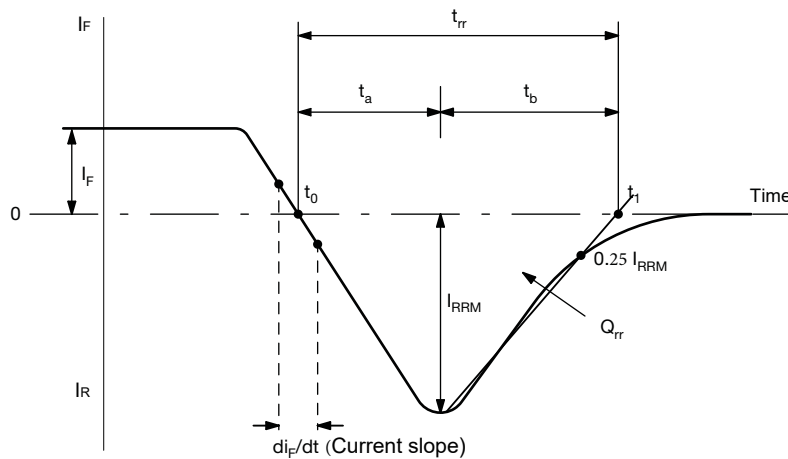

Reverse Recovery Waveform and Definitions

Typical Characteristics

Forward Characteristics

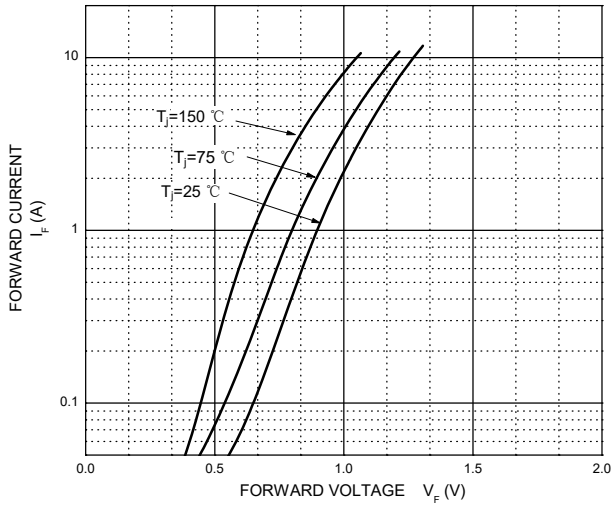

Reverse Characteristics

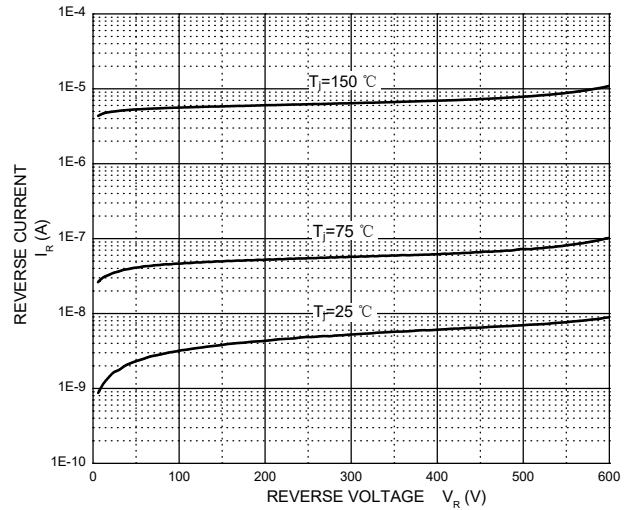

Capacitance Characteristics

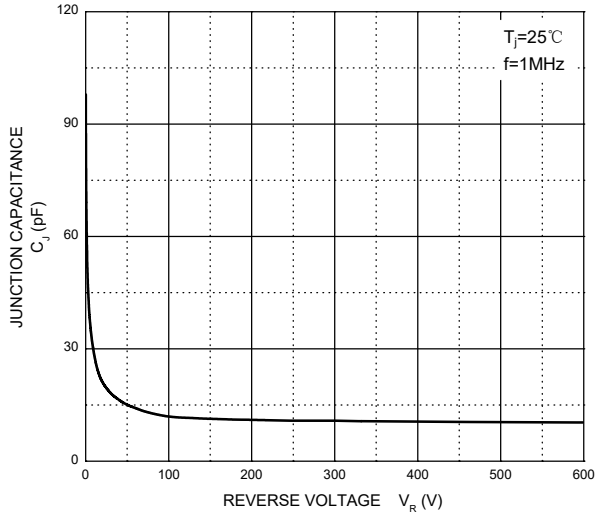

Recovery Current vs. di_F/dt

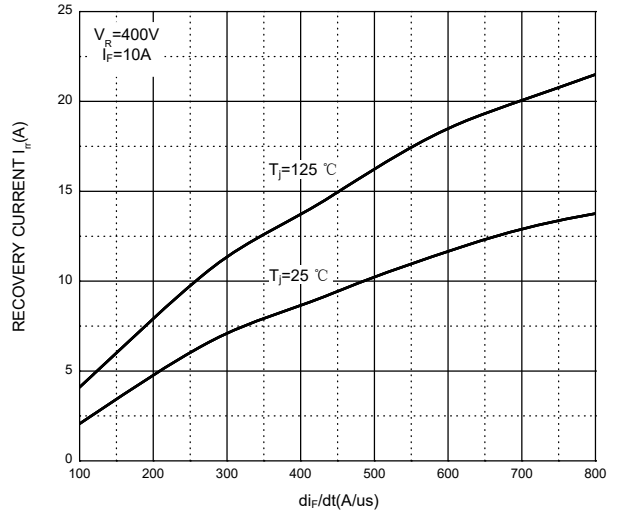

Reverse Recovery Time vs. di_F/dt

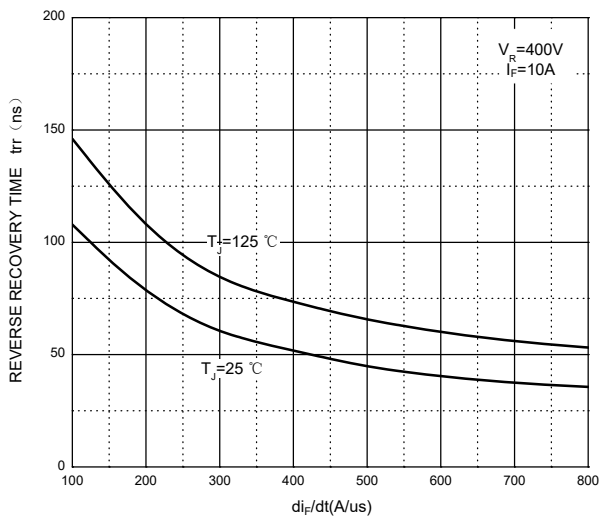

Stored Charge vs. di_F/dt

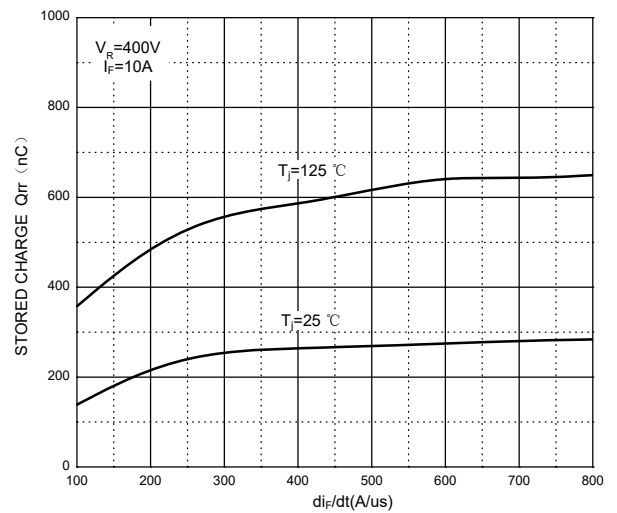

Typical Characteristics

Dynamic Parameters vs. Junction Temperature

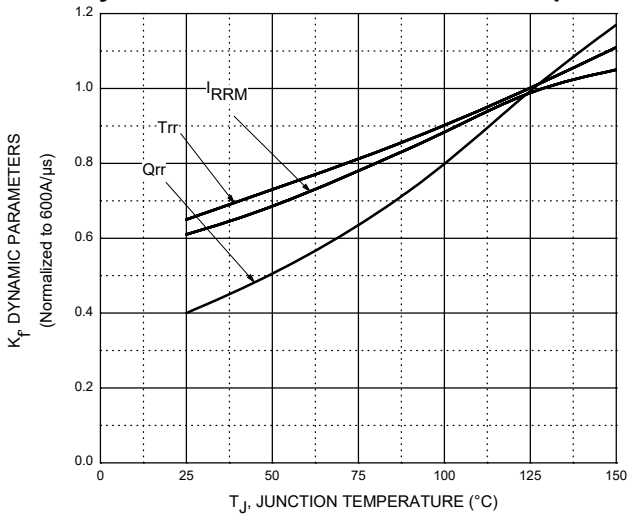

Current Derating

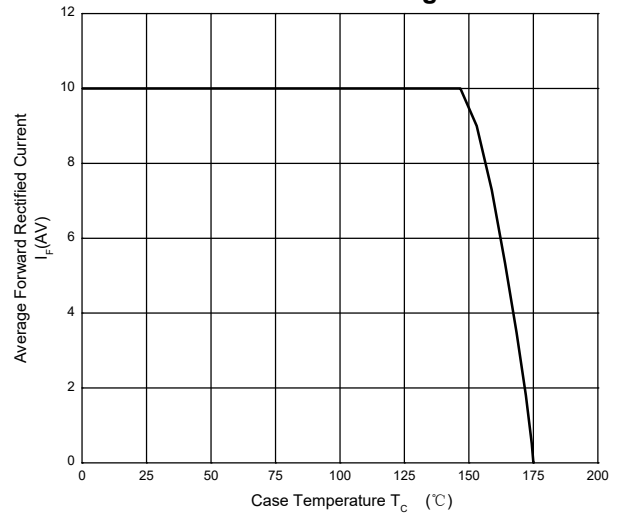

MUR10H60 Transient Thermal Impedance, Junction-Case

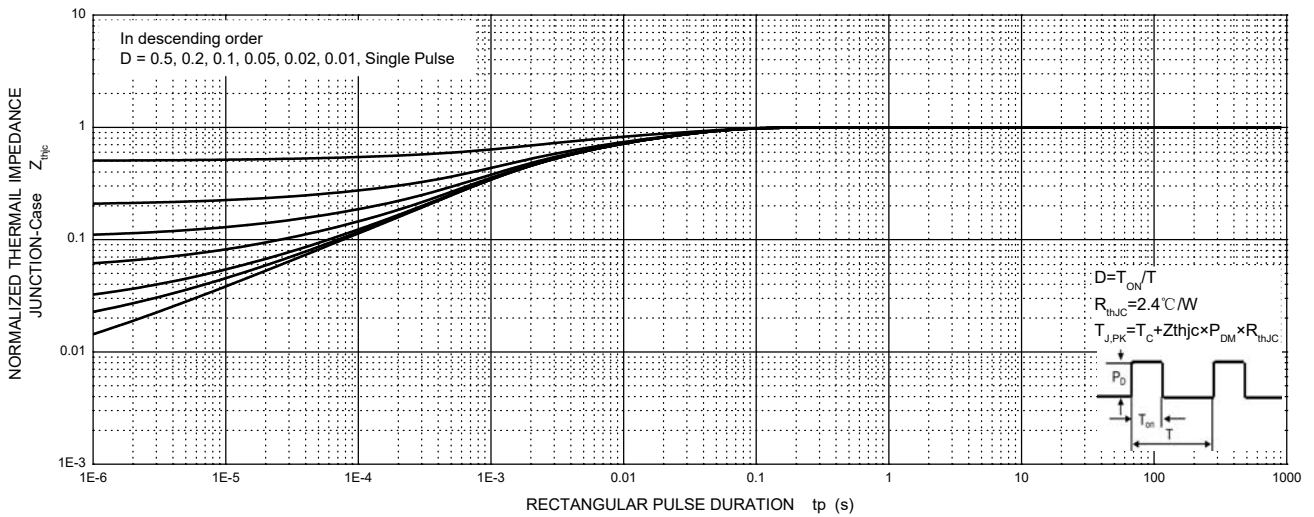

TO-220-2L Package Outline Dimensions

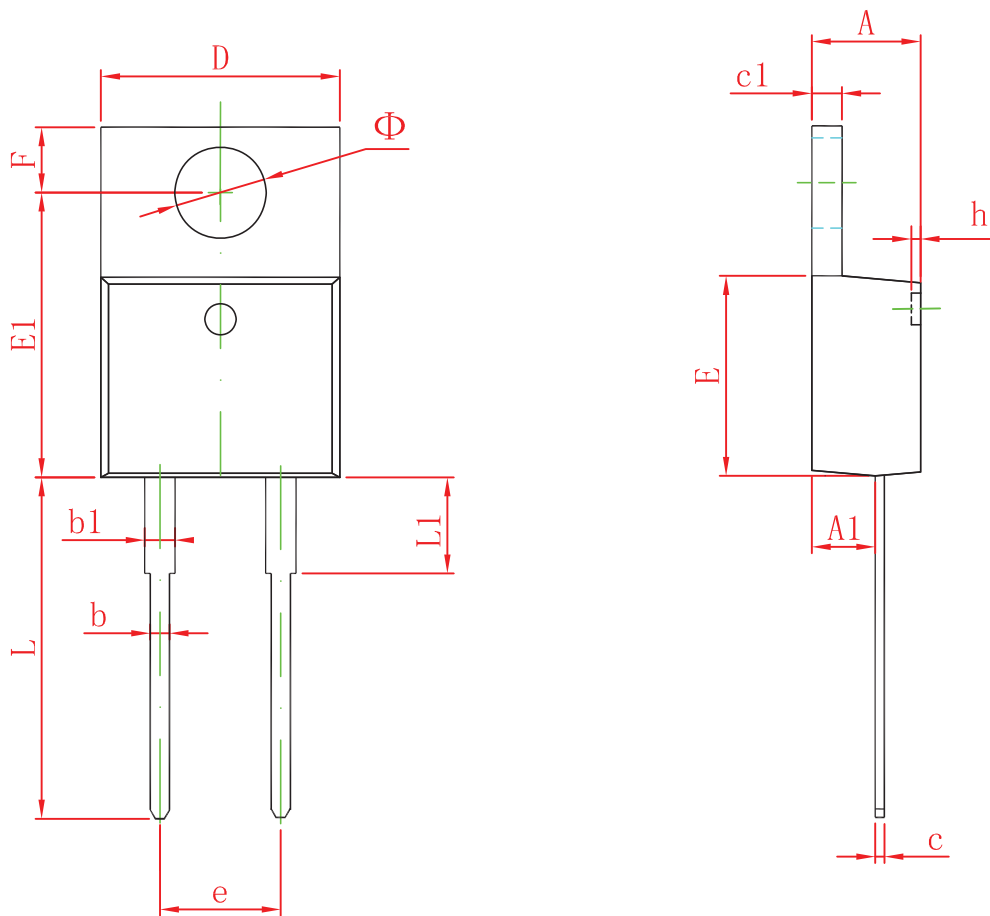

Symbol	Dimensions In Millimeters		Dimensions In Inches	
	Min	Max	Min	Max
A	4.450	4.750	0.175	0.187
A1	2.520	2.820	0.099	0.111
b	0.710	0.910	0.028	0.036
b1	1.170	1.370	0.046	0.054
c	0.300	0.500	0.012	0.020
c1	1.170	1.370	0.046	0.054
D	9.830	10.330	0.387	0.407
E	8.500	8.900	0.335	0.350
E1	12.050	12.650	0.474	0.498
e	5.080 TYP		0.200 TYP	
F	2.540	2.940	0.100	0.116
h	0.100 TYP		0.004 TYP	
L	13.300	13.800	0.523	0.543
L1	3.540	3.940	0.139	0.155
Φ	3.735	3.935	0.147	0.155