

# TO-220-3L/TO-220F Plastic-Encapsulate Diodes

## MUR1660CT、MURF1660CT SUPER FAST RECOVER RECTIFIER

### MAIN CHARACTERISTICS

$I_o$	16A
$V_{RRM}$	600 V
$T_j$	150 °C
$V_{F(typ)}$	1.17V (@ $T_j=125^{\circ}C$ )

### FEATURES

- Ultrafast 35ns Recovery Times
- High Voltage Capability to 600V
- Low Reverse Leakage Current

### MARKING

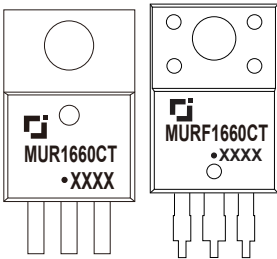

MUR(F)1660CT = Device code  
 Solid dot = Green molding compound device  
 if none, the normal device  
 XXXX = Code

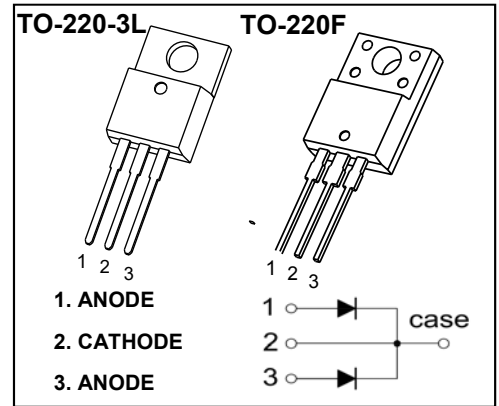

### MAXIMUM RATINGS ( $T_a=25^{\circ}C$ unless otherwise noted )

Symbol	Parameter	MUR		Unit
		1660CT	F1660CT	
$V_{RRM}$	Peak repetitive reverse voltage	600		V
$V_{RWM}$	Working peak reverse voltage			
$V_R$	DC blocking voltage			
$V_{R(RMS)}$	RMS reverse voltage	420		V
$I_o$	Average rectified output current@ Per leg	8		A
	Average rectified output current@ Total device	16		A
$I_{FSM}$	Non-Repetitive peak forward surge current 8.3ms half sine wave	110		A
$P_D$	Power dissipation	2.0		W
$R_{\theta JA}$	Thermal resistance from junction to ambient	62.5		°C/W
$T_j$	Operating Junction Temperature Range	-55 ~ +150		°C
$T_{stg}$	Storage Temperature Range	-55 ~ +150		°C

### ELECTRICAL CHARACTERISTICS ( $T_a=25^{\circ}C$ unless otherwise specified )

Parameter	Symbol	Test conditions	Min	Typ	Max	Unit
Reverse voltage	$V_{(BR)}$	$I_R=100\mu A$	600			V
Reverse current	$I_R$	$V_R=600V$	$T_j = 25^{\circ}C$	0.1	1	$\mu A$
			$T_j = 125^{\circ}C$	2.0		$\mu A$
Forward voltage	$V_F$	$I_F=8.0A$	$T_j = 25^{\circ}C$	1.35	1.6	V
			$T_j = 125^{\circ}C$	1.17		V
Typical total capacitance	$C_{tot}$	$V_R=4.0V, f=1MHz$		28		pF
Reverse recovery time	$t_{rr}$	$I_F=0.5A, I_R=1A, I_{tr}=0.25A$			35	ns

# Typical Characteristics

Forward Characteristics

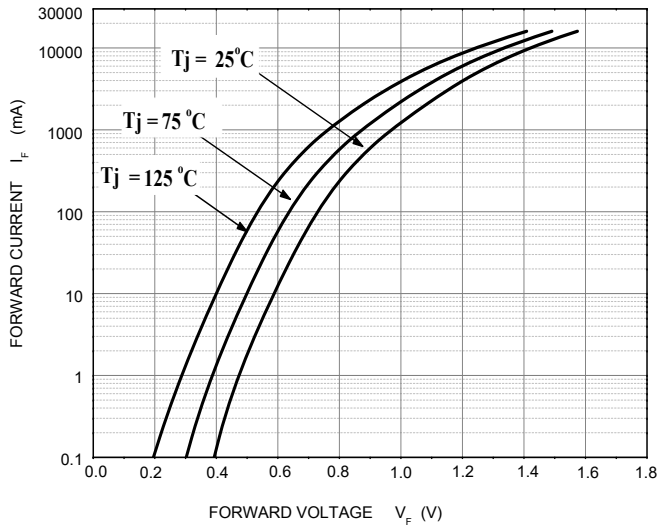

Reverse Characteristics

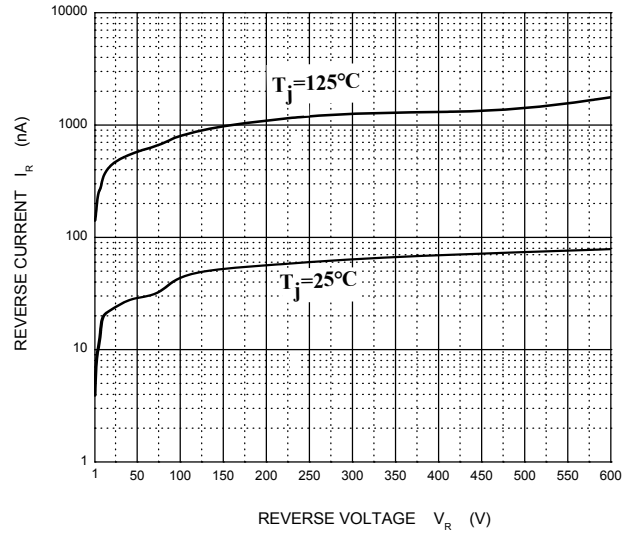

Capacitance Characteristics

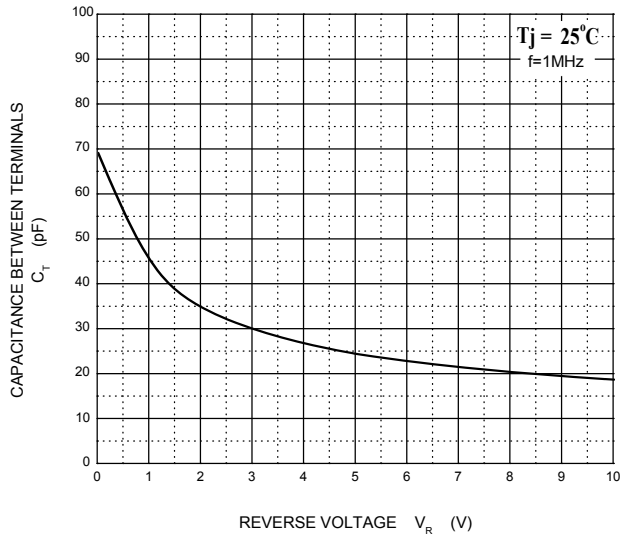

Power Derating Curve

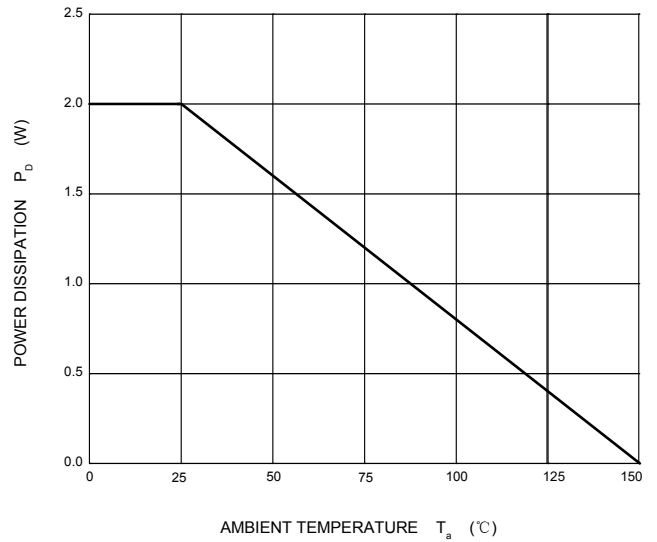
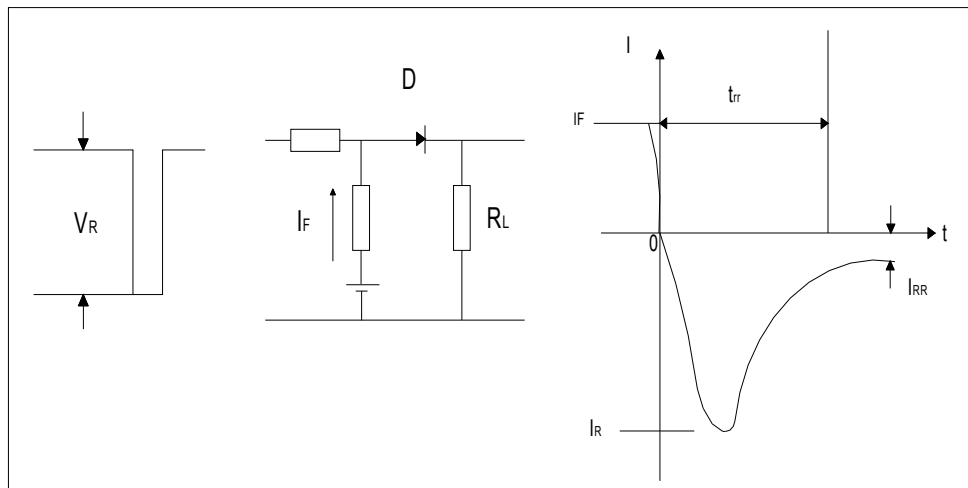

Diagram of circuit and Testing wave form of reverse recovery time



# TO-220-3L Package Outline Dimensions



Symbol	Dimensions In Millimeters		Dimensions In Inches	
	Min	Max	Min	Max
A	4.450	4.750	0.175	0.187
A1	2.520	2.820	0.099	0.111
b	0.710	0.910	0.028	0.036
b1	1.170	1.370	0.046	0.054
c	0.300	0.500	0.012	0.020
c1	1.170	1.370	0.046	0.054
D	9.830	10.330	0.387	0.407
E	8.500	8.900	0.335	0.350
E1	12.050	12.650	0.474	0.498
e	2.540 TYP		0.100 TYP	
e1	4.900	5.200	0.192	0.205
F	2.540	2.940	0.100	0.116
h	0.100 TYP		0.004 TYP	
L	13.300	13.800	0.523	0.543
L1	3.540	3.940	0.139	0.155
$\Phi$	3.735	3.935	0.147	0.155

# TO-220F Package Outline Dimensions



Symbol	Dimensions In Millimeters		Dimensions In Inches	
	Min.	Max.	Min.	Max.
A	4.300	4.700	0.169	0.185
A1	1.300 REF.		0.051 REF.	
A2	2.800	3.200	0.110	0.126
A3	2.500	2.900	0.098	0.114
b	0.500	0.750	0.020	0.030
b1	1.100	1.350	0.043	0.053
b2	1.500	1.750	0.059	0.069
c	0.500	0.750	0.020	0.030
D	9.960	10.360	0.392	0.408
E	14.800	15.200	0.583	0.598
e	2.540 TYP.		0.100 TYP.	
F	2.700 REF.		0.106 REF.	
$\Phi$	3.300	3.700	0.130	0.146
L	28.000	28.400	1.102	1.118
L1	1.700	1.900	0.067	0.075
L2	0.900	1.100	0.035	0.043