



## TO-252-2L Plastic-Encapsulate Diode

**MURD10H60CTB** HYPERFAST RECTIFIER,FRED

### MAIN CHARACTERISTICS

$I_o$	<b>10(5×2)A</b>
$V_{RRM}$	<b>600V</b>
$T_{rr}$	<b>22ns</b>
$T_j$	<b>175℃</b>
$V_{F(typ)}$	<b>1.0V(@<math>T_j=150℃</math>)</b>

### FEATURES

- Ultrafast Recovery Times and Low Recovery Loss
- Low Forward Voltage
- Low Reverse Leakage Current

### APPLICATIONS

Specifically designed to improve efficiency of PFC and output rectification stages of EV / HEV battery charging stations, booster stage of solar inverters and UPS applications, these devices are perfectly matched to operate with MOSFETs or high speed IGBTs.

### MARKING



MURD10H60CTB = Device code  
 Solid dot = Green molding compound device  
 if none, the normal device  
 XXXX = Code

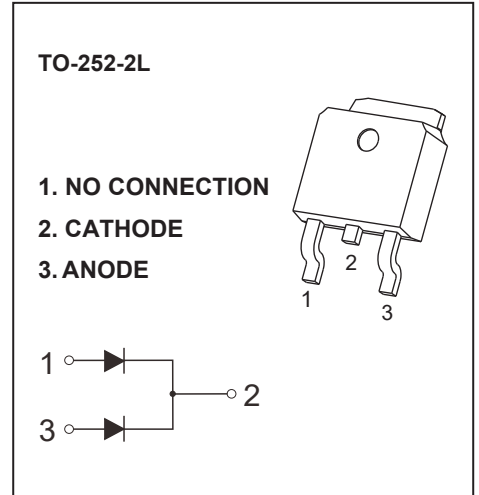

### MAXIMUM RATINGS ( $T_c=25℃$ unless otherwise noted )

Symbol	Parameter	MURD10H60CTB	Unit
$V_{RRM}$	Peak Repetitive Reverse Voltage	600	V
$V_R$	DC Blocking Voltage		
$I_{F(AV)}$	Average rectified output current@ Per leg( $T_c=158℃$ )	5	A
	Average rectified output current@ Total device( $T_c=158℃$ )	10	
$I_{F(RMS)}$	RMS Forward Current( $T_c=158℃$ )	7	A
$I_{FSM}$	Non-Repetitive Surge Forward Current (8.3ms)	77	A
$P_D$	Power dissipation	107	W
$R_{\theta JC}$	Thermal Resistance From Junction to Case	1.4	℃/W
$T_j$	Operating Junction Temperature Range	-55 ~ +175	℃
$T_{stg}$	Storage Temperature Range	-55 ~ +175	℃

# Typical Characteristics

## ELECTRICAL CHARACTERISTICS ( $T_c=25^\circ\text{C}$ unless otherwise specified)

Symbol	Parameter	Test Conditions	Min.	Typ.	Max.	Unit
$V_{(BR)}$	Reverse Voltage	$I_R=100\mu\text{A}$	600			V
$I_R$	Reverse Current	$V_R=600\text{V}$	$T_j=25^\circ\text{C}$		10	$\mu\text{A}$
			$T_j=150^\circ\text{C}$		500	$\mu\text{A}$
$V_F$	Forward Voltage	$I_F=5\text{A}$	$T_j=25^\circ\text{C}$	1.1	1.6	V
			$T_j=150^\circ\text{C}$	1.0		V
$C_{tot}$	Total Capacitance	$V_R=200\text{V}, f=1\text{MHz}$		5.3		pF
$t_{rr}$	Reverse Recovery time	$I_F=0.5\text{A}, I_R=1\text{A}, I_{rr}=0.25\text{A}$		34		ns
		$I_F=1\text{A}, V_R=30\text{V}, di_F/dt = 200\text{A}/\mu\text{s}$		22		ns

## ELECTRICAL CHARACTERISTICS ( $T_c=25^\circ\text{C}$ unless otherwise specified)

Symbol	Parameter	Test Conditions	Min.	Typ.	Max.	Unit
$t_{rr}$	Reverse Recovery Time	$I_F=10\text{A}, V_R=400\text{V}, di_F/dt=200\text{A}/\mu\text{s}$		85		ns
$I_{RRM}$	Max. Reverse Recovery Current			4.7		A
$Q_{rr}$	Reverse Recovery Charge			250		nC
$t_{rr}$	Reverse Recovery Time	$I_F=10\text{A}, V_R=400\text{V}, di_F/dt=200\text{A}/\mu\text{s}, T_j=125^\circ\text{C}$		113		ns
$I_{RRM}$	Max. Reverse Recovery Current			7.0		A
$Q_{rr}$	Reverse Recovery Charge			500		nC
$t_{rr}$	Reverse Recovery Time	$I_F=10\text{A}, V_R=400\text{V}, di_F/dt=600\text{A}/\mu\text{s}, T_j=125^\circ\text{C}$		70		ns
$I_{RRM}$	Max. Reverse Recovery Current			16		A
$Q_{rr}$	Reverse Recovery			665		nC

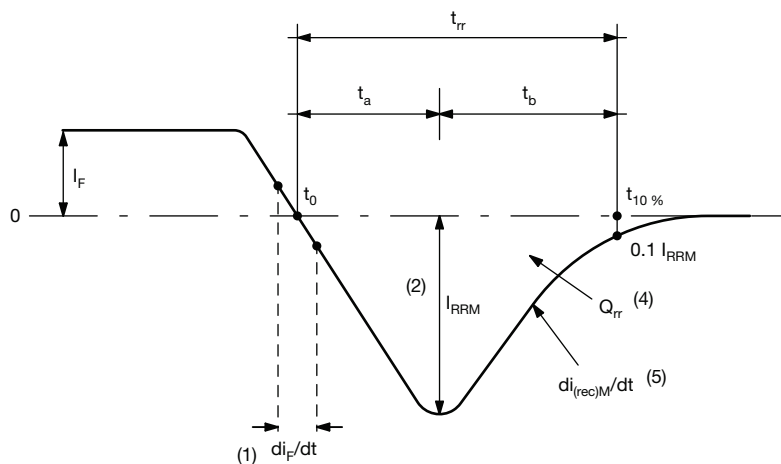

Reverse Recovery Waveform and Definitions

### Forward Characteristics

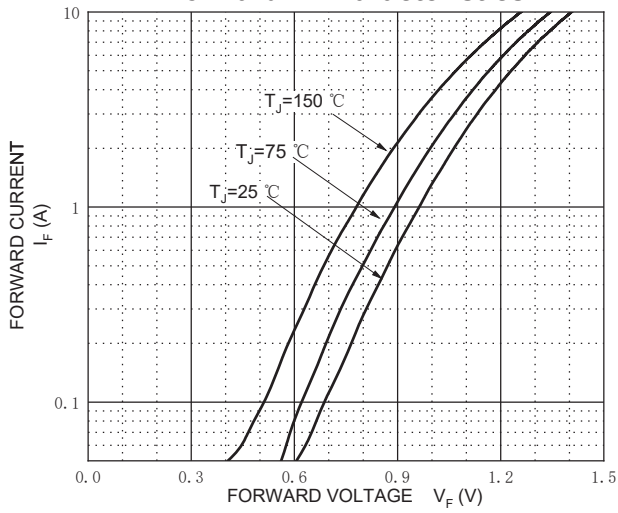

### Reverse Characteristics

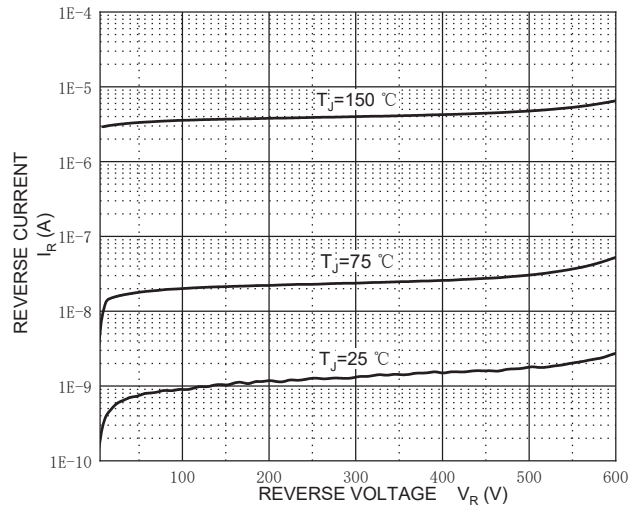

### Capacitance Characteristics Per Diode

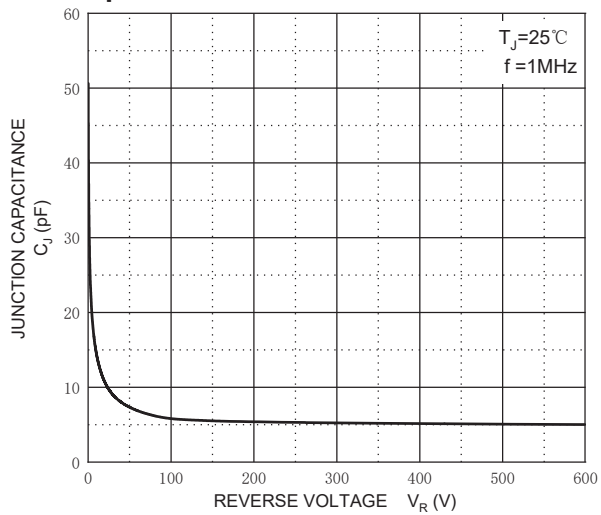

### Recovery Current vs. $di_F/dt$

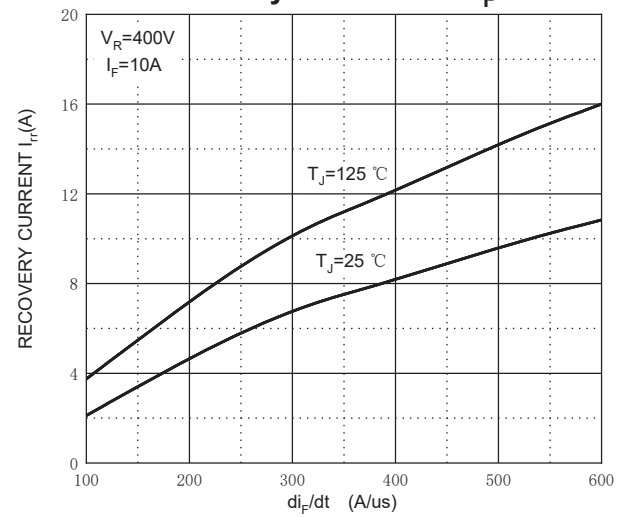

### Reverse Recovery Time vs. $di_F/dt$

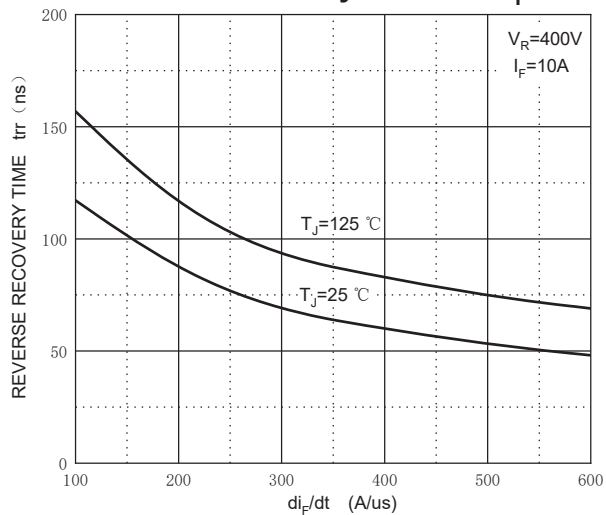

### Stored Charge vs. $di_F/dt$

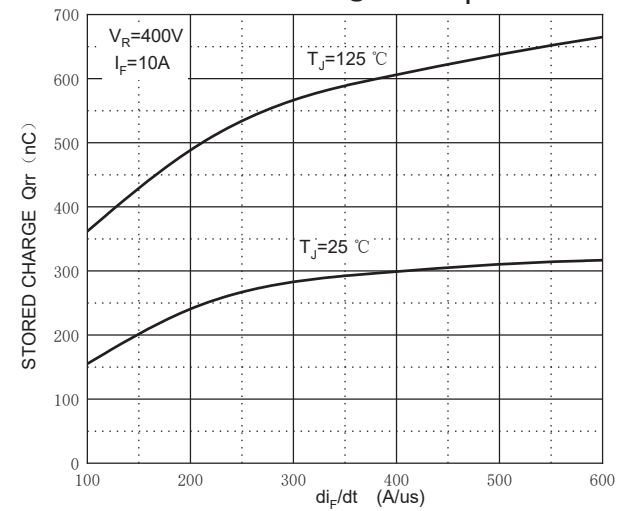

### Dynamic Parameters vs. Junction Temperature

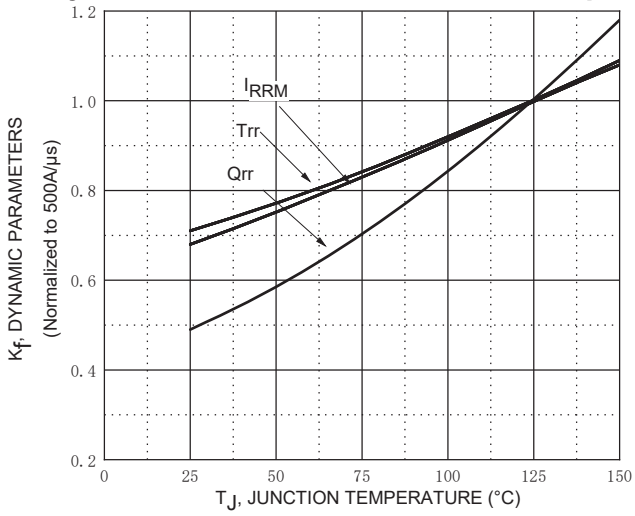

### Current Derating

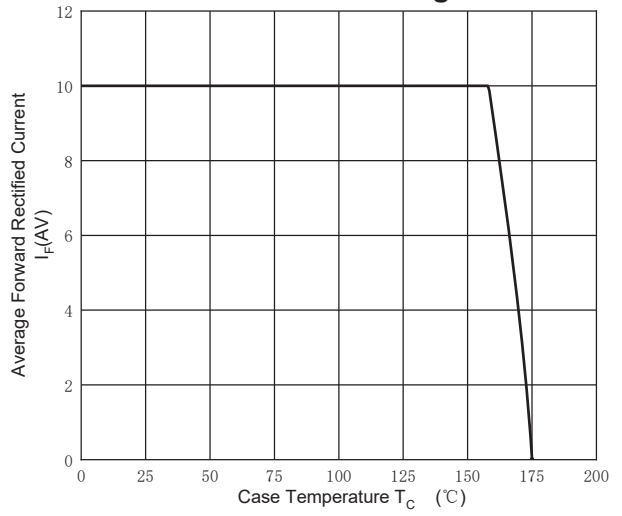

### MURB10H60CTB Transient Thermal Impedance, Junction-Case

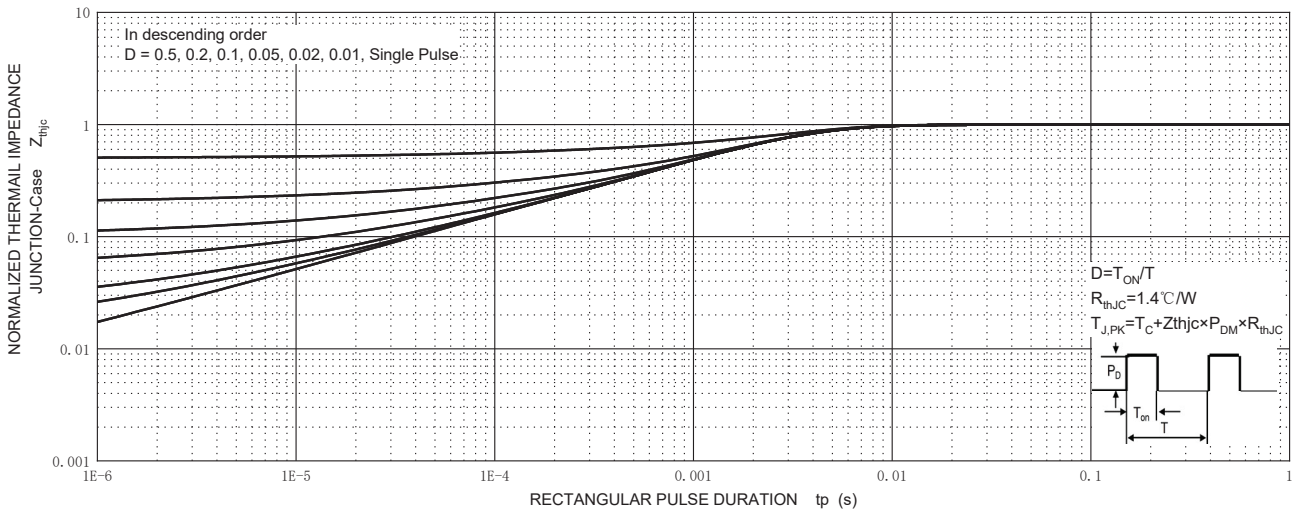

## TO-252-2L Package Outline Dimensions

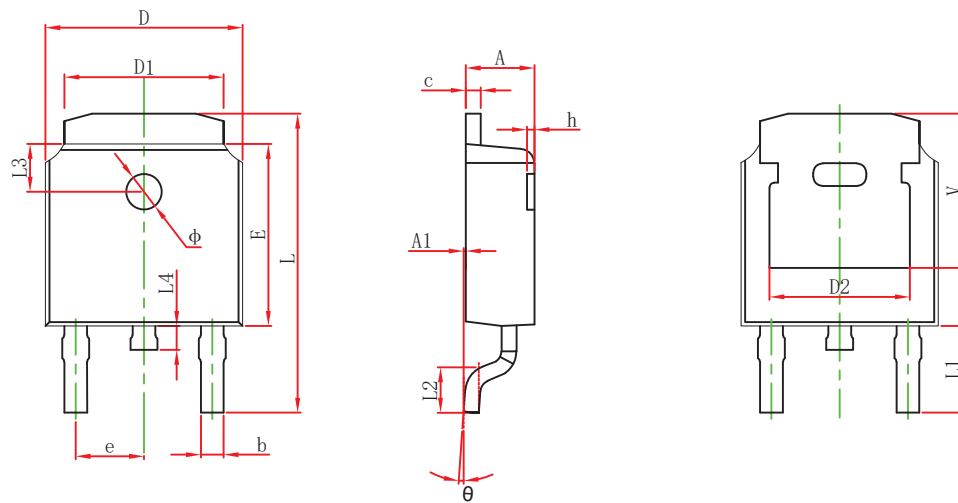

Symbol	Dimensions In Millimeters		Dimensions In Inches	
	Min.	Max.	Min.	Max.
A	2.200	2.400	0.087	0.094
A1	0.000	0.127	0.000	0.005
b	0.635	0.770	0.025	0.030
c	0.460	0.580	0.018	0.023
D	6.500	6.700	0.256	0.264
D1	5.100	5.460	0.201	0.215
D2	4.830 REF.		0.190 REF.	
E	6.000	6.200	0.236	0.244
e	2.186	2.386	0.086	0.094
L	9.712	10.312	0.382	0.406
L1	2.900 REF.		0.114 REF.	
L2	1.400	1.700	0.055	0.067
L3	1.600 REF.		0.063 REF.	
L4	0.600	1.000	0.024	0.039
$\Phi$	1.100	1.300	0.043	0.051
$\theta$	0°	8°	0°	8°
h	0.000	0.300	0.000	0.012
V	5.250 REF.		0.207 REF.	

## TO-252-2L Suggested Pad Layout

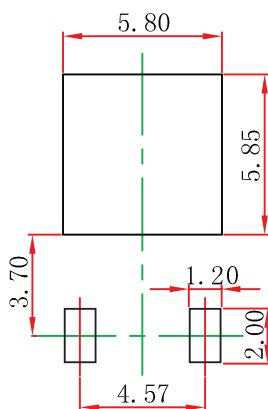

### Note:

1. Controlling dimension: in millimeters.
2. General tolerance:  $\pm 0.05$  mm.
3. The pad layout is for reference purposes only.

### NOTICE

JSCJ reserves the right to make modifications, enhancements, improvements, corrections or other changes without further notice to any product herein. JSCJ does not assume any liability arising out of the application or use of any product described herein.

# TO-252-2L Tape and Reel

## TO-252-2L Embossed Carrier Tape



### Packaging Description:

TO-252-2L parts are shipped in tape. The carrier tape is made from a dissipative (carbon filled) polycarbonate resin. The cover tape is a multilayer film (Hear Activated Adhesive in nature) primarily composed of polyester film, adhesive layer, sealant, and anti-static sprayed agent. These reeled parts in standard option are shipped with 2500 units per 13" or 33.0 cm diameter reel. The reels are clear in color and is made of polystyrene plastic (anti-static coated).

Dimensions are in millimeter										
Pkg type	A	B	C	d	E	F	P0	P	P1	W
TO-252	6.90	10.50	2.70	Φ1.55	1.75	7.50	4.00	8.00	2.00	16.00

## TO-252-2L Tape Leader and Trailer

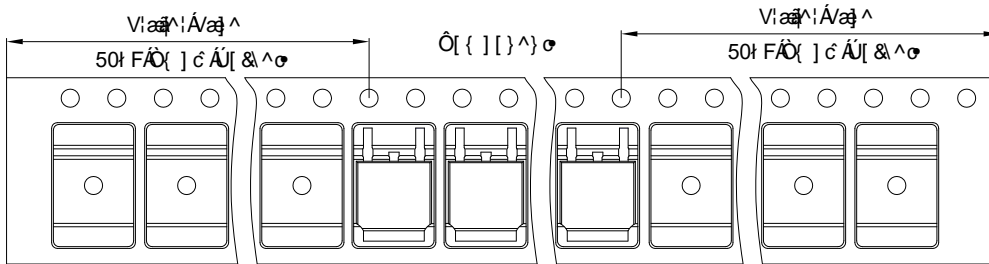

## TO-252-2L Reel



Dimensions are in millimeter						
Reel	D	D1	D2	W1	W2	l
13" Dia	330.00	100.00	Φ21.00	16.40	21.40	Φ13.00

Reel	Reel Size	Box	Box Size(mm)	Carton	Carton Size(mm)
2500 pcs	13 inch	5000 pcs	360×360×65	25000 pcs	378×358×382