

TO-252-2L Plastic-Encapsulate Diode

MURD10HS65 HYPERFAST RECTIFIER, FRED

MAIN CHARACTERISTICS

I_o	10A
V_{RRM}	650V
T_{rr}	15ns
T_j	175°C
$V_{F(typ)}$	1.4V(@$T_j=150°C$)

FEATURES

- Ultrafast Recovery Times and Low Recovery Loss
- Low Forward Voltage
- Low Reverse Leakage Current

APPLICATIONS

Specifically designed to improve efficiency of PFC and output rectification stages of EV / HEV battery charging stations, booster stage of solar inverters and UPS applications, these devices are perfectly matched to operate with MOSFETs or high speed IGBTs.

MARKING

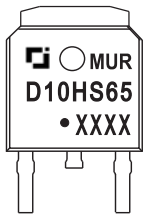

MURD10HS65 = Device code
 Solid dot = Green molding compound device
 if none, the normal device
 XXXX = Code

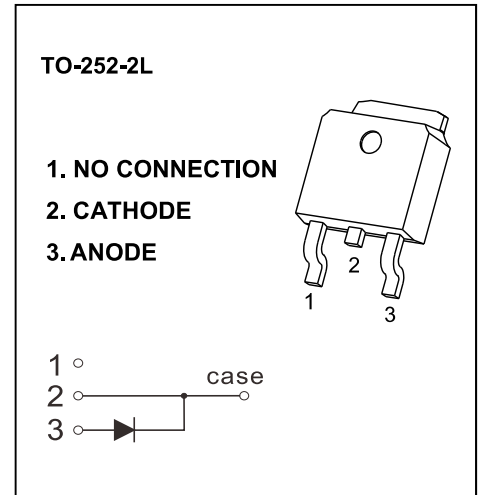

MAXIMUM RATINGS ($T_c=25°C$ unless otherwise noted)

Symbol	Parameter	MURD10HS65	Unit
V_{RRM}	Peak Repetitive Reverse Voltage	650	V
V_R	DC Blocking Voltage		
$I_{F(AV)}$	Average Forward Current($T_c=154°C$)	10	A
$I_{F(RMS)}$	RMS Forward Current($T_c=154°C$)	14	A
I_{FSM}	Non-Repetitive Surge Forward Current (8.3ms)	92	A
P_D	Power dissipation	100	W
$R_{\theta JC}$	Thermal Resistance From Junction to Case	1.5	°C/W
T_j	Operating Junction Temperature Range	-55 ~ +175	°C
T_{stg}	Storage Temperature Range	-55 ~ +175	°C

Typical Characteristics

ELECTRICAL CHARACTERISTICS ($T_c=25^\circ\text{C}$ unless otherwise specified)

Symbol	Parameter	Test Conditions	Min.	Typ.	Max.	Unit
$V_{(BR)}$	Reverse Voltage	$I_R=100\mu\text{A}$	650			V
I_R	Reverse Current	$V_R=650\text{V}$	$T_j=25^\circ\text{C}$		5	μA
			$T_j=150^\circ\text{C}$		500	μA
V_F	Forward Voltage	$I_F=10\text{A}$	$T_j=25^\circ\text{C}$	2.0	2.2	V
			$T_j=150^\circ\text{C}$	1.4		V
C_{tot}	Total Capacitance	$V_R=200\text{V}, f=1\text{MHz}$		8.8		pF
t_{rr}	Reverse Recovery time	$I_F=0.5\text{A}, I_R=1\text{A}, I_{rr}=0.25\text{A}$		15		ns
		$I_F=1\text{A}, V_R=30\text{V}, di_F/dt = 200\text{A}/\mu\text{s}$		15		ns

ELECTRICAL CHARACTERISTICS ($T_c=25^\circ\text{C}$ unless otherwise specified)

Symbol	Parameter	Test Conditions	Min.	Typ.	Max.	Unit
t_{rr}	Reverse Recovery Time	$I_F=10\text{A}, V_R=400\text{V}, di_F/dt=200\text{A}/\mu\text{s}$		28		ns
I_{RRM}	Max. Reverse Recovery Current			3		A
Q_{rr}	Reverse Recovery Charge			50		nC
t_{rr}	Reverse Recovery Time	$I_F=10\text{A}, V_R=400\text{V}, di_F/dt=200\text{A}/\mu\text{s}, T_j=125^\circ\text{C}$		87		ns
I_{RRM}	Max. Reverse Recovery Current			5		A
Q_{rr}	Reverse Recovery Charge			294		nC
t_{rr}	Reverse Recovery Time	$I_F=10\text{A}, V_R=400\text{V}, di_F/dt=600\text{A}/\mu\text{s}, T_j=125^\circ\text{C}$		49		ns
I_{RRM}	Max. Reverse Recovery Current			13		A
Q_{rr}	Reverse Recovery Charge			372		nC

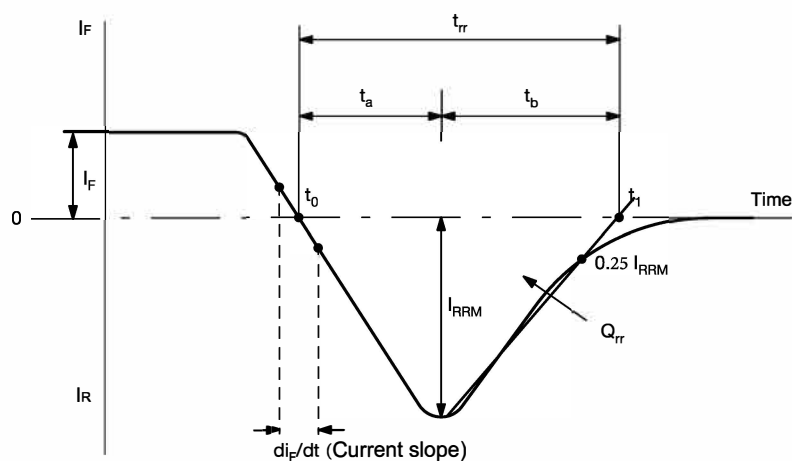

Reverse Recovery Waveform and Definitions

Typical Characteristics

Forward Characteristics

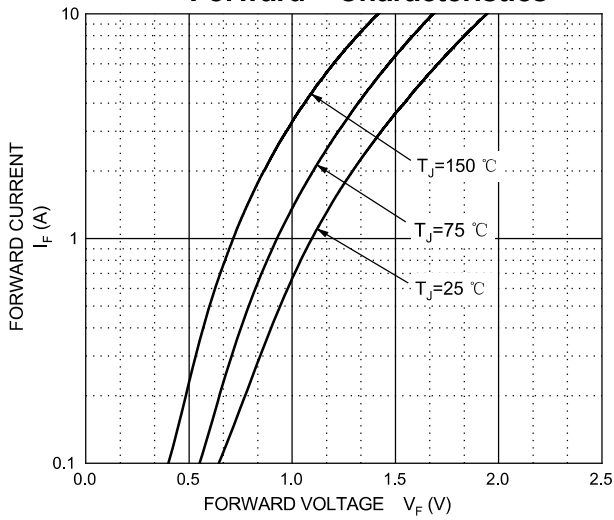

Reverse Characteristics

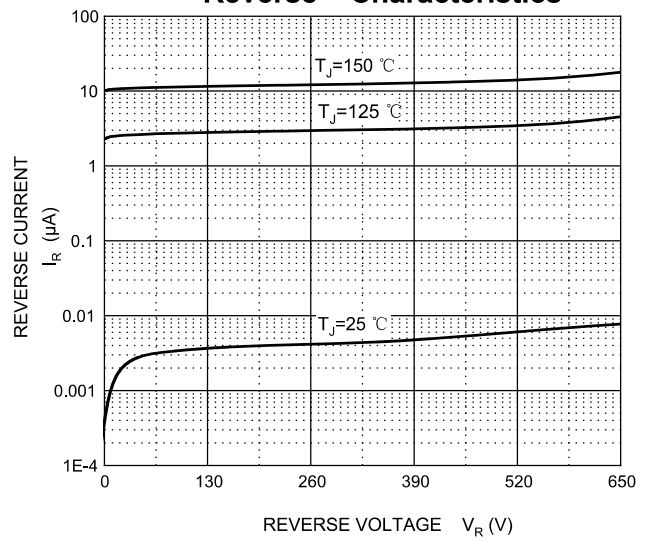

Capacitance Characteristics

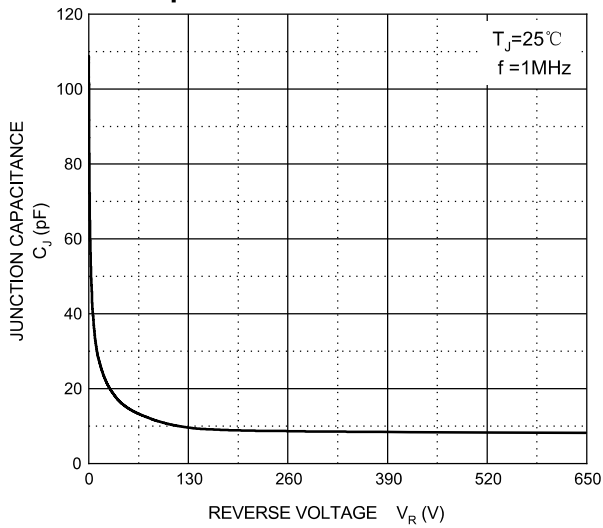

Recovery Current vs. di_F/dt

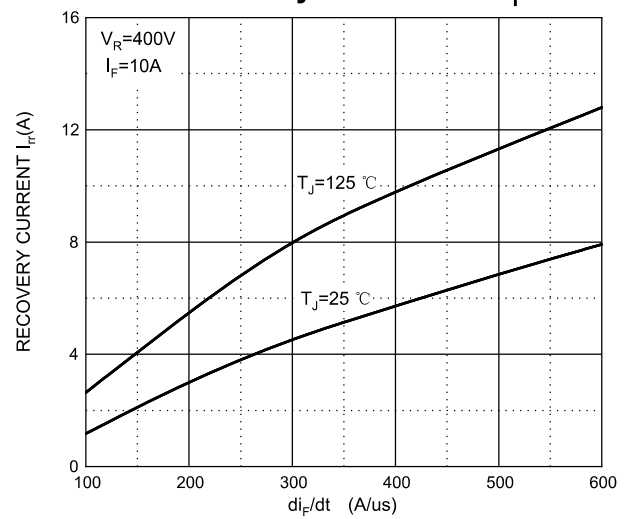

Reverse Recovery Time vs. di_F/dt

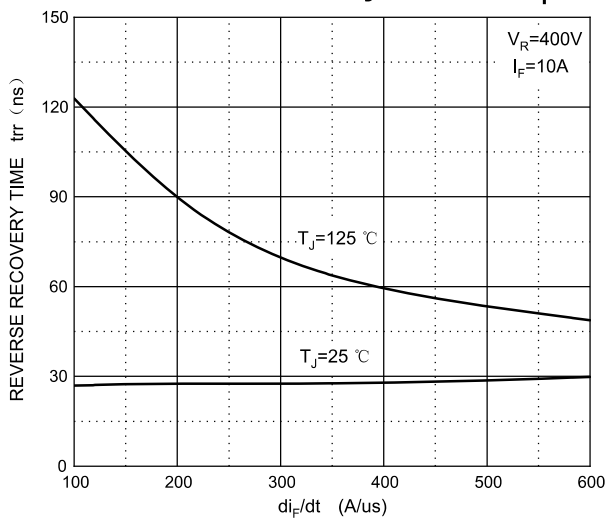

Stored Charge vs. di_F/dt

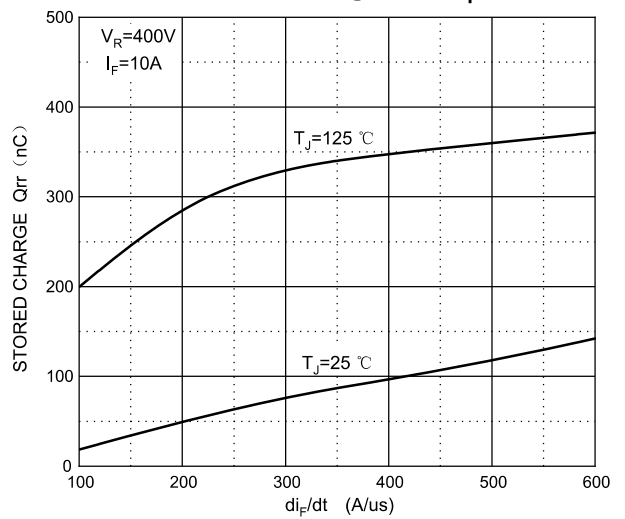

Typical Characteristics

Dynamic Parameters vs. Junction Temperature

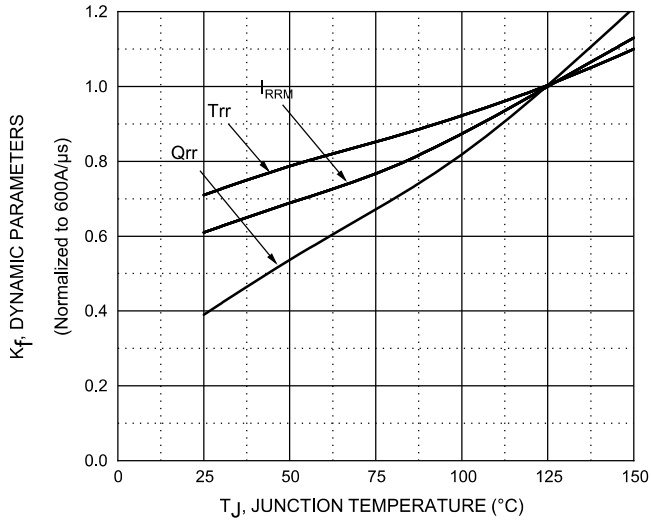

Current Derating

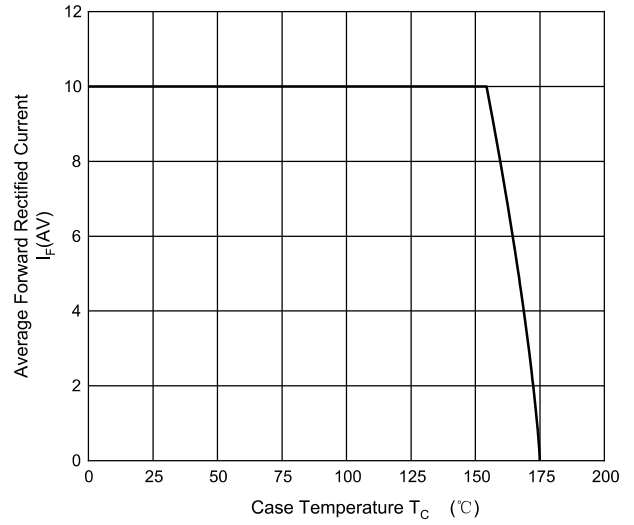

MURD10HS65 Transient Thermal Impedance, Junction-Case

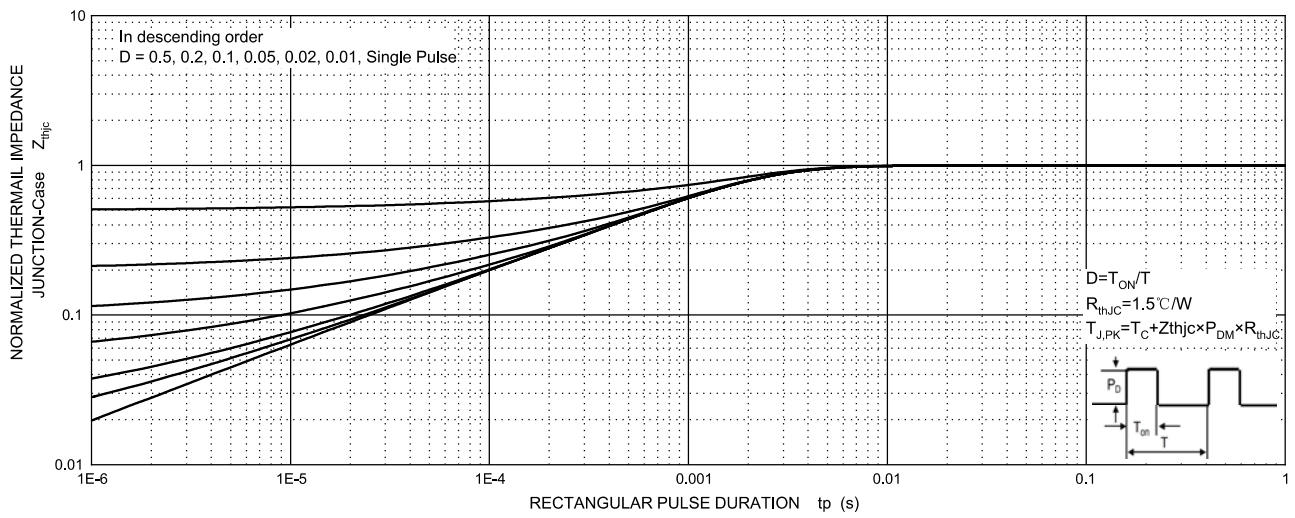

TO-252-2L Package Outline Dimensions

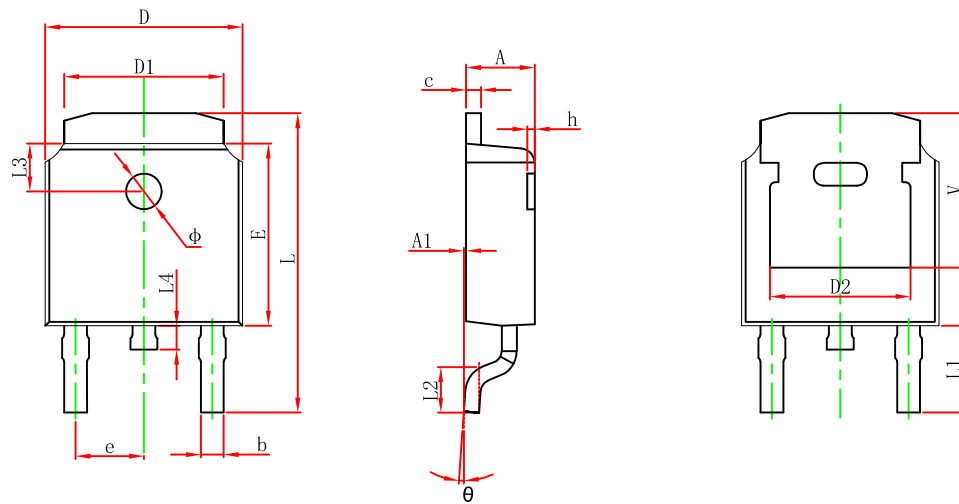

Symbol	Dimensions In Millimeters		Dimensions In Inches	
	Min.	Max.	Min.	Max.
A	2.200	2.400	0.087	0.094
A1	0.000	0.127	0.000	0.005
b	0.635	0.770	0.025	0.030
c	0.460	0.580	0.018	0.023
D	6.500	6.700	0.256	0.264
D1	5.100	5.460	0.201	0.215
D2	4.830 REF.		0.190 REF.	
E	6.000	6.200	0.236	0.244
e	2.186	2.386	0.086	0.094
L	9.712	10.312	0.382	0.406
L1	2.900 REF.		0.114 REF.	
L2	1.400	1.700	0.055	0.067
L3	1.600 REF.		0.063 REF.	
L4	0.600	1.000	0.024	0.039
Φ	1.100	1.300	0.043	0.051
θ	0°	8°	0°	8°
h	0.000	0.300	0.000	0.012
V	5.250 REF.		0.207 REF.	

TO-252-2L Suggested Pad Layout

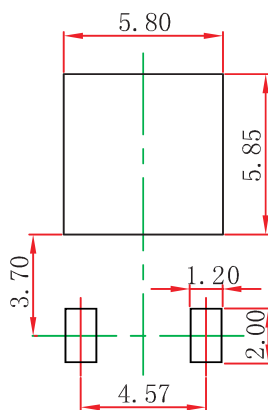

Note:

1. Controlling dimension: in millimeters.
2. General tolerance: $\pm 0.05\text{mm}$.
3. The pad layout is for reference purposes only.

NOTICE

JSCJ reserves the right to make modifications, enhancements, improvements, corrections or other changes without further notice to any product herein. JSCJ does not assume any liability arising out of the application or use of any product described herein.

TO-252-2L Tape and Reel

TO-252-2L Embossed Carrier Tape

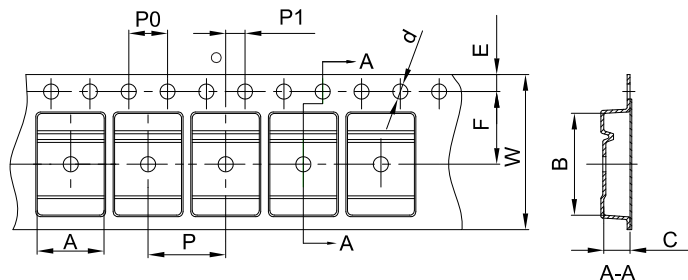

Packaging Description:

TO-252-2L parts are shipped in tape. The carrier tape is made from a dissipative (carbon filled) polycarbonate resin. The cover tape is a multilayer film (Hear Activated Adhesive in nature) primarily composed of polyester film, adhesive layer, sealant, and anti-static sprayed agent. These reeled parts in standard option are shipped with 2500 units per 13" or 33.0 cm diameter reel. The reels are clear in color and is made of polystyrene plastic (anti-static coated).

Dimensions are in millimeter										
Pkg type	A	B	C	d	E	F	P0	P	P1	W
TO-252	6.90	10.50	2.70	Φ1.55	1.75	7.50	4.00	8.00	2.00	16.00

TO-252-2L Tape Leader and Trailer

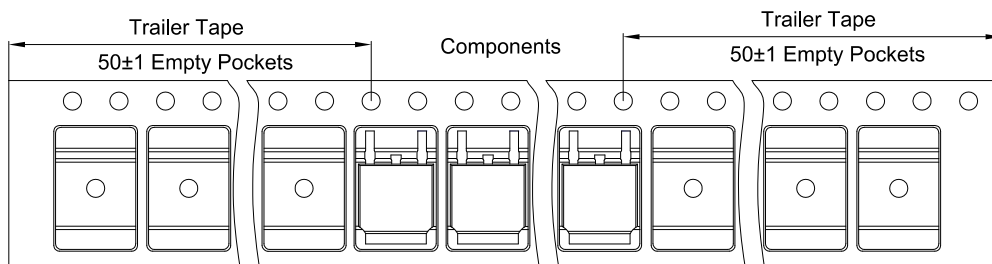

TO-252-2L Reel

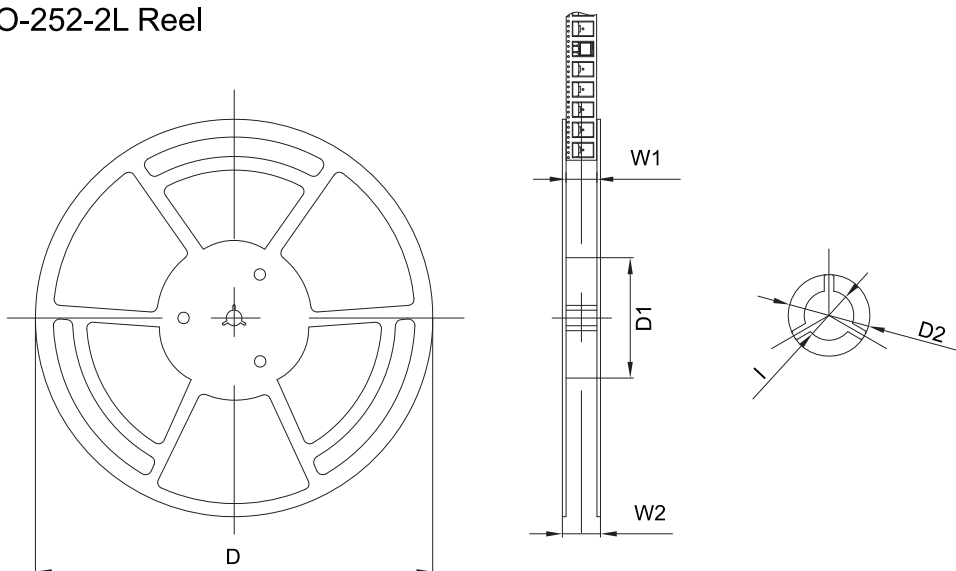

Dimensions are in millimeter						
Reel	D	D1	D2	W1	W2	I
13" Dia	330.00	100.00	Φ21.00	16.40	21.40	Φ13.00

Reel	Reel Size	Box	Box Size(mm)	Carton	Carton Size(mm)
2500 pcs	13 inch	5000 pcs	360×360×65	25000 pcs	378×358×382