

**TO-247-2L Plastic-Encapsulate Diode****MURW75H60L** HYPERFAST RECTIFIER,FRED**MAIN CHARACTERISTICS**

$I_o$	<b>75A</b>
$V_{RRM}$	<b>600V</b>
$T_{rr}$	<b>36ns</b>
$T_j$	<b>175°C</b>
$V_{F(typ)}$	<b>1.1V(@<math>T_j=150^\circ\text{C}</math>)</b>

**FEATURES**

- Ultrafast Recovery Times and Low Recovery Loss
- Low Forward Voltage
- Low Reverse Leakage Current

**APPLICATIONS**

Specifically designed to improve efficiency of PFC and output rectification stages of EV / HEV battery charging stations, booster stage of solar inverters and UPS applications, these devices are perfectly matched to operate with MOSFETs or high speed IGBTs.

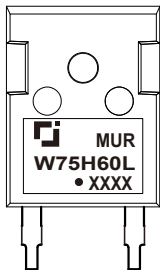
**MARKING**

MURW75H60L= Device code  
 Solid dot = Green molding compound device  
 if none, the normal device  
 XXXX = Code

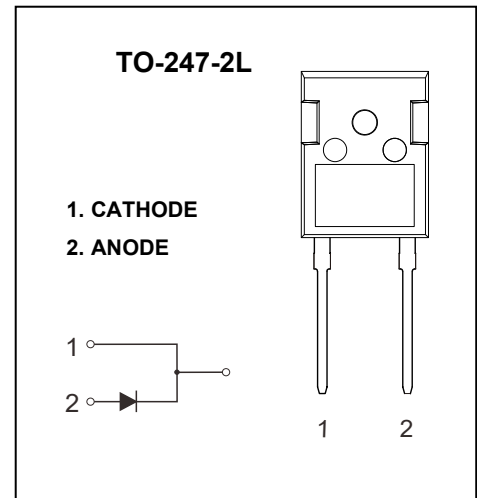
**MAXIMUM RATINGS (  $T_c=25^\circ\text{C}$  unless otherwise noted )**

Symbol	Parameter	MURW75H60L	Unit
$V_{RRM}$	Peak Repetitive Reverse Voltage	600	V
$V_R$	DC Blocking Voltage		
$I_{F(AV)}$	Average Forward Current( $T_c=126^\circ\text{C}$ )	75	A
$I_{F(RMS)}$	RMS Forward Current( $T_c=126^\circ\text{C}$ )	106	A
$I_{FSM}$	Non-Repetitive Surge Forward Current (8.3ms )	664	A
$P_D$	Power dissipation	250	W
$R_{\theta JC}$	Thermal Resistance From Junction to Case	0.6	$^\circ\text{C}/\text{W}$
$T_j$	Operating Junction Temperature Range	-55 ~ +175	$^\circ\text{C}$
$T_{stg}$	Storage Temperature Range	-55 ~ +175	$^\circ\text{C}$

# Typical Characteristics

## ELECTRICAL CHARACTERISTICS ( $T_c=25^\circ\text{C}$ unless otherwise specified)

Symbol	Parameter	Test Conditions	Min.	Typ.	Max.	Unit
$V_{(BR)}$	Reverse Voltage	$I_R=100\mu\text{A}$	600			V
$I_R$	Reverse Current	$V_R=600\text{V}$	$T_J=25^\circ\text{C}$		10	$\mu\text{A}$
			$T_J=150^\circ\text{C}$		500	$\mu\text{A}$
$V_F$	Forward Voltage	$I_F=75\text{A}$	$T_J=25^\circ\text{C}$	1.3	1.6	V
			$T_J=150^\circ\text{C}$	1.1		V
$C_{tot}$	Total Capacitance	$V_R=200\text{V}, f=1\text{MHz}$		67		pF
$t_{rr}$	Reverse Recovery time	$I_F=0.5\text{A}, I_R=1\text{A}, I_{rr}=0.25\text{A}$		48		ns
		$I_F=1\text{A}, V_R=30\text{V}, di_F/dt = 200\text{A}/\mu\text{s}$		36		ns

## ELECTRICAL CHARACTERISTICS ( $T_c=25^\circ\text{C}$ unless otherwise specified)

Symbol	Parameter	Test Conditions	Min.	Typ.	Max.	Unit
$t_{rr}$	Reverse Recovery Time	$I_F=75\text{A}, V_R=400\text{V}, di_F/dt=200\text{A}/\mu\text{s}$		86		ns
$I_{RRM}$	Max. Reverse Recovery Current			9.3		A
$Q_{rr}$	Reverse Recovery Charge			451		nC
$t_{rr}$	Reverse Recovery Time	$I_F=75\text{A}, V_R=400\text{V}, di_F/dt=200\text{A}/\mu\text{s}, T_J=125^\circ\text{C}$		158		ns
$I_{RRM}$	Max. Reverse Recovery Current			23		A
$Q_{rr}$	Reverse Recovery Charge			1884		nC
$t_{rr}$	Reverse Recovery Time	$I_F=75\text{A}, V_R=400\text{V}, di_F/dt=600\text{A}/\mu\text{s}, T_J=125^\circ\text{C}$		133		ns
$I_{RRM}$	Max. Reverse Recovery Current			46.5		A
$Q_{rr}$	Reverse Recovery Charge			3194		nC

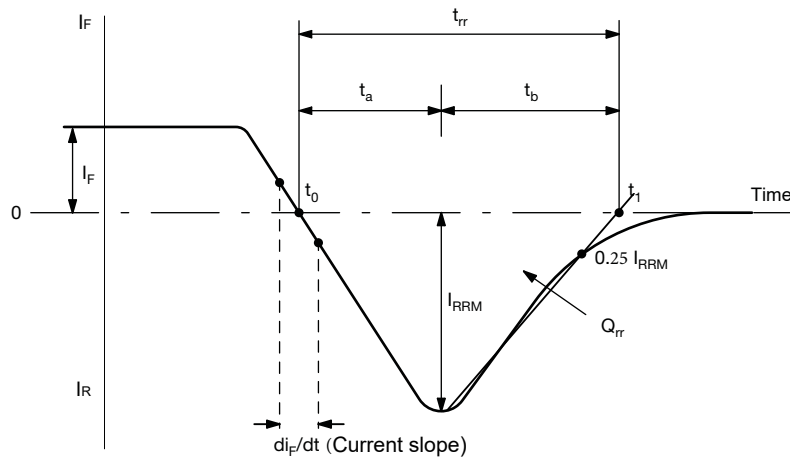

Reverse Recovery Waveform and Definitions

# Typical Characteristics

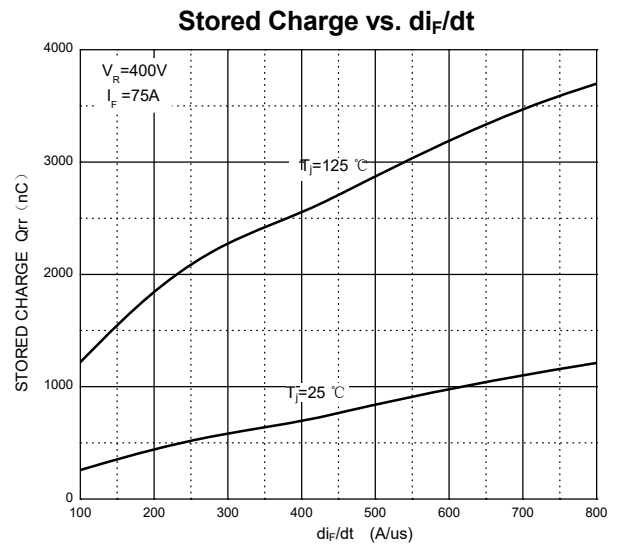
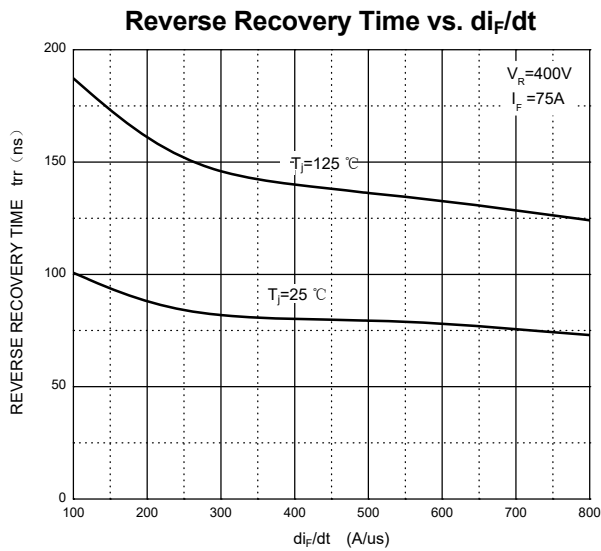
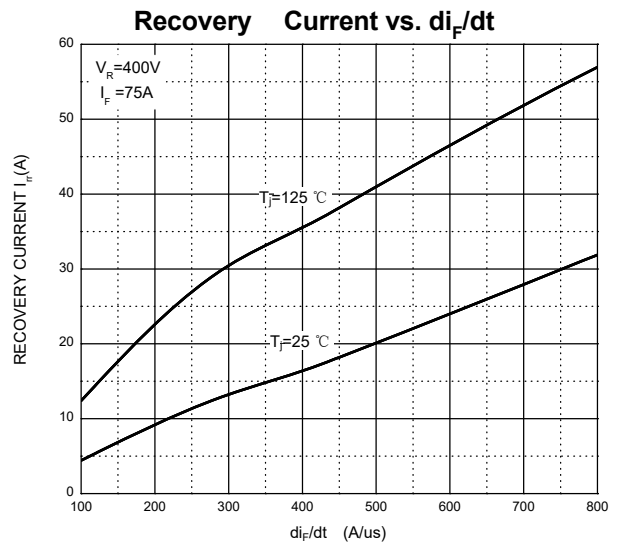
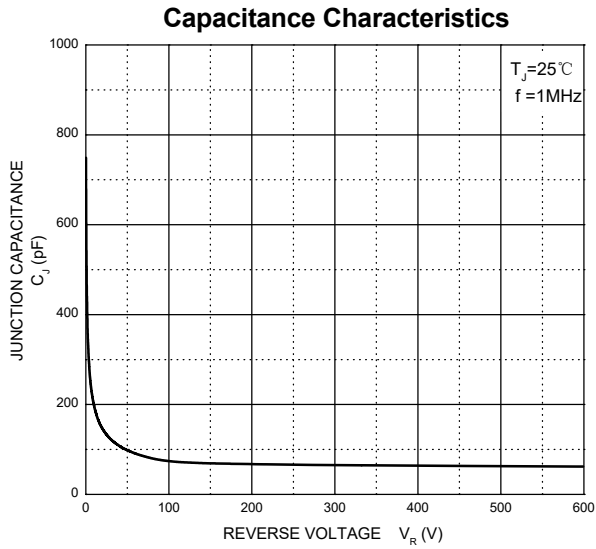
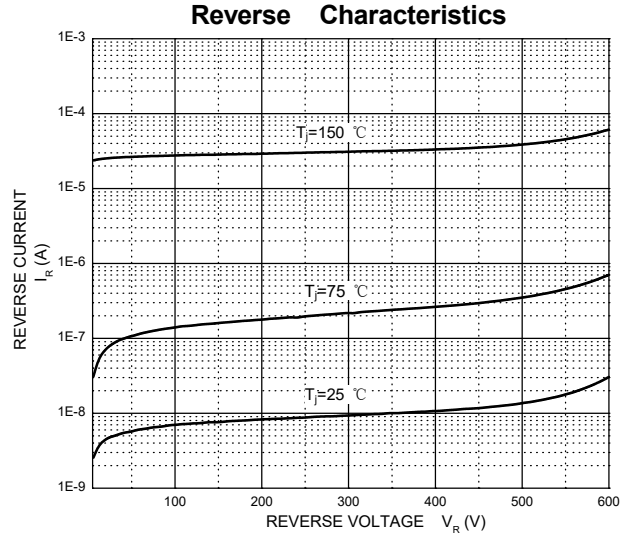
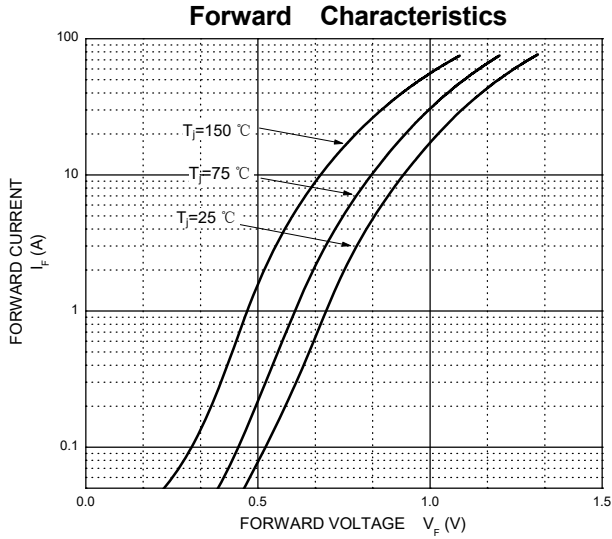

# Typical Characteristics

### Dynamic Parameters vs. Junction Temperature

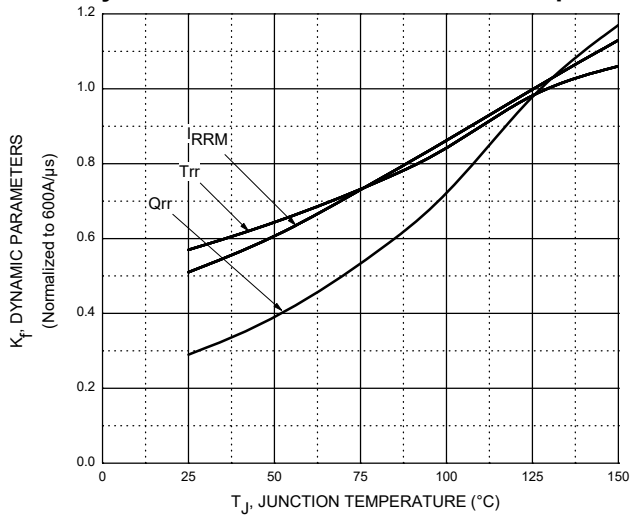

### Current Derating

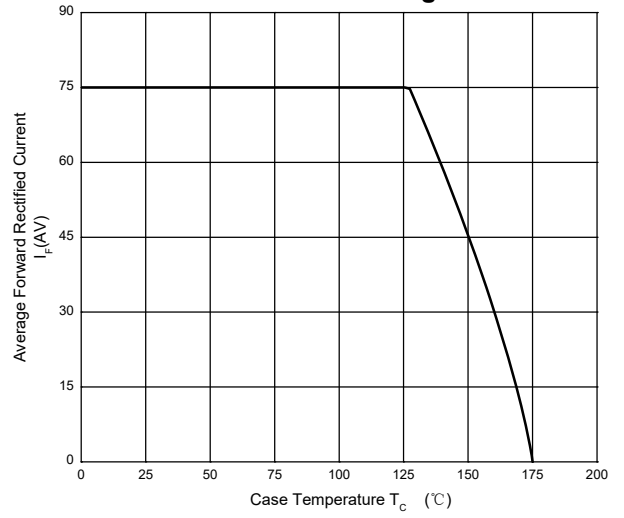

### MURW75H60L Transient Thermal Impedance, Junction-Case

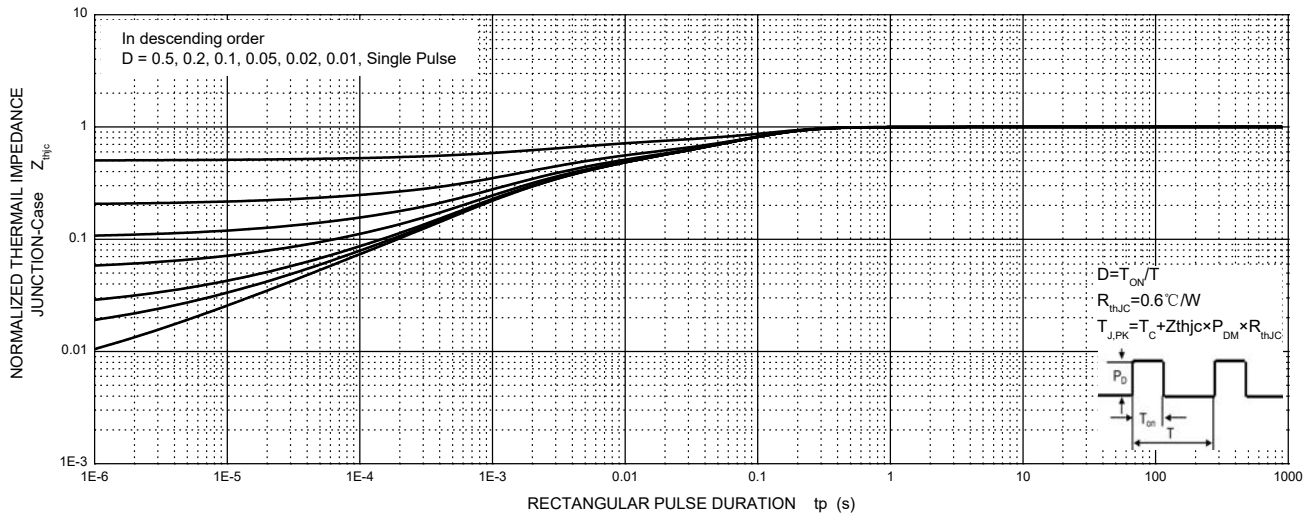

# TO-247-2L Package Outline Dimensions

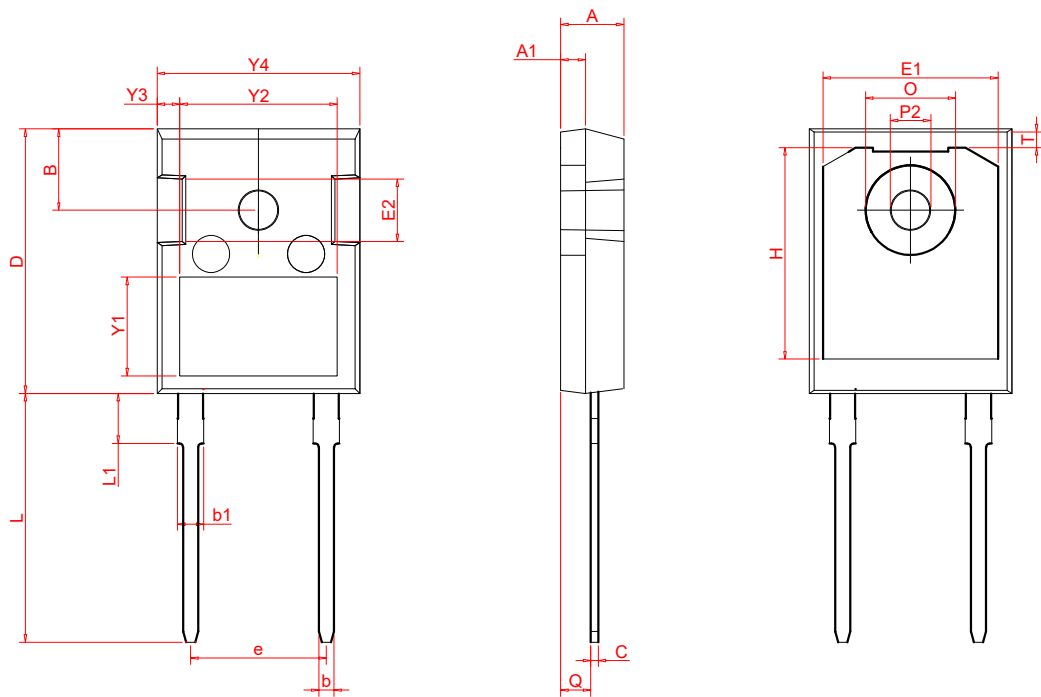

Symbol	Dimensions In Millimeters		Dimensions In Inches	
	Min	Max	Min	Max
A	4.70	5.30	0.185	0.209
A1	1.70	2.30	0.067	0.091
C	0.45	0.75	0.018	0.030
Q	2.20	2.60	0.087	0.102
O	7.10	7.40	0.280	0.291
P2	3.45	3.75	0.136	0.148
L	19.00	21.00	0.748	0.827
L1	4.20	4.50	0.165	0.177
b	1.00	1.40	0.039	0.055
b1	1.80	2.25	0.071	0.089
e	10.65	10.95	0.419	0.431
D	20.95	21.35	0.825	0.841
Y1	7.60	8.10	0.299	0.319
Y2	11.00	13.00	0.433	0.512
Y3	1.75	2.25	0.069	0.089
Y4	16.00	16.40	0.630	0.646
E2	4.60	4.90	0.181	0.193
T	1.35REF		0.053REF	
H	16.25REF		0.640REF	
E1	14.00REF		0.551REF	
B	6.55REF		0.258REF	