

## DO-15 Plastic-Encapsulate Diodes

### P6KE SERIES Transient Voltage Suppressor Diodes

#### Features

- P<sub>PP</sub> 600W
- V<sub>BR</sub> 6.8V-550V
- Glass passivated chip

#### Applications

- Clamping Voltage

#### Marking

- P6KEXX(A/C/CA)
- XX : From 6.8 To 550

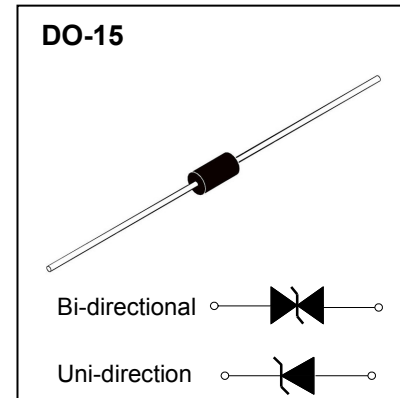

#### Limiting Values (Absolute Maximum Rating)

Item	Symbol	Unit	Conditions	Max
Peak power dissipation	PPPM	W	with a 10/1000us waveform	600
Peak pulse current	IPPM	A	with a 10/1000us waveform	See Next Table
Power dissipation	PD	W	on infinite heat sink at TL=75°C	5
Peak forward surge current	IFSM	A	8.3 ms single half sine-wave unidirectional only	100
Operation Junction and Storage Temperature Range	T <sub>J</sub> ,T <sub>STG</sub>	°C		-55 ~ +150

#### Electrical Characteristics (T=25°C Unless otherwise specified)

Item	Symbol	Unit	Conditions	Max
Maximum instantaneous forward Voltage (1)	V <sub>F</sub>	V	at 25A for unidirectional only	3.5/5.0
Thermal resistance	R <sub>θJL</sub>	°C/W	junction to lead	20
	R <sub>θJA</sub>	°C/W	junction to ambient, L <sub>Lead</sub> = 10 mm	75

#### Notes:

- (1) V<sub>F</sub> = 3.5 V for P6KE220(A) and below; V<sub>F</sub> = 5.0 V for P6KE250(A) and above

## Electrical Characteristics ( $T_A=25^\circ\text{C}$ unless otherwise noted)

Part Number(U ni)	Part Number(Bi)	Breakdown Voltage $V_{BR}@I_T$			Maximum Reverse Leakage $I_R @ V_{WM} (\mu A)$	Working Peak Reverse Voltage $V_{RWM} (V)$	Maximum Reverse Surge Current IPP (A)	Maximum Clamping Voltage $V_C @ I_{PP} (V)$	Maximum Temperature Coefficient of $V_{BR} (\%/^\circ\text{C})$
		Min(V)	Max (V)	IT(mA)					
P6KE6.8	P6KE6.8C	6.12	7.48	10	1000	5.50	55.6	10.8	0.057
P6KE6.8A	P6KE6.8CA	6.45	7.14	10	1000	5.80	57.1	10.5	0.057
P6KE7.5	P6KE7.5C	6.75	8.25	10	500	6.05	51.3	11.7	0.061
P6KE7.5A	P6KE7.5CA	7.13	7.88	10	500	6.40	53.1	11.3	0.061
P6KE8.2	P6KE8.2C	7.38	9.02	10	200	6.63	48.0	12.5	0.065
P6KE8.2A	P6KE8.2CA	7.79	8.61	10	200	7.02	49.6	12.1	0.065
P6KE9.1	P6KE9.1C	8.19	10.0	1.0	50	7.37	43.5	13.8	0.068
P6KE9.1A	P6KE9.1CA	8.65	9.55	1.0	50	7.78	44.8	13.4	0.068
P6KE10	P6KE10C	9.00	11.0	1.0	10	8.10	40.0	15.0	0.073
P6KE10A	P6KE10CA	9.50	10.5	1.0	10	8.55	41.4	14.5	0.073
P6KE11	P6KE11C	9.90	12.1	1.0	5.0	8.92	37.0	16.2	0.075
P6KE11A	P6KE11CA	10.5	11.6	1.0	5.0	9.40	38.5	15.6	0.075
P6KE12	P6KE12C	10.8	13.2	1.0	5.0	9.72	34.7	17.3	0.078
P6KE12A	P6KE12CA	11.4	12.6	1.0	5.0	10.2	35.9	16.7	0.078
P6KE13	P6KE13C	11.7	14.3	1.0	5.0	10.5	31.6	19.0	0.081
P6KE13A	P6KE13CA	12.4	13.7	1.0	5.0	11.1	33.0	18.2	0.081
P6KE15	P6KE15C	13.5	16.5	1.0	1.0	12.1	27.3	22.0	0.084
P6KE15A	P6KE15CA	14.3	15.8	1.0	1.0	12.8	28.3	21.2	0.084
P6KE16	P6KE16C	14.4	17.6	1.0	1.0	12.9	25.5	23.5	0.086
P6KE16A	P6KE16CA	15.2	16.8	1.0	1.0	13.6	26.7	22.5	0.086
P6KE18	P6KE18C	16.2	19.8	1.0	1.0	14.5	22.6	26.5	0.088
P6KE18A	P6KE18CA	17.1	18.9	1.0	1.0	15.3	23.8	25.2	0.088
P6KE20	P6KE20C	18.0	22.0	1.0	1.0	16.2	20.6	29.1	0.090
P6KE20A	P6KE20CA	19.0	21.0	1.0	1.0	17.1	21.7	27.7	0.090
P6KE22	P6KE22C	19.8	24.2	1.0	1.0	17.8	18.8	31.9	0.092
P6KE22A	P6KE22CA	20.9	23.1	1.0	1.0	18.8	19.6	30.6	0.092
P6KE24	P6KE24C	21.6	26.4	1.0	1.0	19.4	17.3	34.7	0.094
P6KE24A	P6KE24CA	22.8	25.2	1.0	1.0	20.5	18.1	33.2	0.094
P6KE27	P6KE27C	24.3	29.7	1.0	1.0	21.8	15.3	39.1	0.096
P6KE27A	P6KE27CA	25.7	28.4	1.0	1.0	23.1	16.0	37.5	0.096
P6KE30	P6KE30C	27.0	33.0	1.0	1.0	24.3	13.8	43.5	0.097
P6KE30A	P6KE30CA	28.5	31.5	1.0	1.0	25.6	14.5	41.4	0.097
P6KE33	P6KE33C	29.7	36.3	1.0	1.0	26.8	12.6	47.7	0.098
P6KE33A	P6KE33CA	31.4	34.7	1.0	1.0	28.2	13.1	45.7	0.098
P6KE36	P6KE36C	32.4	39.6	1.0	1.0	29.1	11.5	52.0	0.099
P6KE36A	P6KE36CA	34.2	37.8	1.0	1.0	30.8	12.0	49.9	0.099

## Electrical Characteristics ( $T_A=25^\circ\text{C}$ unless otherwise noted)

Part Number(Uni)	(双向) Part Number(Bi)	Breakdown Voltage $V_{BR}@I_T$			Maximum Reverse Leakage $I_R@V_{WM}$ ( $\mu\text{A}$ )	Working Peak Reverse Voltage $V_{RWM}$ (V)	Maximum Reverse Surge Current IPP (A)	Maximum Clamping Voltage $V_c@I_{PP}$ (V)	Maximum Temperature Coefficient of $V_{BR}$ ( $\%/^\circ\text{C}$ )
		Min(V)	Max (V)	$I_T$ (mA)					
P6KE39	P6KE39C	35.1	42.9	1.0	1.0	31.6	10.6	56.4	0.100
P6KE39A	P6KE39CA	37.1	41.0	1.0	1.0	33.3	11.1	53.9	0.100
P6KE43	P6KE43C	38.7	47.3	1.0	1.0	34.8	9.7	61.9	0.101
P6KE43A	P6KE43CA	40.9	45.2	1.0	1.0	36.8	10.1	59.3	0.101
P6KE47	P6KE47C	42.3	51.7	1.0	1.0	38.1	8.8	67.8	0.101
P6KE47A	P6KE47CA	44.7	49.4	1.0	1.0	40.2	9.3	64.8	0.101
P6KE51	P6KE51C	45.9	56.1	1.0	1.0	41.3	8.2	73.5	0.102
P6KE51A	P6KE51CA	48.5	53.6	1.0	1.0	43.6	8.6	70.1	0.102
P6KE56	P6KE56C	50.4	61.6	1.0	1.0	45.4	7.5	80.5	0.103
P6KE56A	P6KE56CA	53.2	58.8	1.0	1.0	47.8	7.8	77.0	0.103
P6KE62	P6KE62C	55.8	68.2	1.0	1.0	50.2	6.7	89.0	0.104
P6KE62A	P6KE62CA	58.9	65.1	1.0	1.0	53.0	7.1	85.0	0.104
P6KE68	P6KE68C	61.2	74.8	1.0	1.0	55.1	6.1	98.0	0.104
P6KE68A	P6KE68CA	64.6	71.4	1.0	1.0	58.1	6.5	92.0	0.104
P6KE75	P6KE75C	67.5	82.5	1.0	1.0	60.7	5.6	108	0.105
P6KE75A	P6KE75CA	71.3	78.8	1.0	1.0	64.1	5.8	103	0.105
P6KE82	P6KE82C	73.8	90.2	1.0	1.0	66.4	5.1	118	0.105
P6KE82A	P6KE82CA	77.9	86.1	1.0	1.0	70.1	5.3	113	0.105
P6KE91	P6KE91C	81.9	100	1.0	1.0	73.7	4.6	131	0.106
P6KE91A	P6KE91CA	86.5	95.5	1.0	1.0	77.8	4.8	125	0.106
P6KE100	P6KE100C	90.0	110	1.0	1.0	81.0	4.2	144	0.106
P6KE100A	P6KE100CA	95.0	105	1.0	1.0	85.5	4.4	137	0.106
P6KE110	P6KE110C	99.0	121	1.0	1.0	89.2	3.8	158	0.107
P6KE110A	P6KE110CA	105	116	1.0	1.0	94.0	3.9	152	0.107
P6KE120	P6KE120C	108	132	1.0	1.0	97.2	3.5	173	0.107
P6KE120A	P6KE120CA	114	126	1.0	1.0	102	3.6	165	0.107
P6KE130	P6KE130C	117	143	1.0	1.0	105	3.2	187	0.107
P6KE130A	P6KE130CA	124	137	1.0	1.0	111	3.4	179	0.107
P6KE150	P6KE150C	135	165	1.0	1.0	121	2.8	215	0.108
P6KE150A	P6KE150CA	143	158	1.0	1.0	128	2.9	207	0.108
P6KE160	P6KE160C	144	176	1.0	1.0	130	2.6	230	0.108
P6KE160A	P6KE160CA	152	168	1.0	1.0	136	2.7	219	0.108
P6KE170	P6KE170C	153	187	1.0	1.0	138	2.5	244	0.108
P6KE170A	P6KE170CA	162	179	1.0	1.0	145	2.6	234	0.108
P6KE180	P6KE180C	162	198	1.0	1.0	146	2.3	258	0.108
P6KE180A	P6KE180CA	171	189	1.0	1.0	154	2.4	246	0.108

## Electrical Characteristics ( $T_A=25^{\circ}\text{C}$ unless otherwise noted)

Part Number(Uni)	Part Number(Bi)	Breakdown Voltage $V_{BR}@I_T$			Maximum Reverse Leakage $I_R @ V_{WM} (\mu A)$	Working Peak Reverse Voltage $V_{RWM} (V)$	Maximum Reverse Surge Current IPP (A)	Maximum Clamping Voltage $V_c @ I_{PP} (V)$	Maximum Temperature Coefficient of $V_{BR} (\%/^{\circ}\text{C})$
		Min(V)	Max (V)	$I_T(\text{mA})$					
P6KE200	P6KE200C	180	220	1.0	1.0	162	2.1	287	0.108
P6KE200A	P6KE200CA	190	210	1.0	1.0	171	2.2	274	0.108
P6KE220	P6KE220C	198	242	1.0	1.0	175	1.7	344	0.108
P6KE220A	P6KE220CA	209	231	1.0	1.0	185	1.8	328	0.108
P6KE250	P6KE250C	225	275	1.0	1.0	202	1.7	360	0.110
P6KE250A	P6KE250CA	237	263	1.0	1.0	214	1.7	344	0.110
P6KE300	P6KE300C	270	330	1.0	1.0	243	1.4	430	0.110
P6KE300A	P6KE300CA	285	315	1.0	1.0	256	1.4	414	0.110
P6KE350	P6KE350C	315	385	1.0	1.0	284	1.2	504	0.110
P6KE350A	P6KE350CA	333	368	1.0	1.0	300	1.2	482	0.110
P6KE400	P6KE400C	360	440	1.0	1.0	324	1.0	574	0.110
P6KE400A	P6KE400CA	380	420	1.0	1.0	342	1.1	548	0.110
P6KE440	P6KE440C	396	484	1.0	1.0	356	0.95	631	0.110
P6KE440A	P6KE440CA	418	462	1.0	1.0	376	1.00	602	0.110
P6KE480	P6KE480C	432	528	1.0	1.0	389	0.88	686	0.110
P6KE480A	P6KE480CA	456	504	1.0	1.0	408	0.91	658	0.110
P6KE510	P6KE510C	459	561	1.0	1.0	413	0.82	729	0.110
P6KE510A	P6KE510CA	485	535	1.0	1.0	434	0.86	698	0.110
P6KE540	P6KE540C	486	594	1.0	1.0	437	0.78	772	0.110
P6KE540A	P6KE540CA	513	567	1.0	1.0	459	0.81	740	0.110
P6KE550	P6KE550C	495	605	1.0	1.0	470	0.76	786	0.110
P6KE550A	P6KE550CA	522.5	577.5	1.0	1.0	467	0.79	760	0.110
P6KE600	P6KE600C	560	660	1.0	1.0	480	0.94	690	0.110
P6KE600A	P6KE600CA	570	630	1.0	1.0	510	1.00	822	0.110

# Typical Characteristics

**FIG1: Peak Pulse Power Rating Curve**

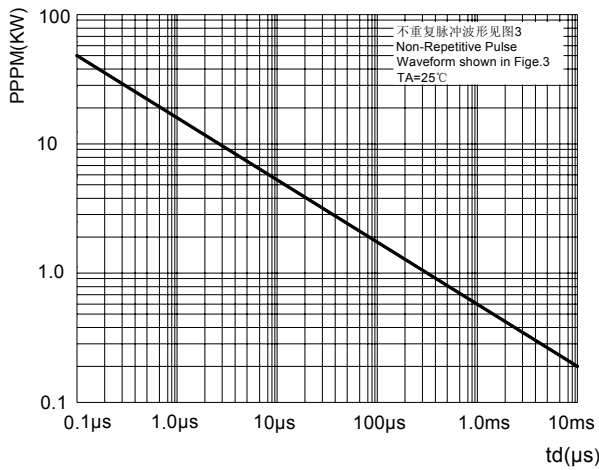

**FIG2: Pulse Power or Current vs. Initial Junction Temperature**

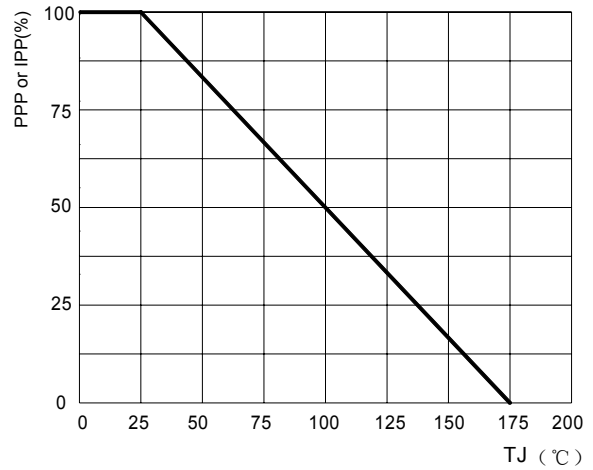

**FIG3: Pulse Waveform**

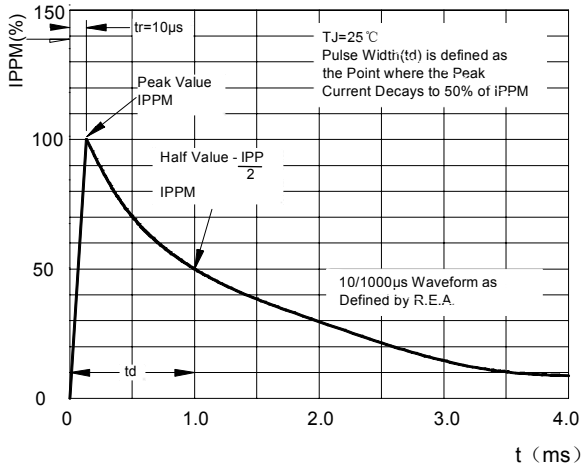

**FIG4: Power Derating Curve**

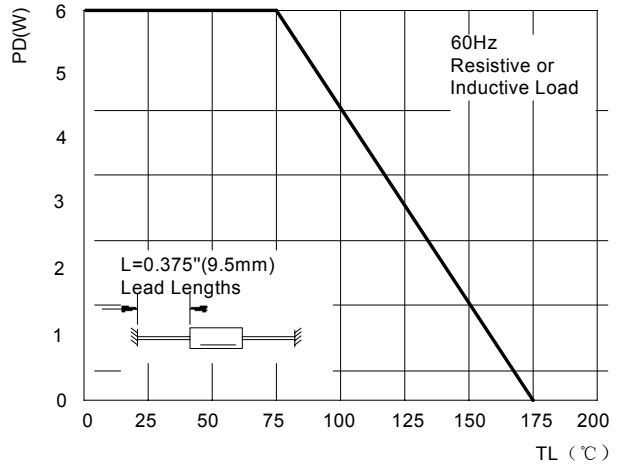

**FIG5: Maximum Non-Repetitive Surge Current**

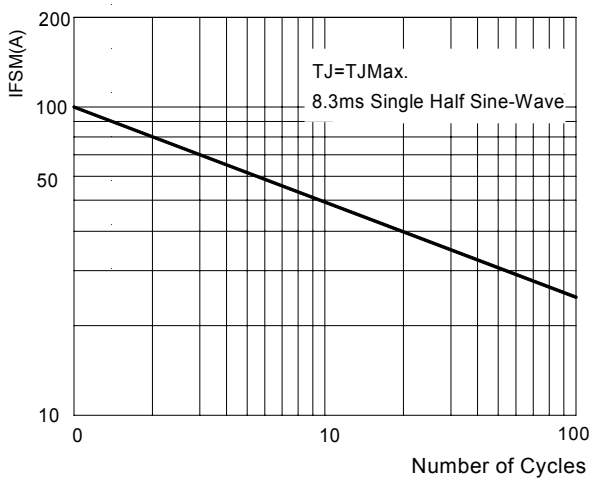

**FIG6: Typical Transient Thermal Impedance**

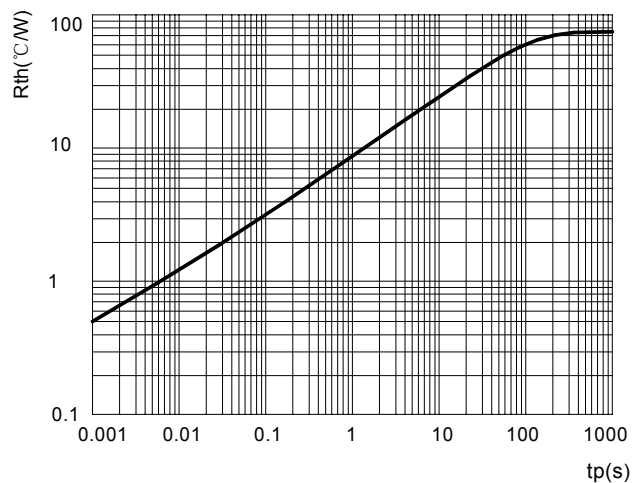

## DO-15 Package Outline Dimensions

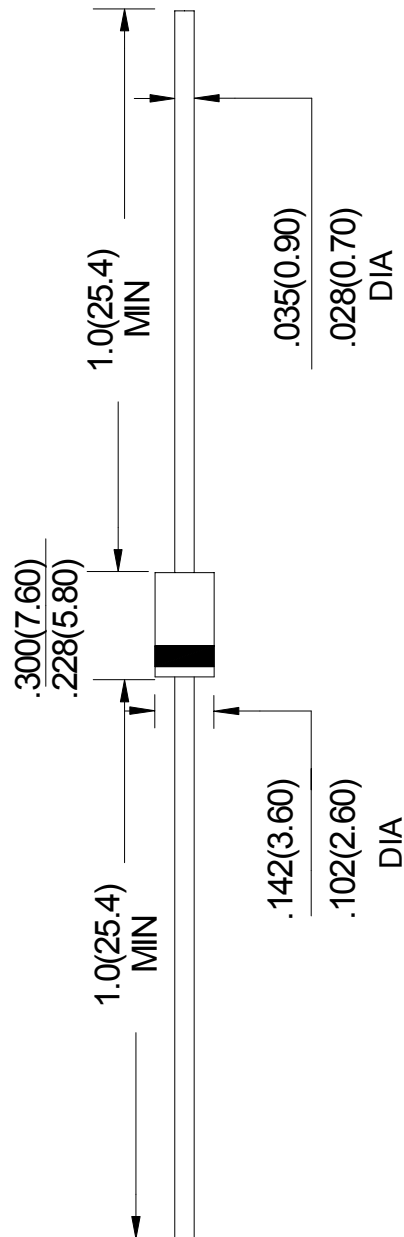

Unit: in inches (millimeters)

### NOTICE

JSCJ reserves the right to make modifications, enhancements, improvements, corrections or other changes without further notice to any product herein. JSCJ does not assume any liability arising out of the application or use of any product described herein.

# Ammo Box Packaging Specifications For Axial Lead Rectifiers

Axial lead devices are packed in accordance with EIA standard RS-296-D and specifications given below

COMPONENT OUTLINE	COMPONENT PITCH A	INNER TAPE PITCH B	CUMULATIVE PITCH TOLERANCE
	$\pm 0.5\text{mm}(.020'')$	$+0.5\text{mm}(.020'')$	
R-1	5.0mm	26.0mm	2.0mm/20pitch
R-1	5.0mm	52.4mm	2.0mm/10pitch
A-405	5.0mm	26.0mm	2.0mm/20pitch
A-405	5.0mm	52.4mm	2.0mm/10pitch
DO-34/DO-35	5.0mm	26.0mm	2.0mm/20pitch
DO-34/DO-35	5.0mm	52.4mm	2.0mm/10pitch
DO-41	5.0mm	26.0mm	2.0mm/20pitch
DO-41	5.0mm	52.4mm	2.0mm/10pitch
DO-15	5.0mm	52.4mm	2.0mm/10pitch
DO-27	10.0mm	52.4mm	2.0mm/10pitch
R-6	10.0mm	52.4mm	2.0mm/10pitch

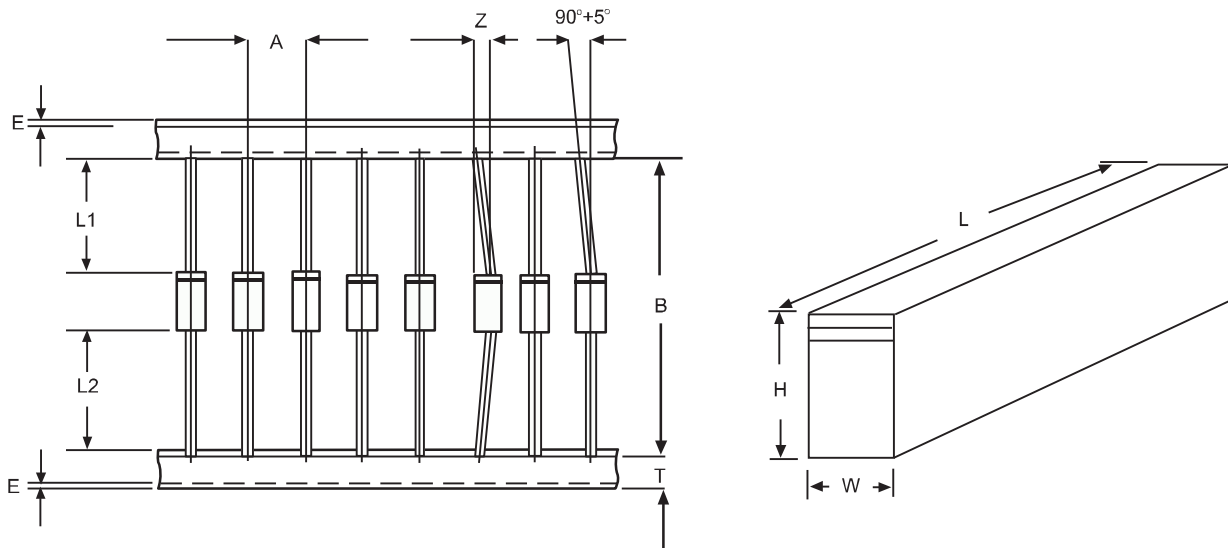

ITEM	SYMBOL	SPECIFICATIONS(mm)	SPECIFICATIONS(inch)
Component alignment	Z	1.2max	0.048max
Tape width	T	$6.0\pm 0.4$	$0.236\pm 0.016$
Exposed adhesive	E	0.8max	0.032max
Body eccentricity	$ L1-L2 $	1.0max	0.040max
Box length	L	$255.0\pm 5.0$	$10.04\pm 0.197$
Box width	W	$78.0\pm 5.0$	$3.07\pm 0.197$
Box height	H	$150.0\pm 5.0$	$5.91\pm 0.197$

NOTE: Each component lead shall be sandwiched between tapes for A minimum of 3.2mm(0.126'')