

## SOT-363 Plastic-Encapsulate Diodes

### RB551XN-30 Schottky Barrier Diode

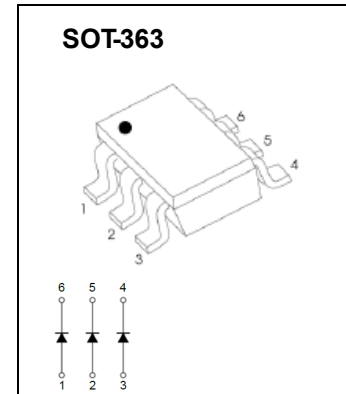

#### FEATURES

- Low current rectifier schottky diode
- Low voltage, low inductance
- For power supply

#### MAKING:

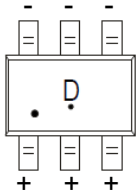

Solid dot = Pin1 indicator  
Solid dot = Green molding compound device.

#### Maximum Ratings and Electrical Characteristics, Single Diode @Ta=25°C

Parameter S	ymbol	Limit	Unit
Peak reverse voltage	$V_{RM}$	30	V
DC reverse voltage	$V_R$	30	V
Mean rectifying current	$I_O$	0.5	A
Non-repetitive Peak Forward Surge Current@t=8.3ms	$I_{FSM}$	2	A
Power dissipation	$P_d$	200	mW
Thermal resistance junction to ambient	$R_{\theta JA}$	500	°C/W
Operating Junction Temperature Range	$T_j$	-40 ~ +125	°C
Storage Temperature Range	$T_{stg}$	-55 ~ +150	°C

#### Electrical Ratings @Ta=25°C

Parameter	Symbol	Min	Typ	Max	Unit	Conditions
Forward voltage	$V_F$			0.36 0.47	V	$I_F=100mA$ $I_F=500mA$
Reverse current	$I_R$			100	μA	$V_R=20V$

# Typical Characteristics

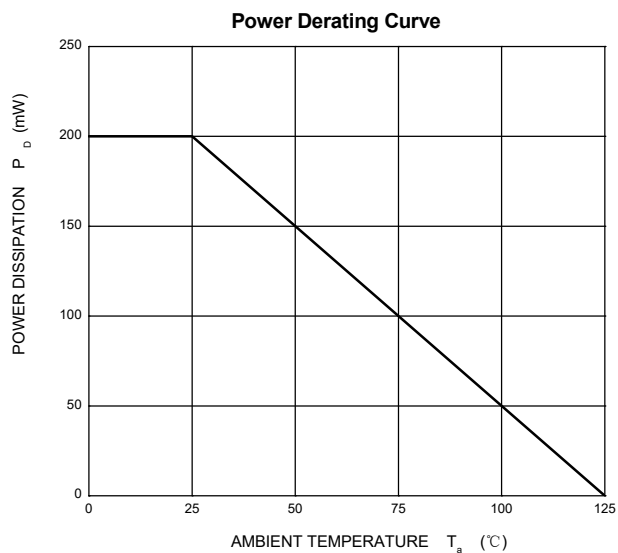
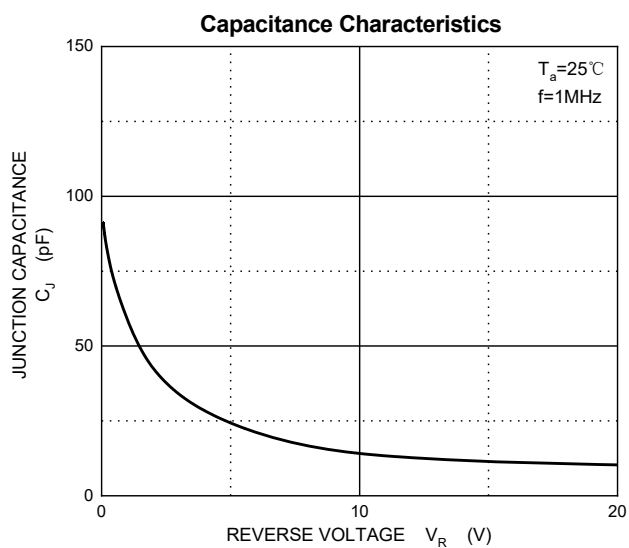
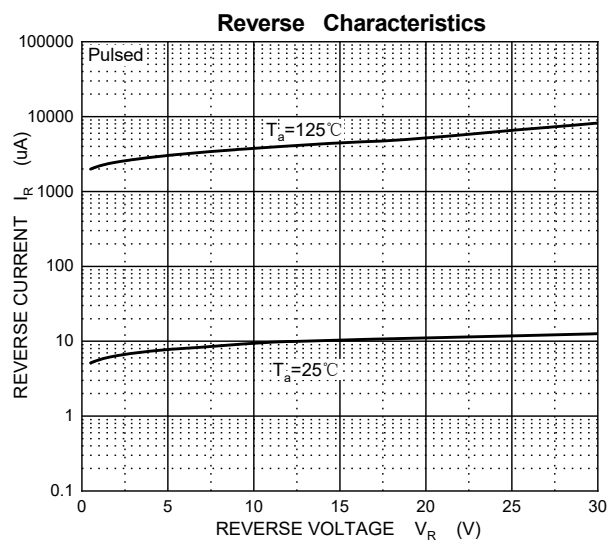
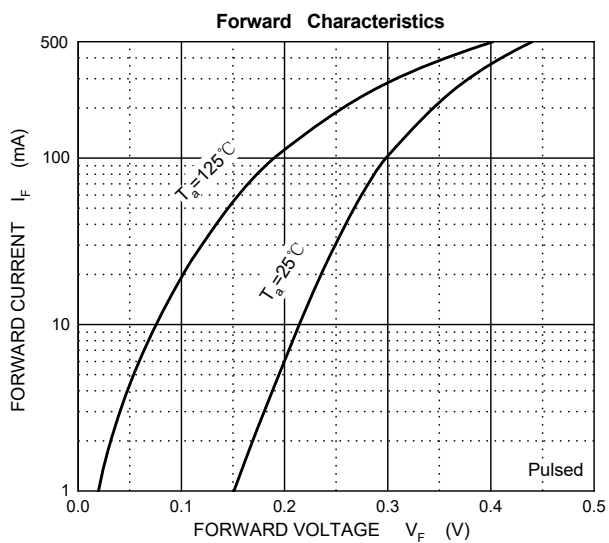

## SOT-363 Package Outline Dimensions

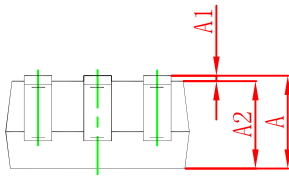
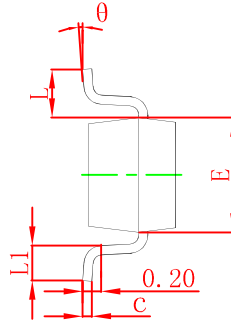
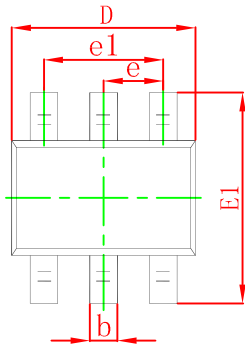

Symbol	Dimensions In Millimeters		Dimensions In Inches	
	Min	Max	Min	Max
A	0.900	1.100	0.035	0.043
A1	0.000	0.100	0.000	0.004
A2	0.900	1.000	0.035	0.039
b	0.150	0.350	0.006	0.014
c	0.100	0.150	0.004	0.006
D	2.000	2.200	0.079	0.087
E	1.150	1.350	0.045	0.053
E1	2.150	2.400	0.085	0.094
e	0.650 TYP		0.026 TYP	
e1	1.200	1.400	0.047	0.055
L	0.525 REF		0.021 REF	
L1	0.260	0.460	0.010	0.018
$\theta$	0°	8°	0°	8°

## SOT-363 Suggested Pad Layout

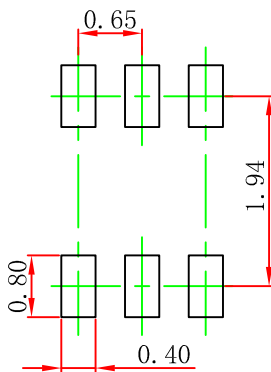

Note:

1. Controlling dimension: in millimeters.
2. General tolerance:  $\pm 0.05$  mm.
3. The pad layout is for reference purposes only.

### NOTICE

JSCJ reserves the right to make modifications, enhancements, improvements, corrections or other changes without further notice to any product herein. JSCJ does not assume any liability arising out of the application or use of any product described herein.

# SOT-363 Tape and Reel

## SOT-363 Embossed Carrier Tape

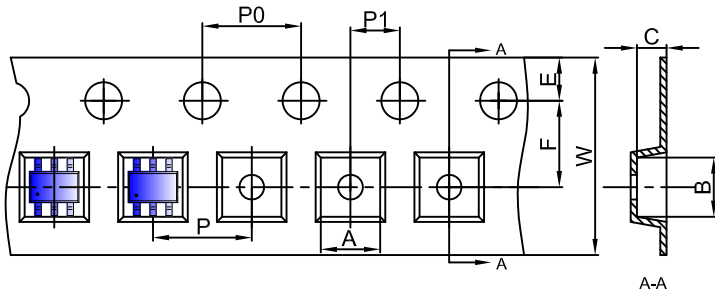

### Packaging Description:

SOT-363 parts are shipped in tape. The carrier tape is made from a dissipative (carbon filled) polycarbonate resin. The cover tape is a multilayer film (Heat Activated Adhesive in nature) primarily composed of polyester film, adhesive layer, sealant, and anti-static sprayed agent. These reeled parts in standard option are shipped with 3,000 units per 7" or 17.8cm diameter reel. The reels are clear in color and is made of polystyrene plastic (anti-static coated).

Dimensions are in millimeter										
Pkg type	A	B	C	d	E	F	P0	P	P1	W
SOT-363	2.25	2.55	1.20	Ø1.50	1.75	3.50	4.00	4.00	2.00	8.00

## SOT-363 Tape Leader and Trailer

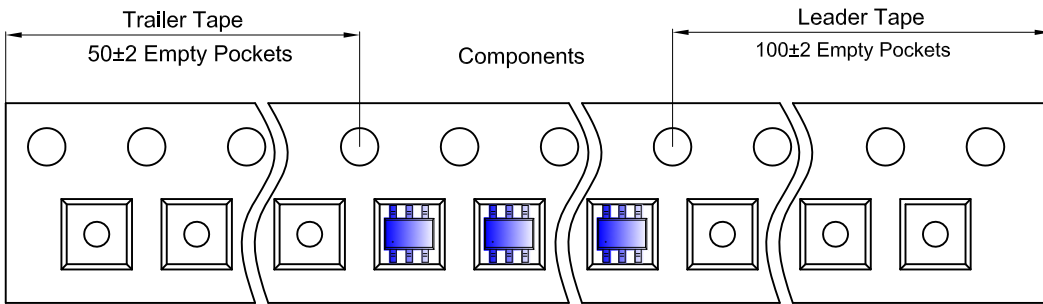

## SOT-363 Reel

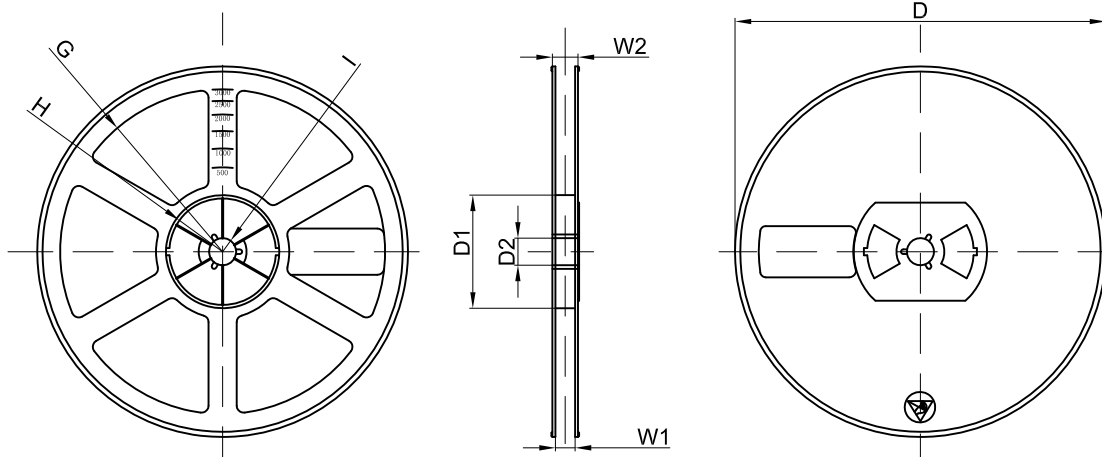

Dimensions are in millimeter								
Reel Option	D	D1	D2	G	H	I	W1	W2
7"Dia	Ø178.00	54.40	13.00	R78.00	R25.60	R6.50	9.50	12.30

REEL	Reel Size	Box	Box Size(mm)	Carton	Carton Size(mm)	G.W.(kg)
3000 pcs	7 inch	45,000 pcs	203×203×195	180,000 pcs	438×438×220	