

# TO-220-3L/TO-220F-B Plastic-Encapsulate Diode

## SBD40100TCTBZ、SBDF40100TCTBZ SCHOTTKY BARRIER RECTIFIER

### MAIN CHARACTERISTICS

$I_o$	<b>40 (2×20) A</b>
$V_{RRM}$	<b>100 V</b>
$T_j$	<b>150 °C</b>
$V_{F(typ)}$	<b>0.68V (@T<sub>j</sub>=125°C)</b>

### FEATURES

- Low Power Loss, High Efficiency
- Guard Ring Die Construction for Transient Protection
- High Current Capability and Low Forward Voltage Drop

### MARKING

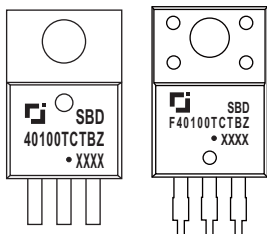

SBD(F)40100TCTBZ = Device code  
 Solid dot = Green molding compound device  
 if none, the normal device  
 XXXX = Code

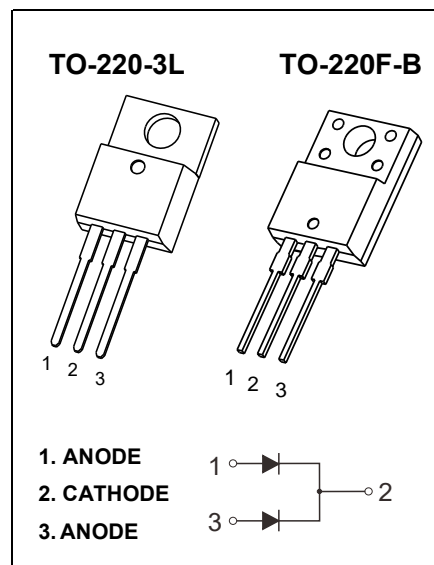

### MAXIMUM RATINGS ( T<sub>a</sub>=25°C unless otherwise noted )

Symbol	Parameter	SBD		Unit
		40100TCTBZ	F40100TCTBZ	
$V_{RRM}$	Peak repetitive reverse voltage	100		V
$V_{RWM}$	Working peak reverse voltage			
$V_R$	DC blocking voltage			
$V_{R(RMS)}$	RMS reverse voltage	70		V
$I_o$	Average rectified output current	40		A
$I_{FSM}$	Non-Repetitive peak forward surge current (8.3ms half sine wave)	250		A
$R_{\theta Jc}$	Thermal resistance from junction to case , T <sub>c</sub> =25°C	2.0	3.0	°C/W
$R_{\theta JA}$	Thermal resistance from junction to ambient	62.5		°C/W
$T_j$	Junction temperature	150		°C
$T_{stg}$	Storage temperature	-55~+150		°C

### ELECTRICAL CHARACTERISTICS ( T<sub>a</sub>=25°C unless otherwise specified )

Parameter	Symbol	Test conditions	Min	Typ	Max	Unit
Reverse voltage	$V_{(BR)}$	$I_R=0.1mA$	100			V
Reverse current	$I_R$	$V_R=100V$	$T_j = 25^\circ C$	10	100	uA
			$T_j = 125^\circ C$	10		mA
Forward voltage	$V_F$	$I_F=15A$	$T_j = 25^\circ C$	0.65		V
			$T_j = 125^\circ C$	0.62		V
		$I_F=20A$	$T_j = 25^\circ C$	0.73	0.80	V
			$T_j = 125^\circ C$	0.68		V

\*Pulse test: pulse width ≤300μs, duty cycles ≤ 2.0%.

# Typical Characteristics

**Forward Current Derating Curve**

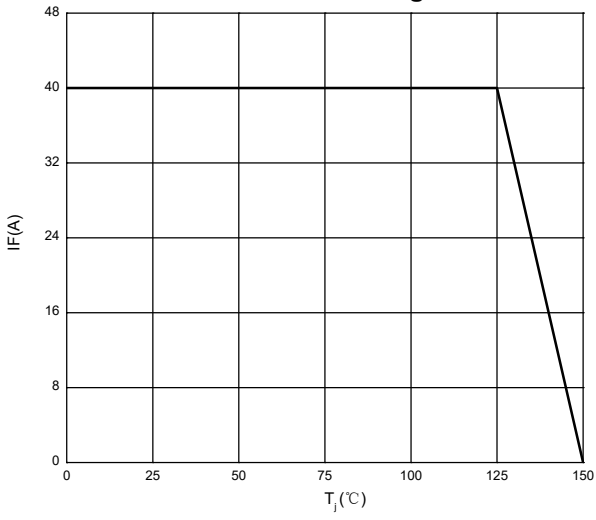

**Forward Characteristics**

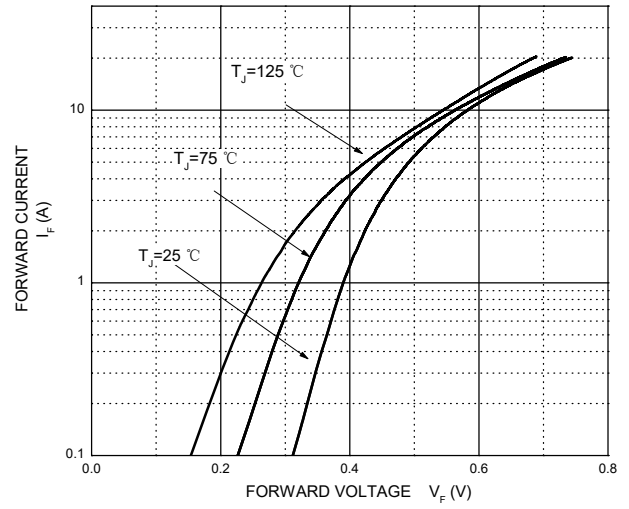

**Reverse Characteristics**

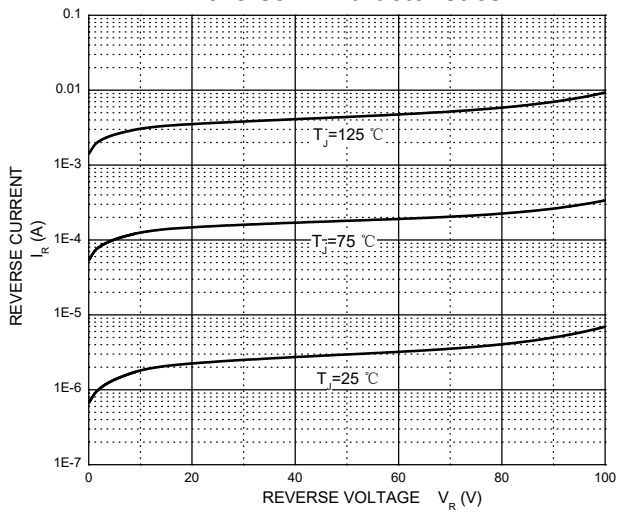

**Capacitance Characteristics Per Diode**

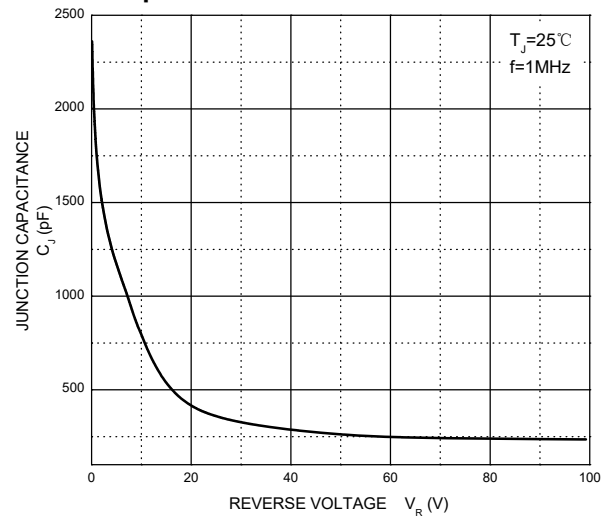

# TO-220-3L Package Outline Dimensions



Symbol	Dimensions In Millimeters		Dimensions In Inches	
	Min	Max	Min	Max
A	4.450	4.750	0.175	0.187
A1	2.520	2.820	0.099	0.111
b	0.710	0.910	0.028	0.036
b1	1.170	1.370	0.046	0.054
c	0.300	0.500	0.012	0.020
c1	1.170	1.370	0.046	0.054
D	9.830	10.330	0.387	0.407
E	8.500	8.900	0.335	0.350
E1	12.050	12.650	0.474	0.498
e	2.540 TYP		0.100 TYP	
e1	4.900	5.200	0.192	0.205
F	2.540	2.940	0.100	0.116
h	0.100 TYP		0.004 TYP	
L	13.300	13.800	0.523	0.543
L1	3.540	3.940	0.139	0.155
Φ	3.735	3.935	0.147	0.155

# TO-220F-B Package Outline Dimensions

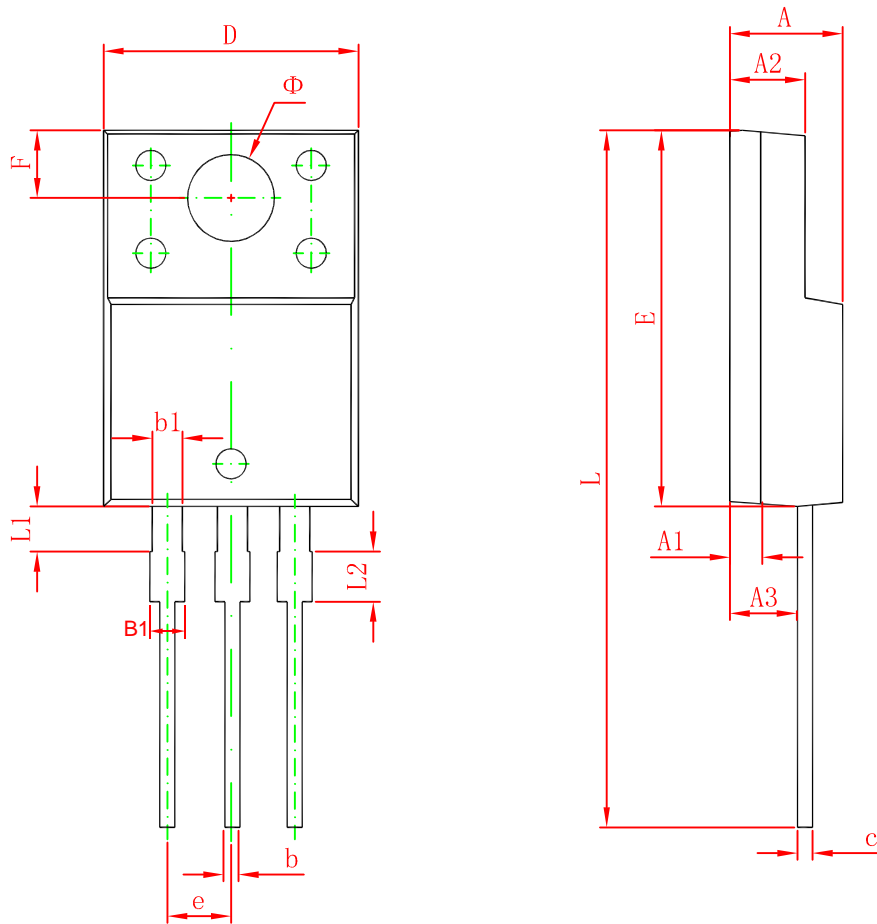

Symbol	Dimensions In Millimeters		Dimensions In Inches	
	Min.	Max.	Min.	Max.
A	4.300	4.700	0.169	0.185
A1	1.200 REF.		0.047 REF.	
A2	2.800	3.200	0.110	0.126
A3	2.500	2.900	0.098	0.114
b	0.710	0.910	0.028	0.036
b1	1.100	1.350	0.043	0.053
B1	1.150	1.400	0.045	0.055
c	0.500	0.750	0.020	0.030
D	9.960	10.360	0.392	0.408
E	14.800	15.200	0.583	0.598
e	2.540 TYP.		0.100 TYP.	
F	2.700 REF.		0.106 REF.	
$\Phi$	3.300	3.700	0.130	0.146
L	28.000	28.400	1.102	1.118
L1	2.100	2.400	0.082	0.094
L2	1.300	1.700	0.051	0.066