



## TO-263-2L Plastic-Encapsulate Diode

### SBDB2045TCTB SCHOTTKY BARRIER RECTIFIER

#### MAIN CHARACTERISTICS

$I_o$	<b>20 (2×10) A</b>
$V_{RRM}$	<b>45 V</b>
$T_j$	<b>150 °C</b>
$V_{F(typ)}$	<b>0.38V (@Ta=125°C)</b>

#### FEATURES

- Low Power Loss, High Efficiency
- Guard Ring Die Construction for Transient Protection
- High Current Capability and Low Forward Voltage Drop

#### MARKING

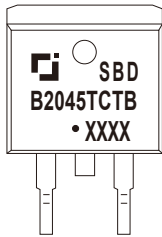

SBDB2045TCTB = Device code  
 Solid dot = Green molding compound device  
 if none, the normal device  
 XXXX = Code

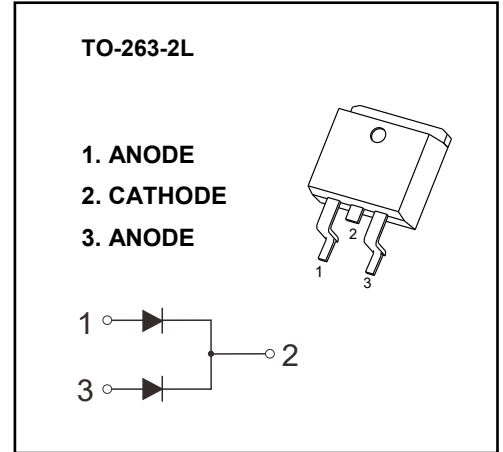

#### MAXIMUM RATINGS ( $T_a=25^\circ\text{C}$ unless otherwise noted )

Symbol	Parameter	Value	Unit
$V_{RRM}$	Peak repetitive reverse voltage	45	V
$V_{RWM}$	Working peak reverse voltage		
$V_R$	DC blocking voltage		
$V_{R(RMS)}$	RMS reverse voltage	31.5	V
$I_o$	Average rectified output current	20	A
$I_{FSM}$	Non-Repetitive peak forward surge current (8.3ms half sine wave)	200	A
$R_{\theta JC}$	Thermal resistance from junction to case , $T_c=25^\circ\text{C}$	2.0	$^\circ\text{C}/\text{W}$
$R_{\theta JA}$	Thermal resistance from junction to ambient	62.5	$^\circ\text{C}/\text{W}$
$T_j$	Junction temperature	150	$^\circ\text{C}$
$T_{stg}$	Storage temperature	-55~+150	$^\circ\text{C}$

#### ELECTRICAL CHARACTERISTICS ( $T_a=25^\circ\text{C}$ unless otherwise specified)

Parameter	Symbol	Test conditions	Min	Typ	Max	Unit
Reverse voltage	$V_{(BR)}$	$I_R=1.0\text{mA}$	45			V
Reverse current	$I_R$	$V_R=45\text{V}$	$T_j=25^\circ\text{C}$	50	100	$\mu\text{A}$
			$T_j=125^\circ\text{C}$	20		mA
Forward voltage	$V_F$	$I_F=5\text{A}$	$T_j=25^\circ\text{C}$	0.40		V
			$T_j=125^\circ\text{C}$	0.30		V
		$I_F=10\text{A}$	$T_j=25^\circ\text{C}$	0.46	0.55	V
			$T_j=125^\circ\text{C}$	0.38		V

\*Pulse test: pulse width  $\leq 300\mu\text{s}$ , duty cycles  $\leq 2.0\%$ .

# Typical Characteristics

FIG.1: FORWARD CURRENT DERATING CURVE

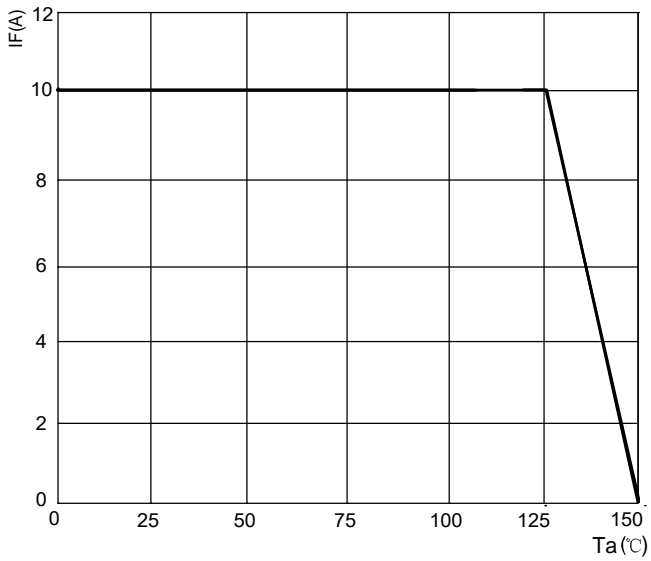

FIG.2: TYPICAL FORWARD CHARACTERISTICS

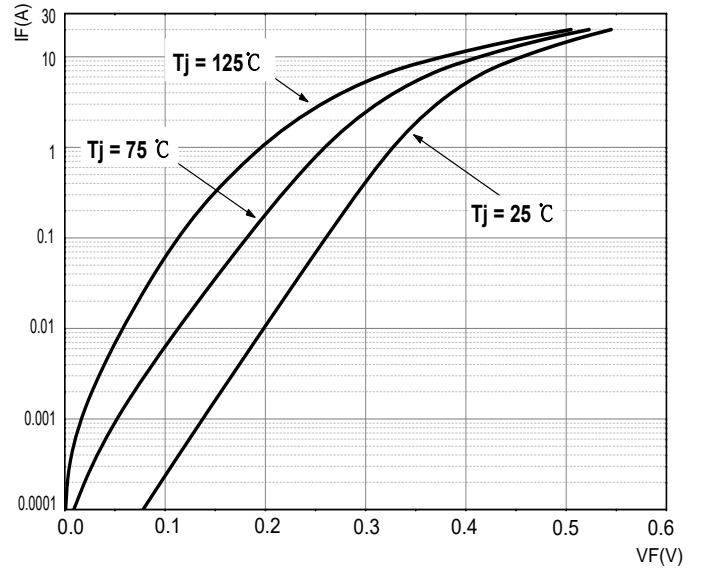

FIG.3: TOTAL CAPACITANCE DERATING CURVE

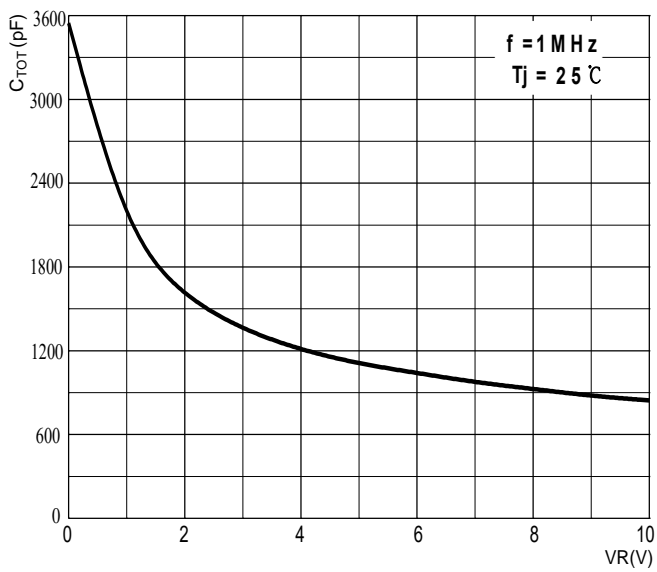
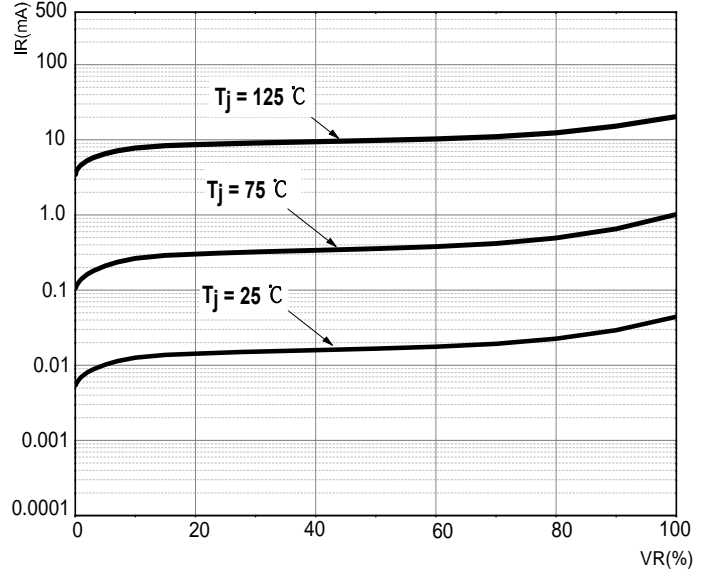
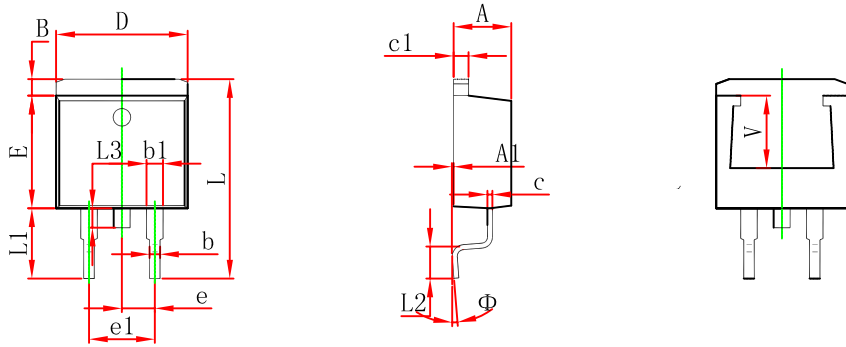

FIG.4: TYPICAL REVERSE CHARACTERISTICS



## TO-263-2L Package Outline Dimensions



Symbol	Dimensions In Millimeters		Dimensions In Inches	
	Min.	Max.	Min.	Max.
A	4.470	4.670	0.176	0.184
A1	0.000	0.150	0.000	0.006
B	1.120	1.420	0.044	0.056
b	0.710	0.910	0.028	0.036
b1	1.170	1.370	0.046	0.054
c	0.310	0.530	0.012	0.021
c1	1.170	1.370	0.046	0.054
D	10.010	10.310	0.394	0.406
E	8.500	8.900	0.335	0.350
e	2.540 TYP.		0.100 TYP.	
e1	4.980	5.180	0.196	0.204
L	14.940	15.500	0.588	0.610
L1	4.950	5.450	0.195	0.215
L2	2.340	2.740	0.092	0.108
L3	1.300	1.700	0.051	0.067
Φ	0° 8°		0° 8°	
V	5.600 REF.		0.220 REF.	

## TO-263-2L Suggested Pad Layout

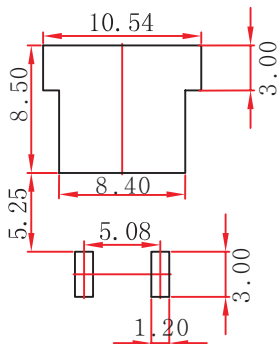

### Note:

1. Controlling dimension: in millimeters.
2. General tolerance:  $\pm 0.05$  mm.
3. The pad layout is for reference purposes only.

### NOTICE

JSCJ reserves the right to make modifications, enhancements, improvements, corrections or other changes without further notice to any product herein. JSCJ does not assume any liability arising out of the application or use of any product described herein.

# TO-263-2L Tape and Reel

## TO-263-2L Embossed Carrier Tape



### Packaging Description:

TO-263-2L parts are shipped in tape. The carrier tape is made from a dissipative (carbon filled) polycarbonate resin. The cover tape is a multilayer film (Hear Activated Adhesive in nature) primarily composed of polyester film, adhesive layer, sealant, and anti-static sprayed agent. These reeled parts in standard option are shipped with 800 units per 13" or 33.0 cm diameter reel. The reels are clear in color and is made of polystyrene plastic (anti-static coated).

Dimensions are in millimeter										
Pkg type	A	B	C	d	E	F	P0	P	P1	W
TO-263	10.80	16.13	5.21	Φ1.55	1.75	11.50	4.00	16.00	2.00	24.00

## TO-263-2L Tape Leader and Trailer



## TO-263-2L Reel

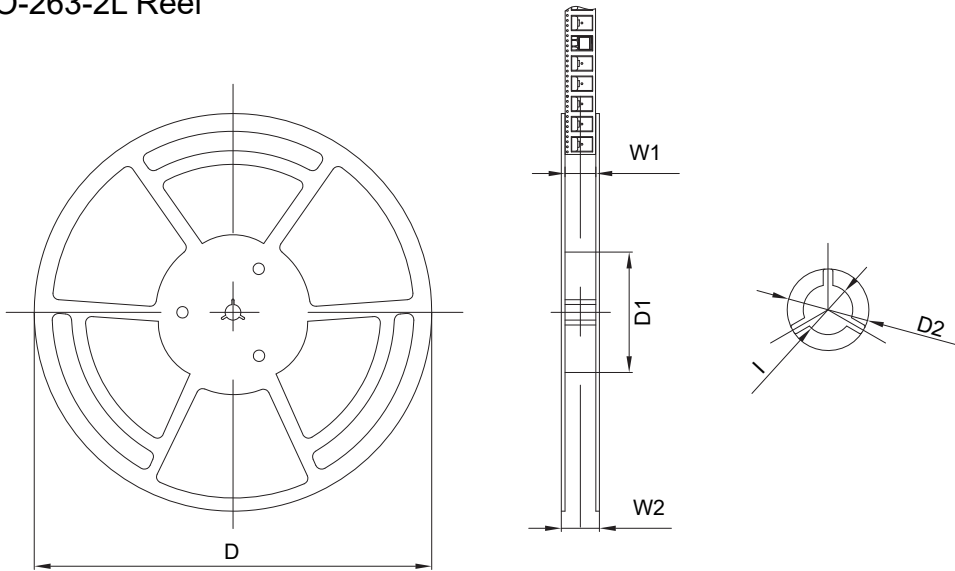

Dimensions are in millimeter						
Reel	D	D1	D2	W1	W2	I
13" Dia	330.00	100.00	Φ21.00	24.40	30.40	Φ13.00

Reel	Reel Size	Box	Box Size(mm)	Carton	Carton Size(mm)
800 pcs	13 inch	1600 pcs	360×360×65	8000 pcs	378×358×382