

TO-263-2L Plastic-Encapsulate Diode

SBDB3060SCTB SCHOTTKY BARRIER RECTIFIER

MAIN CHARACTERISTICS

I_o	30 (2×15) A
V_{RRM}	60 V
T_j	150 °C
$V_{F(typ)}$	0.42V (@$T_j=125^{\circ}C$)

FEATURES

- Low Power Loss, High Efficiency
- Guard Ring Die Construction for Transient Protection
- High Current Capability and Low Forward Voltage Drop

MARKING

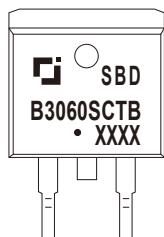

SBDB3060SCTB = Device code
 Solid dot = Green molding compound device
 if none, the normal device
 XXXX = Code

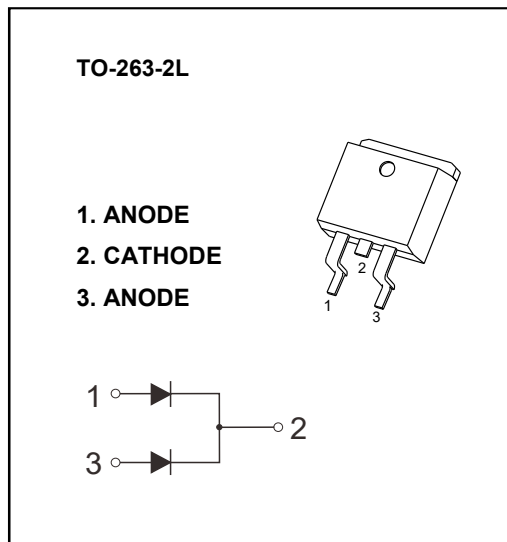

MAXIMUM RATINGS ($T_a=25^{\circ}C$ unless otherwise noted)

Symbol	Parameter	Value	Unit
V_{RRM}	Peak repetitive reverse voltage	60	V
V_{RWM}	Working peak reverse voltage		
V_R	DC blocking voltage		
$V_{R(RMS)}$	RMS reverse voltage	42	V
I_o	Average rectified output current	HO	A
I_{FSM}	Non-Repetitive peak forward surge current (8.3ms half sine wave)	270	A
$R_{\theta Jc}$	Thermal resistance from junction to case , $T_c=25^{\circ}C$	2.0	$^{\circ}C/W$
$R_{\theta JA}$	Thermal resistance from junction to ambient	62.5	$^{\circ}C/W$
T_j	Junction temperature	150	$^{\circ}C$
T_{stg}	Storage temperature	-55~+150	$^{\circ}C$

ELECTRICAL CHARACTERISTICS ($T_a=25^{\circ}C$ unless otherwise specified)

Parameter	Symbol	Test conditions	Min	Typ	Max	Unit
Reverse voltage	$V_{(BR)}$	$I_R=0.1mA$	60			V
Reverse current	I_R	$V_R=60V$	$T_j=25^{\circ}C$	60	200	μA
			$T_j=125^{\circ}C$	26		mA
Forward voltage	V_F	$I_F=F\epsilon A$	$T_j=25^{\circ}C$	0.44		V
			$T_j=125^{\circ}C$	0.36		V
		$I_F=1A$	$T_j=25^{\circ}C$	0.49	0.57	V
			$T_j=125^{\circ}C$	0.42		V

*Pulse test: pulse width $\leq 300\mu s$, duty cycles $\leq 2.0\%$.

Typical Characteristics

Forward Current Derating Curve

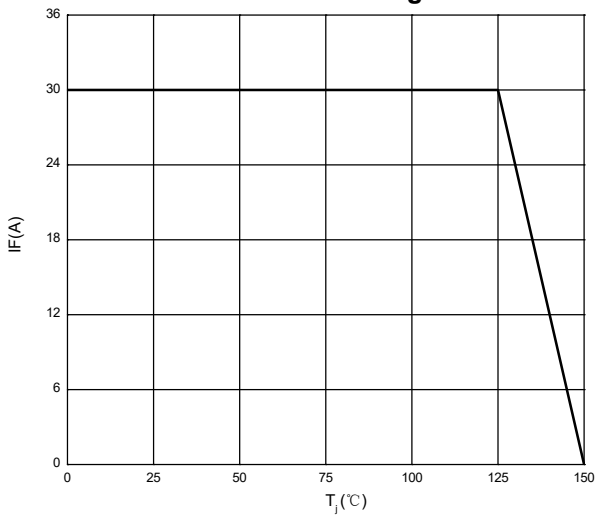

Forward Characteristics

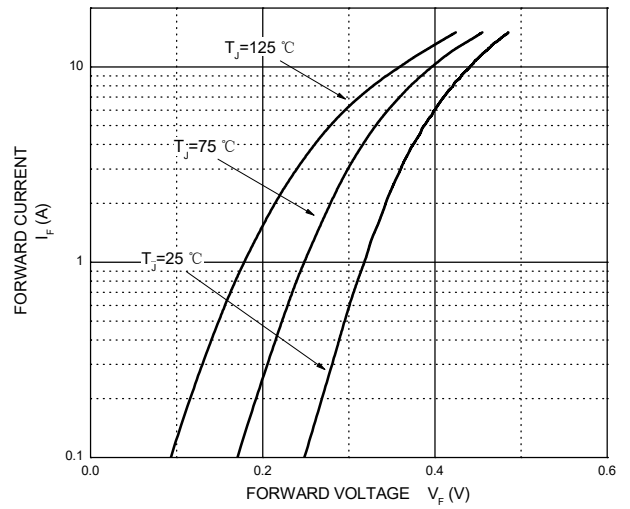

Reverse Characteristics

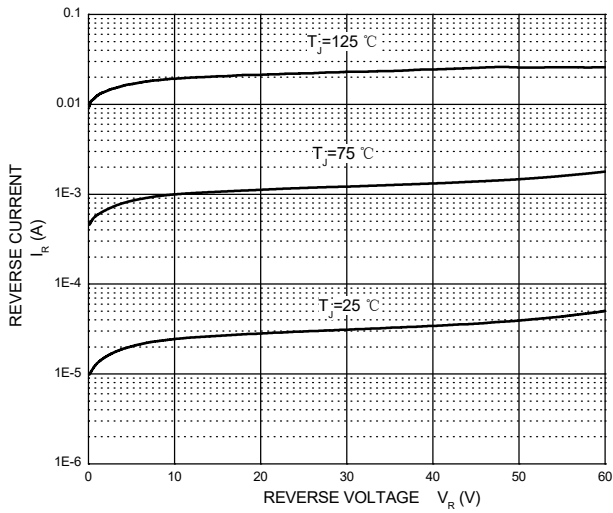

Capacitance Characteristics Per Diode

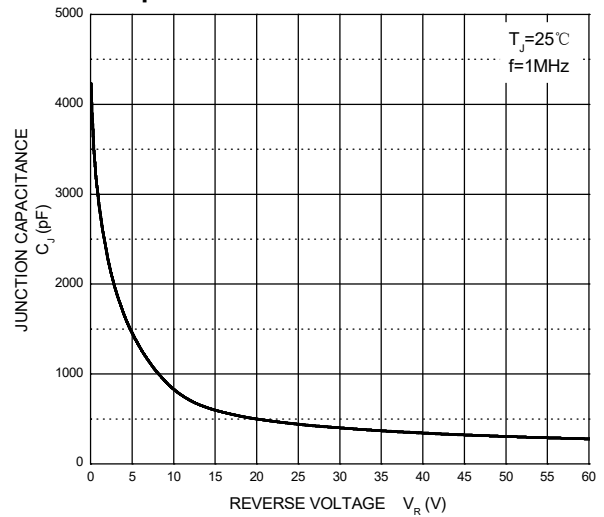

TO-263-2L Package Outline Dimensions

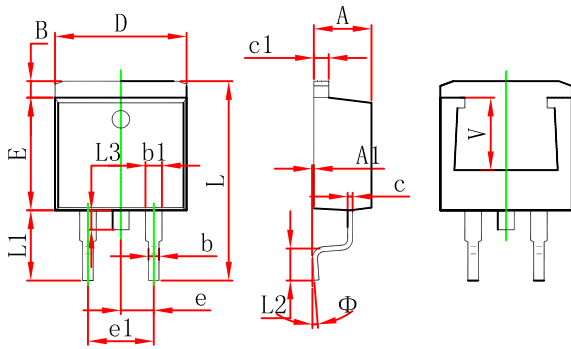

Symbol	Dimensions In Millimeters		Dimensions In Inches	
	Min.	Max.	Min.	Max.
A	4.470	4.670	0.176	0.184
A1	0.000	0.150	0.000	0.006
B	1.120	1.420	0.044	0.056
b	0.710	0.910	0.028	0.036
b1	1.170	1.370	0.046	0.054
c	0.310	0.530	0.012	0.021
c1	1.170	1.370	0.046	0.054
D	10.010	10.310	0.394	0.406
E	8.500	8.900	0.335	0.350
e	2.540 TYP.		0.100 TYP.	
e1	4.980	5.180	0.196	0.204
L	14.940	15.500	0.588	0.610
L1	4.950	5.450	0.195	0.215
L2	2.340	2.740	0.092	0.108
L3	1.300	1.700	0.051	0.067
Φ	0°	8°	0°	8°
V	5.600 REF.		0.220 REF.	

TO-263-2L Suggested Pad Layout

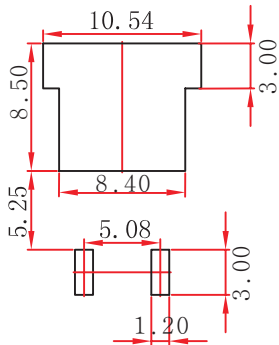

Note:

1. Controlling dimension: in millimeters.
2. General tolerance: ± 0.05 mm.
3. The pad layout is for reference purposes only.

TO-263-2L Tape and Reel

TO-263-2L Embossed Carrier Tape



Packaging Description:

TO-263-2L parts are shipped in tape. The carrier tape is made from a dissipative (carbon filled) polycarbonate resin. The cover tape is a multilayer film (Hear Activated Adhesive in nature) primarily composed of polyester film, adhesive layer, sealant, and anti-static sprayed agent. These reeled parts in standard option are shipped with 800 units per 13" or 33.0 cm diameter reel. The reels are clear in color and is made of polystyrene plastic (anti-static coated).

Dimensions are in millimeter										
Pkg type	A	B	C	d	E	F	P0	P	P1	W
TO-263	10.80	16.13	5.21	Φ1.55	1.75	11.50	4.00	16.00	2.00	24.00

TO-263-2L Tape Leader and Trailer



TO-263-2L Reel

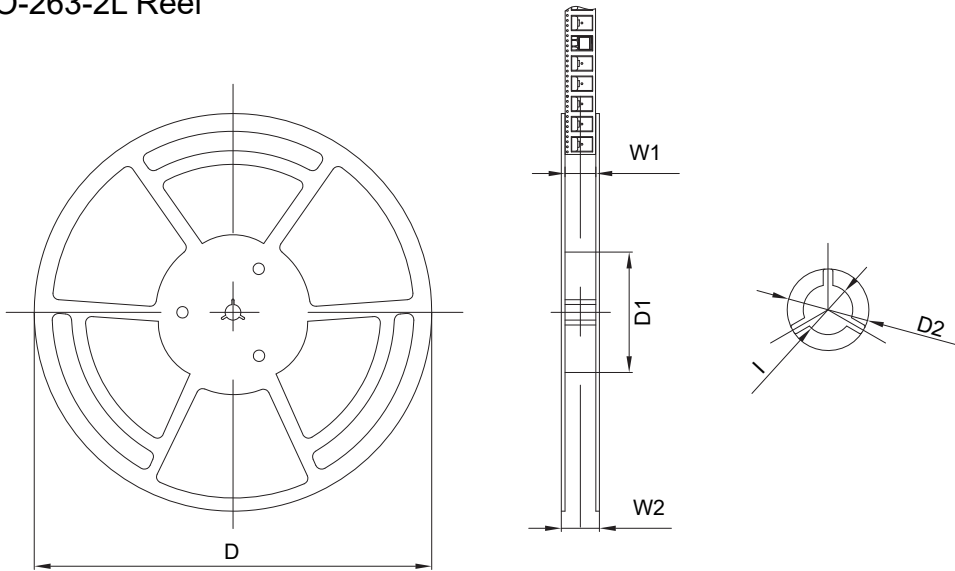

Dimensions are in millimeter						
Reel	D	D1	D2	W1	W2	I
13" Dia	330.00	100.00	Φ21.00	24.40	30.40	Φ13.00

Reel	Reel Size	Box	Box Size(mm)	Carton	Carton Size(mm)
800 pcs	13 inch	1600 pcs	360×360×65	8000 pcs	378×358×382