



TO-263-2L Plastic-Encapsulate Diode

SBDB40H150CTB

SCHOTTKY BARRIER RECTIFIER

MAIN CHARACTERISTICS

| | |
|--------------|--------------------------|
| I_o | 40 (20×2) A |
| V_{RRM} | 150 V |
| T_j | 175 °C |
| $V_{F(typ)}$ | 0.67V (@Ta=150°C) |

FEATURES

- Low Power Loss,High Efficiency
- Guard Ring Die Construction for Transient Protection
- High Current Capability and Low Forward Voltage Drop

MARKING

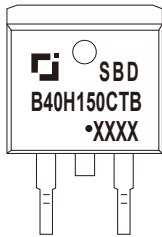

SBDB40H150CTB = Device code
 Solid dot = Green molding compound device
 if none, the normal device
 XXXX = Code

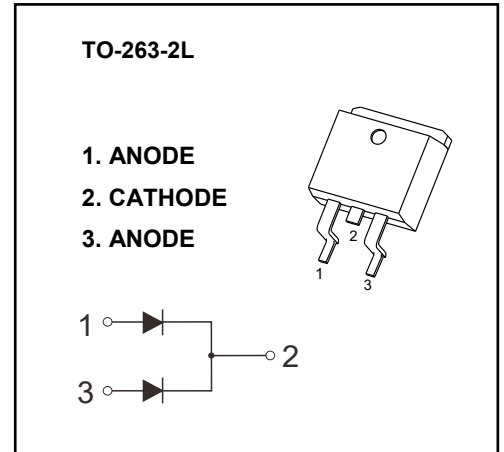

MAXIMUM RATINGS ($T_a=25^\circ\text{C}$ unless otherwise noted)

| Symbol | Parameter | Value | Unit |
|-----------------|---|----------|---------------------------|
| V_{RRM} | Peak repetitive reverse voltage | 150 | V |
| V_{RWM} | Working peak reverse voltage | | |
| V_R | DC blocking voltage | | |
| $V_{R(RMS)}$ | RMS reverse voltage | 106 | V |
| I_o | Average rectified output current | 40 | A |
| I_{FSM} | Non-Repetitive peak forward surge current (8.3ms half sine wave) | 300 | A |
| $R_{\theta JC}$ | Thermal resistance from junction to case , $T_c=25^\circ\text{C}$ | 2.0 | $^\circ\text{C}/\text{W}$ |
| $R_{\theta JA}$ | Thermal resistance from junction to ambient | 62.5 | $^\circ\text{C}/\text{W}$ |
| T_j | Junction temperature | 175 | $^\circ\text{C}$ |
| T_{stg} | Storage temperature | -55~+175 | $^\circ\text{C}$ |

ELECTRICAL CHARACTERISTICS ($T_a=25^\circ\text{C}$ unless otherwise specified)

| Parameter | Symbol | Test conditions | Min | Typ | Max | Unit |
|-----------------|------------|--------------------|-------------------------|------|------|------|
| Reverse voltage | $V_{(BR)}$ | $I_R=0.1\text{mA}$ | 150 | | | V |
| Reverse current | I_R | $V_R=150\text{V}$ | $T_j=25^\circ\text{C}$ | 200 | 500 | nA |
| | | | $T_j=150^\circ\text{C}$ | 1.2 | | mA |
| Forward voltage | V_F | $I_F=10\text{A}$ | $T_j=25^\circ\text{C}$ | 0.79 | | V |
| | | | $T_j=150^\circ\text{C}$ | 0.66 | | V |
| | | $I_F=20\text{A}$ | $T_j=25^\circ\text{C}$ | 0.82 | 0.88 | V |
| | | | $T_j=150^\circ\text{C}$ | 0.67 | | V |

*Pulse test: pulse width $\leq 300\mu\text{s}$, duty cycles $\leq 2.0\%$.

Typical Characteristics

Forward Current Derating Curve

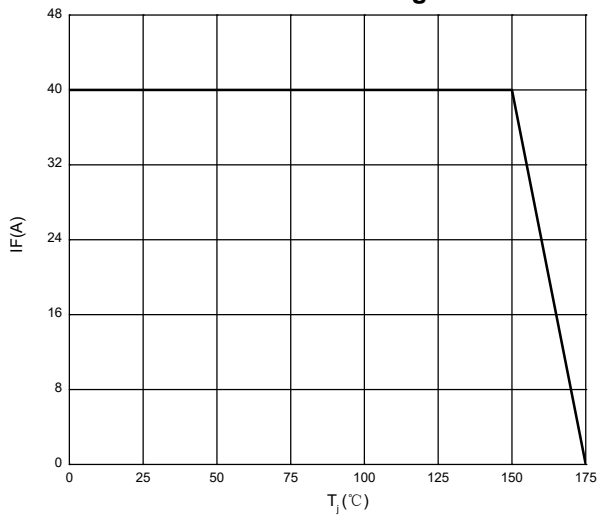

Forward Characteristics

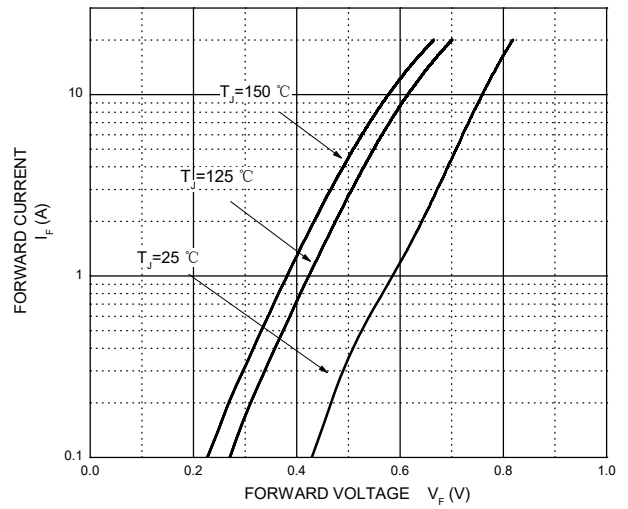

Reverse Characteristics

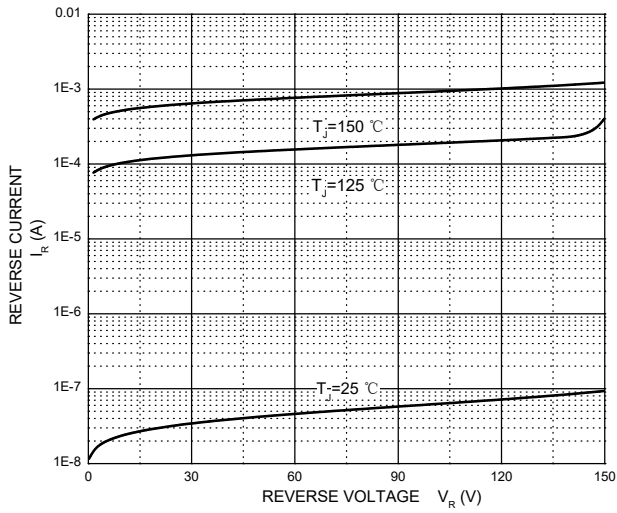

Capacitance Characteristics Per Diode

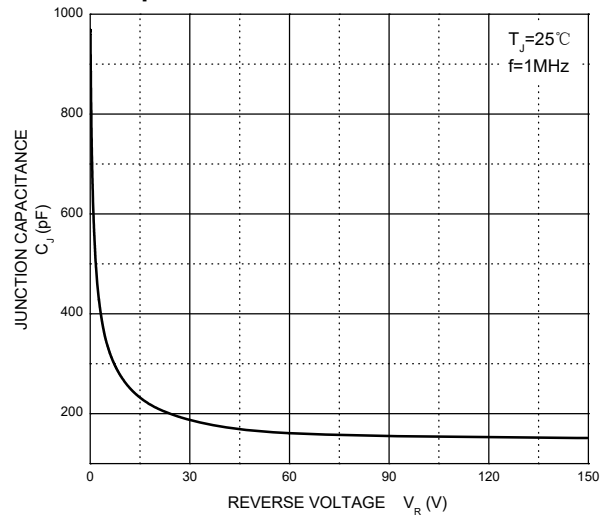

TO-263-2L Package Outline Dimensions

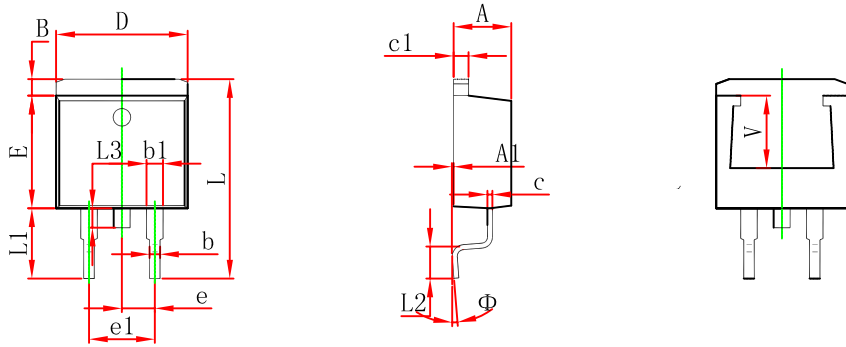

| Symbol | Dimensions In Millimeters | | Dimensions In Inches | |
|--------|---------------------------|--------|----------------------|-------|
| | Min. | Max. | Min. | Max. |
| A | 4.470 | 4.670 | 0.176 | 0.184 |
| A1 | 0.000 | 0.150 | 0.000 | 0.006 |
| B | 1.120 | 1.420 | 0.044 | 0.056 |
| b | 0.710 | 0.910 | 0.028 | 0.036 |
| b1 | 1.170 | 1.370 | 0.046 | 0.054 |
| c | 0.310 | 0.530 | 0.012 | 0.021 |
| c1 | 1.170 | 1.370 | 0.046 | 0.054 |
| D | 10.010 | 10.310 | 0.394 | 0.406 |
| E | 8.500 | 8.900 | 0.335 | 0.350 |
| e | 2.540 TYP. | | 0.100 TYP. | |
| e1 | 4.980 | 5.180 | 0.196 | 0.204 |
| L | 14.940 | 15.500 | 0.588 | 0.610 |
| L1 | 4.950 | 5.450 | 0.195 | 0.215 |
| L2 | 2.340 | 2.740 | 0.092 | 0.108 |
| L3 | 1.300 | 1.700 | 0.051 | 0.067 |
| Φ | 0° | 8° | 0° | 8° |
| V | 5.600 REF. | | 0.220 REF. | |

TO-263-2L Suggested Pad Layout

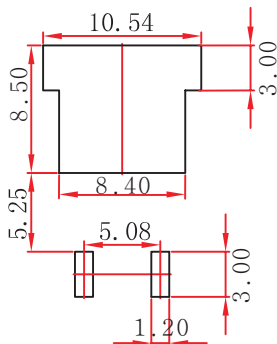

Note:

1. Controlling dimension: in millimeters.
2. General tolerance: $\pm 0.05\text{mm}$.
3. The pad layout is for reference purposes only.

NOTICE

JSCJ reserves the right to make modifications, enhancements, improvements, corrections or other changes without further notice to any product herein. JSCJ does not assume any liability arising out of the application or use of any product described herein.

TO-263-2L Tape and Reel

TO-263-2L Embossed Carrier Tape



Packaging Description:

TO-263-2L parts are shipped in tape. The carrier tape is made from a dissipative (carbon filled) polycarbonate resin. The cover tape is a multilayer film (Hear Activated Adhesive in nature) primarily composed of polyester film, adhesive layer, sealant, and anti-static sprayed agent. These reeled parts in standard option are shipped with 800 units per 13" or 33.0 cm diameter reel. The reels are clear in color and is made of polystyrene plastic (anti-static coated).

| Dimensions are in millimeter | | | | | | | | | | |
|------------------------------|-------|-------|------|-------|------|-------|------|-------|------|-------|
| Pkg type | A | B | C | d | E | F | P0 | P | P1 | W |
| TO-263 | 10.80 | 16.13 | 5.21 | Φ1.55 | 1.75 | 11.50 | 4.00 | 16.00 | 2.00 | 24.00 |

TO-263-2L Tape Leader and Trailer



TO-263-2L Reel

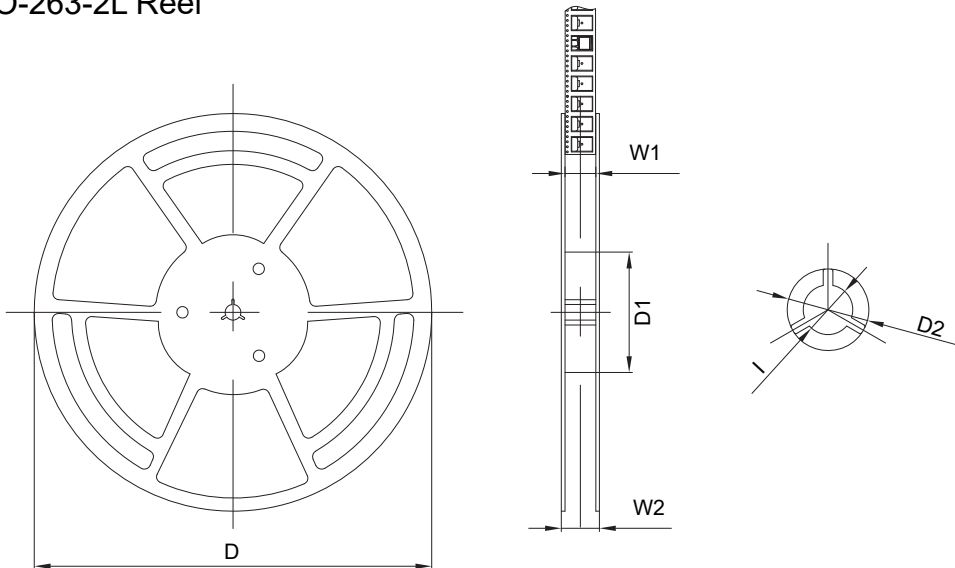

| Dimensions are in millimeter | | | | | | |
|------------------------------|--------|--------|--------|-------|-------|--------|
| Reel | D | D1 | D2 | W1 | W2 | l |
| 13" Dia | 330.00 | 100.00 | Φ21.00 | 24.40 | 30.40 | Φ13.00 |

| Reel | Reel Size | Box | Box Size(mm) | Carton | Carton Size(mm) |
|---------|-----------|----------|--------------|----------|-----------------|
| 800 pcs | 13 inch | 1600 pcs | 360×360×65 | 8000 pcs | 378×358×382 |