



**SBD20200CTB、SBDF20200CTB**

SCHOTTKY BARRIER RECTIFIER

**MAIN CHARACTERISTICS**

$I_O$	20(10×2)A
$V_{RRM}$	200 V
$T_j$	150 °C
$V_{F(typ)}$	0.69V (@ $T_j=125^{\circ}C$ )

**FEATURES**

- Low Power Loss,High Efficiency
- Guard Ring Die Construction for Transient Protection
- High Current Capability and Low Forward Voltage Drop

**MARKING**

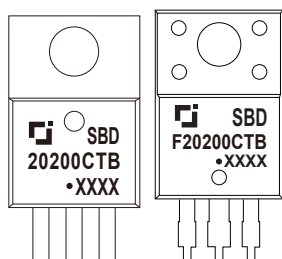

SBD(F)20200CTB = Device code  
 Solid dot = Green molding compound device  
 if none, the normal device  
 XXXX = Code

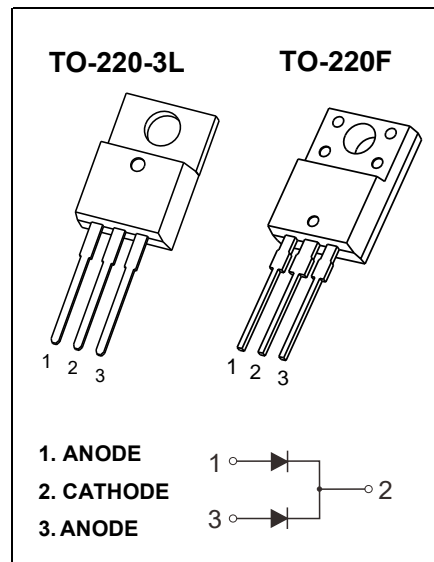

**MAXIMUM RATINGS (  $T_a=25^{\circ}C$  unless otherwise noted )**

Symbol	Parameter	SBD		Unit
		20200CTB	F20200CTB	
$V_{RRM}$	Peak repetitive reverse voltage	200		V
$V_{RWM}$	Working peak reverse voltage			
$V_R$	DC blocking voltage			
$V_{R(RMS)}$	RMS reverse voltage	140		V
$I_O$	Average rectified output current	20		A
$I_{FSM}$	Non-Repetitive peak forward surge current (8.3ms half sine wave)	200		A
$R_{\theta Jc}$	Thermal resistance from junction to case , $T_c=25^{\circ}C$	2.0	3.0	$^{\circ}C/W$
$R_{\theta JA}$	Thermal resistance from junction to ambient	75		$^{\circ}C/W$
$T_j$	Junction temperature	150		$^{\circ}C$
$T_{stg}$	Storage temperature	-55~+150		$^{\circ}C$

**ELECTRICAL CHARACTERISTICS (  $T_a=25^{\circ}C$  unless otherwise specified)**

Parameter	Symbol	Test conditions	Min	Typ	Max	Unit
Reverse voltage	$V_{(BR)}$	$I_R=0.1mA$	200			V
Reverse current	$I_R$	$V_R=200V$	$T_j = 25^{\circ}C$	0.5	5.0	$\mu A$
			$T_j = 125^{\circ}C$	1.0		mA
Forward voltage	$V_F$	$I_F=5A$	$T_j = 25^{\circ}C$	0.78		V
			$T_j = 125^{\circ}C$	0.63		V
		$I_F=10A$	$T_j = 25^{\circ}C$	0.84	0.90	V
			$T_j = 125^{\circ}C$	0.69		V
Total Capacitance	$C_{tot}$	$V_R=0V, f=1MHz$		359		pF

\*Pulse test: pulse width  $\leq 300\mu s$ , duty cycles  $\leq 2.0\%$ .

# Typical Characteristics

FIG.1: FORWARD CURRENT DERATING CURVE

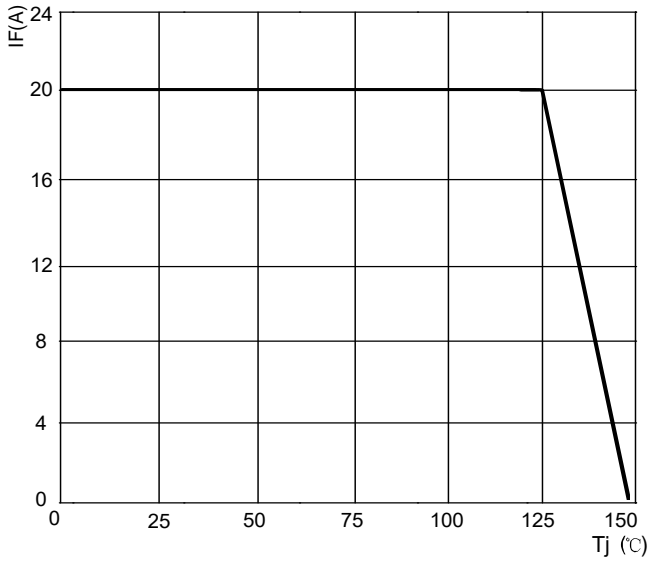

FIG.2: TYPICAL FORWARD CHARACTERISTICS

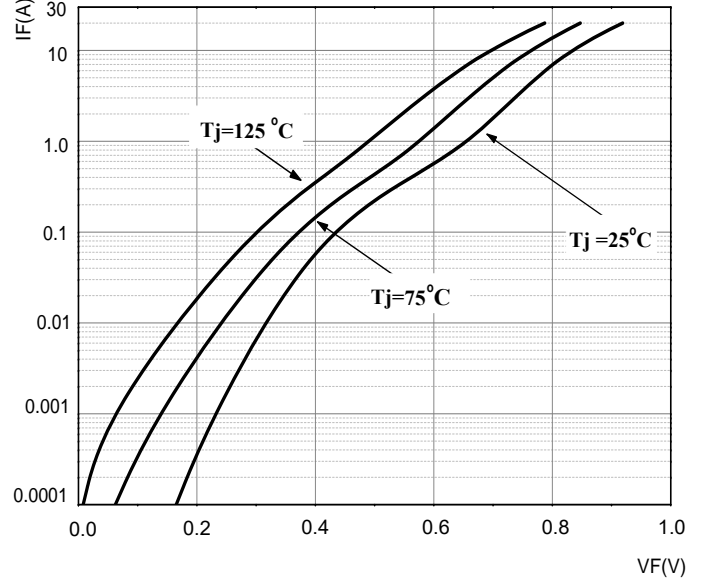

FIG.3: TOTAL CAPACITANCE DERATING CURVE

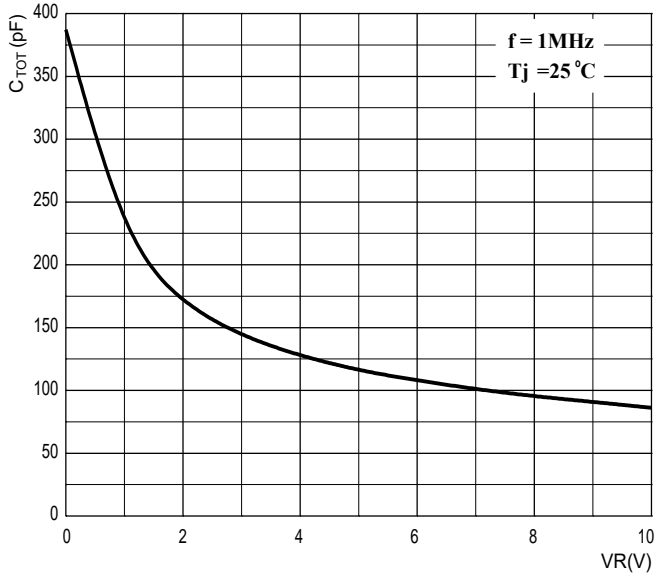
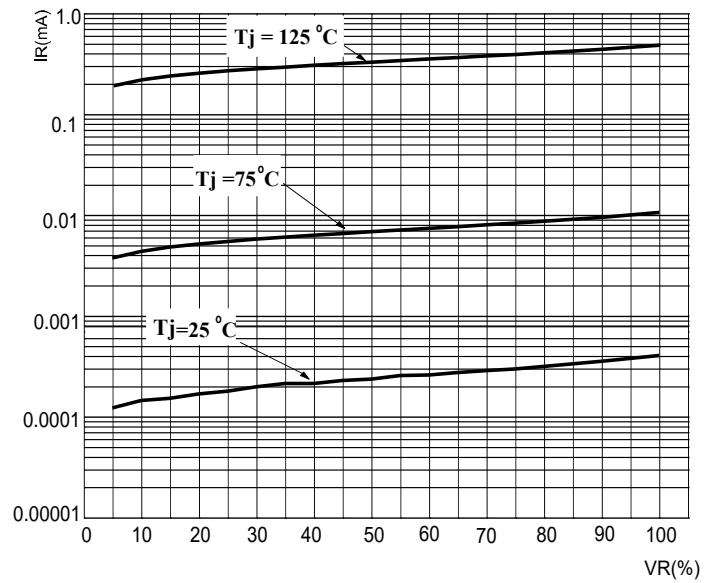
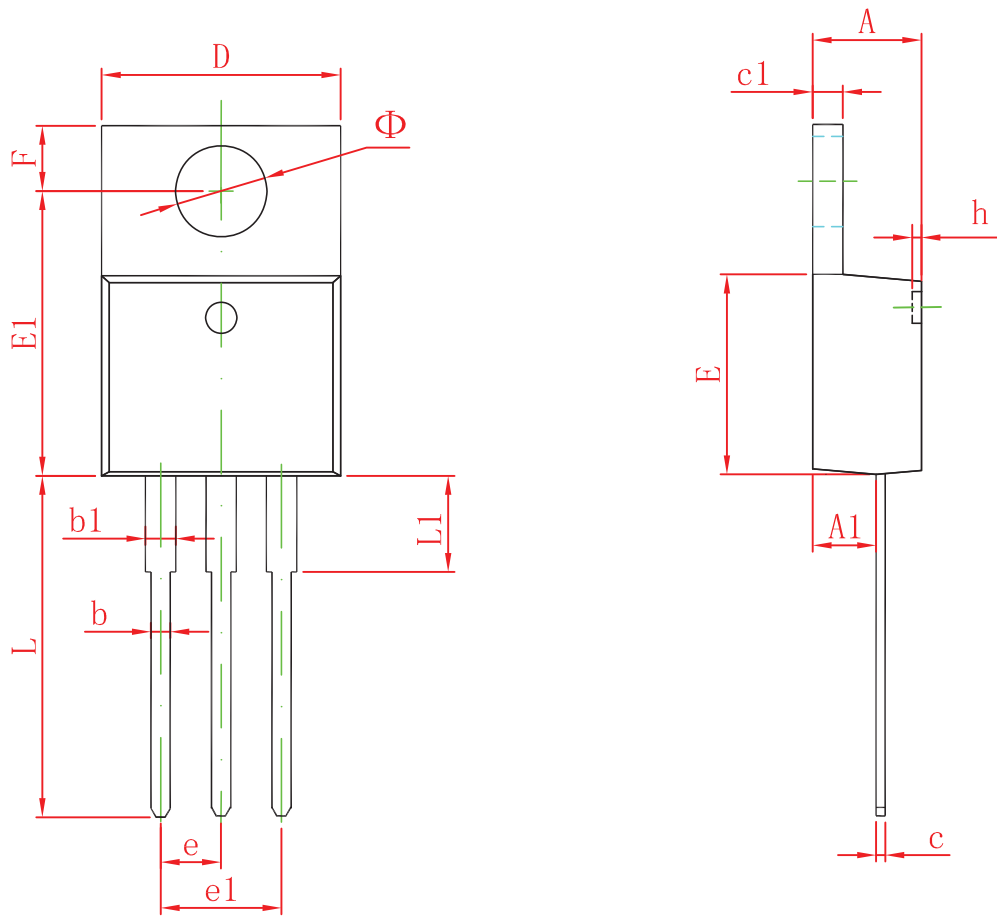

FIG.4: TYPICAL REVERSE CHARACTERISTICS



# TO-220-3L Package Outline Dimensions



Symbol	Dimensions In Millimeters		Dimensions In Inches	
	Min	Max	Min	Max
A	4.450	4.750	0.175	0.187
A1	2.520	2.820	0.099	0.111
b	0.710	0.910	0.028	0.036
b1	1.170	1.370	0.046	0.054
c	0.300	0.500	0.012	0.020
c1	1.170	1.370	0.046	0.054
D	9.830	10.330	0.387	0.407
E	8.500	8.900	0.335	0.350
E1	12.050	12.650	0.474	0.498
e	2.540 TYP		0.100 TYP	
e1	4.900	5.200	0.192	0.205
F	2.540	2.940	0.100	0.116
h	0.100 TYP		0.004 TYP	
L	13.300	13.800	0.523	0.543
L1	3.540	3.940	0.139	0.155
Φ	3.735	3.935	0.147	0.155

# TO-220F Package Outline Dimensions



Symbol	Dimensions In Millimeters		Dimensions In Inches	
	Min.	Max.	Min.	Max.
A	4.300	4.700	0.169	0.185
A1	1.300 REF.		0.051 REF.	
A2	2.800	3.200	0.110	0.126
A3	2.500	2.900	0.098	0.114
b	0.500	0.750	0.020	0.030
b1	1.100	1.350	0.043	0.053
b2	1.500	1.750	0.059	0.069
c	0.500	0.750	0.020	0.030
D	9.960	10.360	0.392	0.408
E	14.800	15.200	0.583	0.598
e	2.540 TYP.		0.100 TYP.	
F	2.700 REF.		0.106 REF.	
$\Phi$	3.300	3.700	0.130	0.146
L	28.000	28.400	1.102	1.118
L1	1.700	1.900	0.067	0.075
L2	0.900	1.100	0.035	0.043