

TO-247 Plastic-Encapsulate Diode

SBDW60H150CTB SCHOTTKY BARRIER RECTIFIER

MAIN CHARACTERISTICS

I_o	60A (2×30) A
V_{RRM}	150V
T_j	175 °C
$V_{F(typ)}$	0.68V (@$T_j=150^{\circ}C$)

FEATURES

- Low Power Loss, High Efficiency
- Guard Ring Die Construction for Transient Protection
- High Current Capability and Low Forward Voltage Drop

MARKING

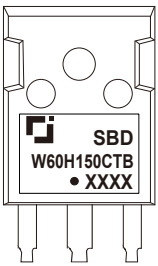

SBDW60H150CTB= Device code
 Solid dot = Green molding compound device
 if none, the normal device
 XXXX= Code

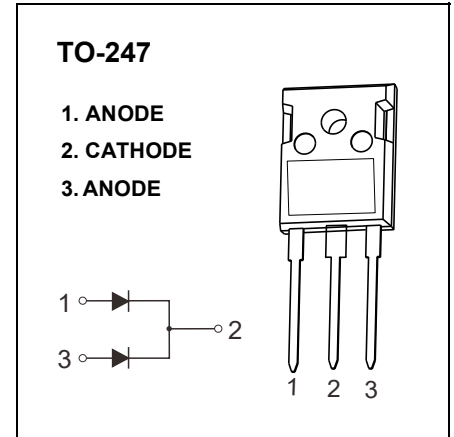

MAXIMUM RATINGS ($T_a=25^{\circ}C$ unless otherwise noted)

Symbol	Parameter	Value	Unit
V_{RRM}	Peak repetitive reverse voltage	150	V
V_{RWM}	Working peak reverse voltage		
V_R	DC blocking voltage		
$V_{R(RMS)}$	RMS reverse voltage	105	V
I_o	Average rectified output current	60	A
I_{FSM}	Non-Repetitive peak forward surge current (8.3ms half sine wave)	500	A
$R_{\theta JC}$	Thermal resistance from junction to case	0.6	$^{\circ}C/W$
$R_{\theta JA}$	Thermal resistance from junction to ambient	40	$^{\circ}C/W$
T_j	Junction temperature	175	$^{\circ}C$
T_{stg}	Storage temperature	-55~+175	$^{\circ}C$

ELECTRICAL CHARACTERISTICS ($T_a=25^{\circ}C$ unless otherwise specified)

Parameter	Symbol	Test conditions	Min	Typ	Max	Unit
Reverse voltage	$V_{(BR)}$	$I_R=1mA$	150			V
Reverse current	I_R	$V_R=150V$	$T_j=25^{\circ}C$	0.1	2.5	μA
			$T_j=150^{\circ}C$	0.8		mA
Forward voltage	V_F	$I_F=15A$	$T_j=25^{\circ}C$	0.77		V
			$T_j=150^{\circ}C$	0.60		V
		$I_F=30A$	$T_j=25^{\circ}C$	0.83	0.88	V
			$T_j=150^{\circ}C$	0.68		V

*Pulse test: pulse width $\leq 300\mu s$, duty cycle $\leq 2.0\%$.

Typical Characteristics

Current Derating

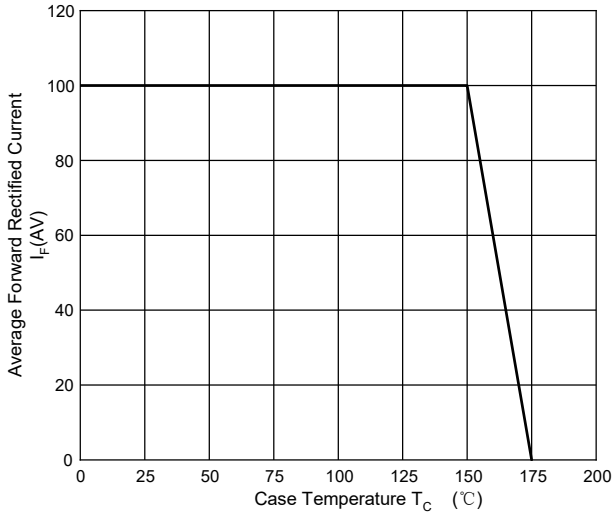

Forward Characteristics

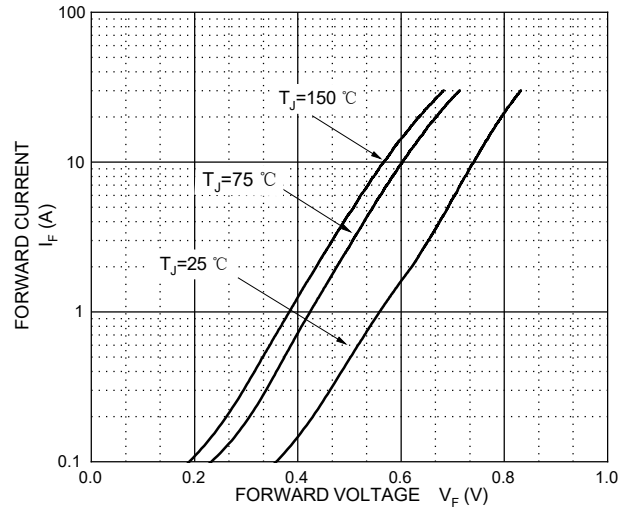

Reverse Characteristics

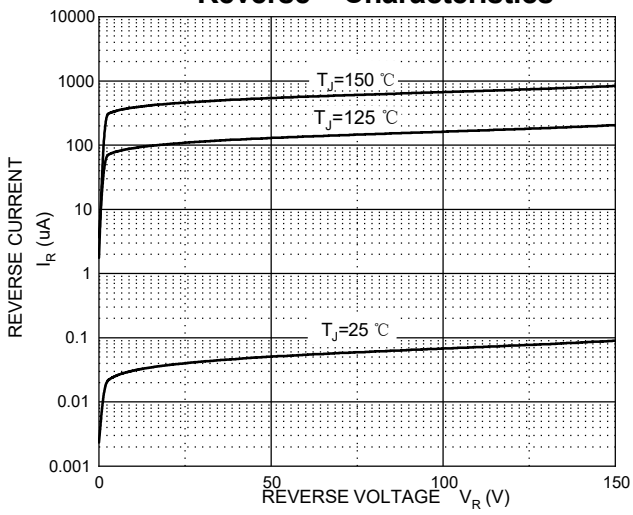

Capacitance Characteristics Per Diode

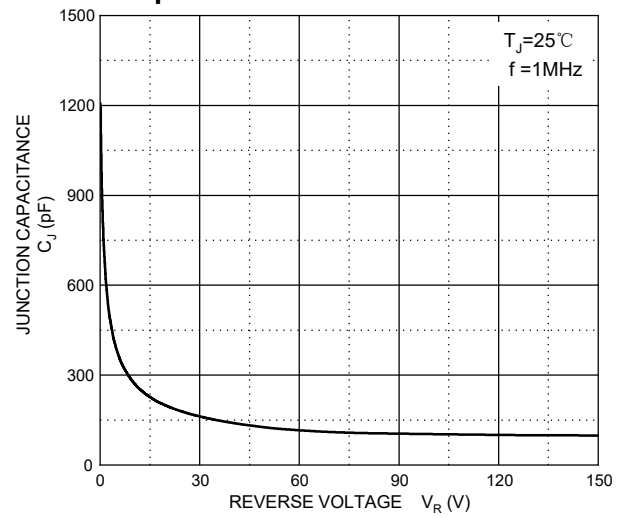

TO-247 Package Outline Dimensions

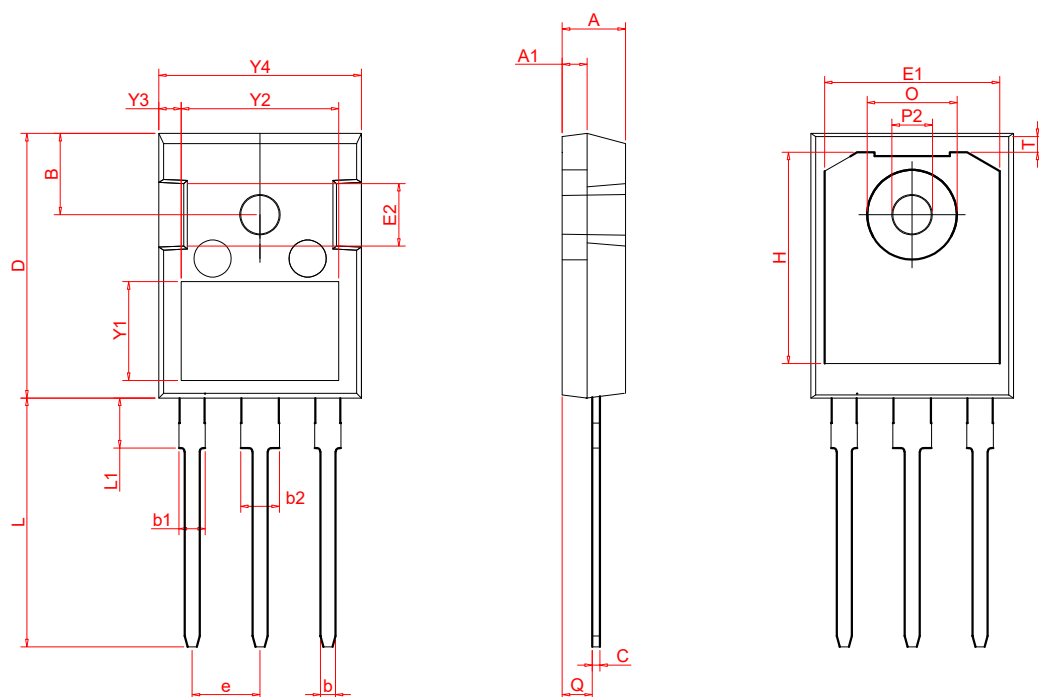

Symbol	Dimensions In Millimeters		Dimensions In Inches	
	Min	Max	Min	Max
A	4.700	5.300	0.185	0.209
A1	1.700	2.300	0.067	0.091
C	0.450	0.750	0.018	0.030
Q	2.200	2.600	0.087	0.102
O	7.100	7.400	0.280	0.291
P2	3.450	3.750	0.136	0.148
L	19.000	21.000	0.748	0.827
L1	4.2	4.5	0.165	0.177
b	1.000	1.400	0.039	0.055
b1	1.800	2.250	0.071	0.089
b2	3.000	3.300	0.118	0.130
e	5.250	5.550	0.207	0.219
D	20.950	21.350	0.825	0.841
Y1	7.600	8.100	0.299	0.319
Y2	11.000	13.000	0.433	0.512
Y3	1.750	2.250	0.069	0.089
Y4	16.000	16.400	0.630	0.646
E2	4.600	4.900	0.181	0.193
T	1.35REF		0.053REF	
H	16.25REF		0.639REF	
E1	14REF		0.551REF	
B	6.55REF		0.257REF	