

TO-277 Plastic-Encapsulate Diodes

SP2060L Schottky Rectifier Diode

Features

- $I_{F(AV)}$ 20A
- V_{RRM} 60V
- High surge current capability
- Low peak forward voltage

Applications

- Rectifier

Marking

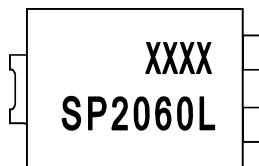

XXXX=code
SP2060L=Device code

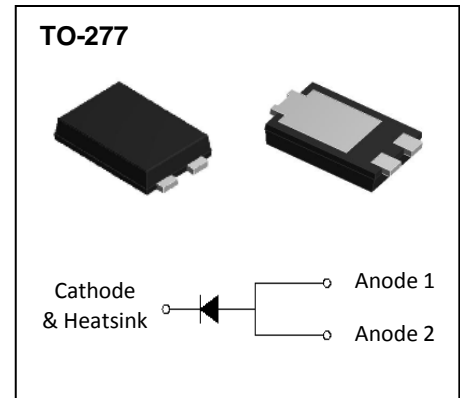

Limiting Values(Absolute Maximum Rating)

Item	Symbol	Unit	Test Conditions	SP2060L
Repetitive Peak Reverse Voltage	V_{RRM}	V		60
Maximum RMS Voltage	V_{RMS}	V		42
Average Forward Current	$I_{F(AV)}$	A	60Hz Half-sine wave, Resistance load, $T_a=125^\circ\text{C}$	20
Surge(Non-repetitive)Forward Current	I_{FSM}	A	60Hz Half-sine wave, 1 cycle, $T_a=25^\circ\text{C}$	300
Junction Temperature	T_J	$^\circ\text{C}$		-55 ~ +150
Storage Temperature	T_{STG}	$^\circ\text{C}$		-55 ~ +150

Electrical Characteristics ($T=25^\circ\text{C}$ Unless otherwise specified)

Item	Symbol	Unit	Test Condition	SP2060L	
Peak Forward Voltage	V_F	V	$I_F=20.0A$	$T_a=25^\circ\text{C}$	0.54(TYP) 0.56(MAX)
				$T_a=125^\circ\text{C}$	0.48(TYP) 0.50(MAX)
Peak Reverse Current	I_{RRM1}	mA	$V_{RM}=V_{RRM}$	$T_a=25^\circ\text{C}$	0.08(TYP) 0.10(MAX)
	I_{RRM2}			$T_a=125^\circ\text{C}$	60(TYP) 80(MAX)
Thermal Resistance(Typical)	$R_{\theta J-A}$	$^\circ\text{C}/\text{W}$	Between junction and ambient	30	
	$R_{\theta J-L}$		Between junction and terminal	1	
Typical junction capacitance	C_J	nF	$V_R=4.0\text{ V}, f=1\text{ MHz}$	0.95	

Notes:

Thermal resistance from junction to ambient and from junction to lead mounted on P.C.B. with 0.3" x 0.3" (8.0 mm x 8.0 mm) copper pad areas

Typical Characteristics

FIG.1: FORWARD CURRENT DERATING CURVE

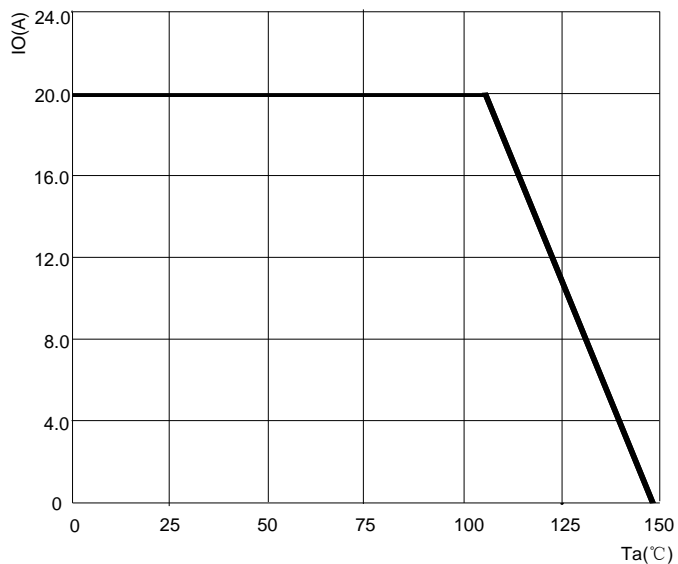

FIG.2: MAXIMUM NON-REPETITIVE FORWARD SURGE CURRENT

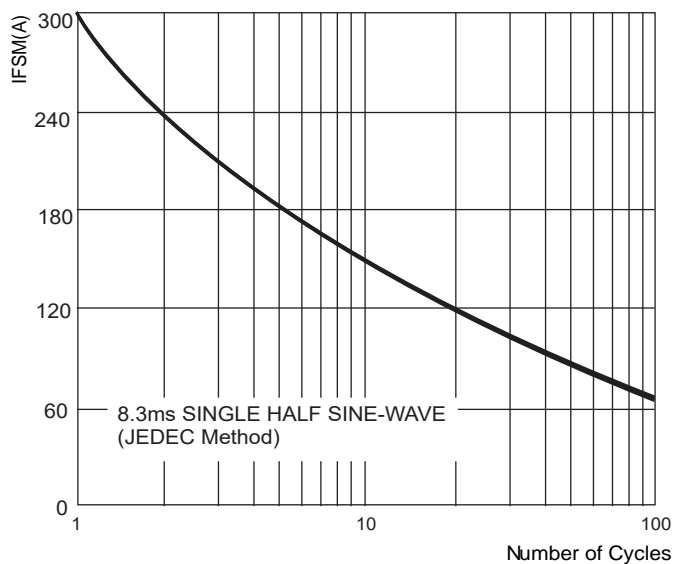

FIG.3: INSTANTANEOUS FORWARD CHARACTERISTICS

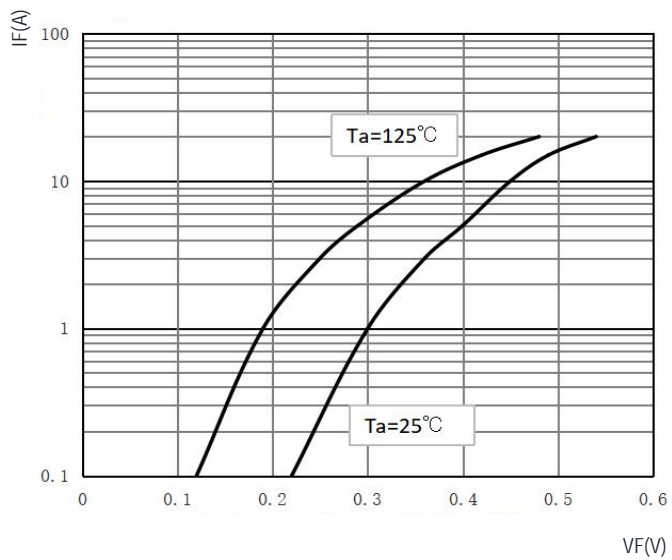
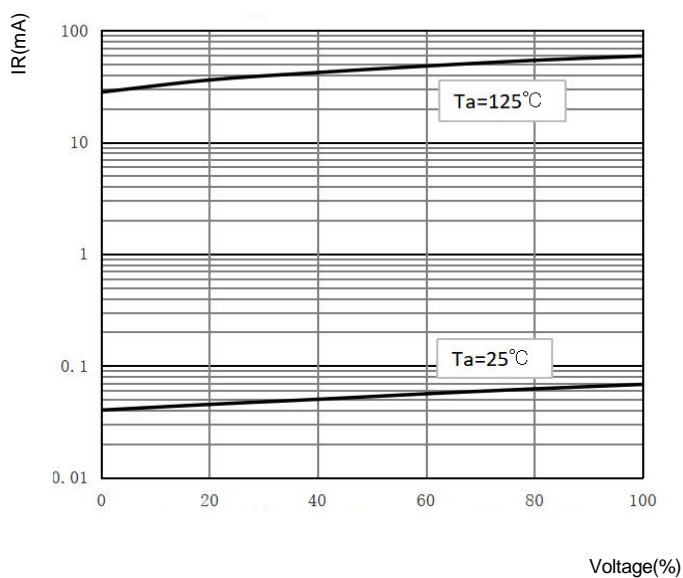
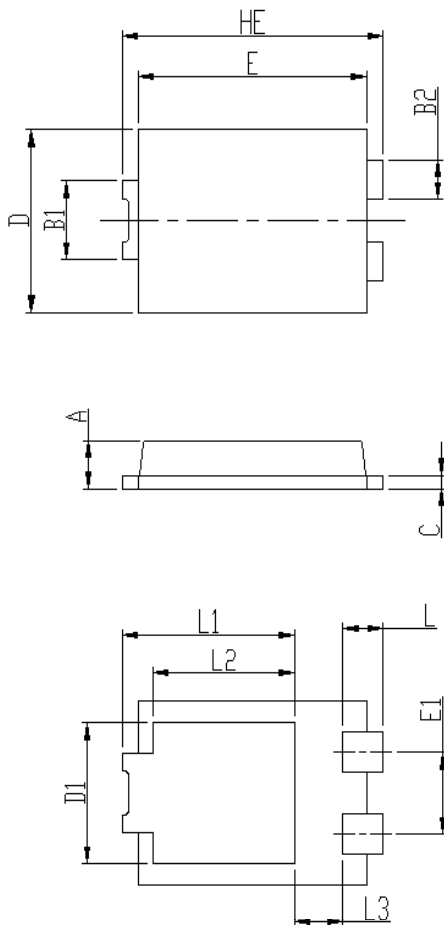

FIG.4: TYPICAL REVERSE CHARACTERISTICS



TO- 277 Package Outline Dimensions



DIM	Unit: mm		Unit: inch	
	MIN	MAX	MIN	MAX
HE	6.4	6.6	0.252	0.260
E	5.6	5.8	0.220	0.228
D	4.1	4.3	0.161	0.169
B1	1.7	1.9	0.067	0.075
B2	0.8	1	0.031	0.039
A	1.05	1.2	0.041	0.047
C	0.3	0.4	0.012	0.016
L	0.85	1.1	0.033	0.043
L1	4.2	4.4	0.165	0.173
L2	3.52 Typ.		0.139 Typ.	
L3	1.1	1.4	0.043	0.055
D1	3	3.3	0.118	0.130
E1	1.86 Typ.		0.073 Typ.	

TO- 277 Suggested Pad Layout

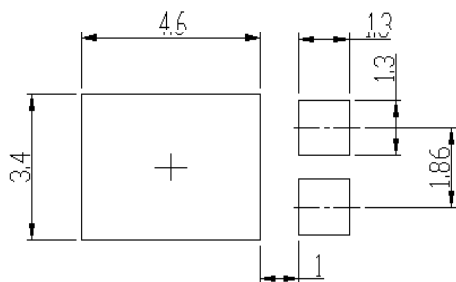

Note:

1. Controlling dimension: in millimeters.
2. General tolerance: ± 0.05 mm.
3. The pad layout is for reference purposes only.

NOTICE

JSCJ reserves the right to make modifications, enhancements, improvements, corrections or other changes without further notice to any product herein. JSCJ does not assume any liability arising out of the application or use of any product described herein.